

Proportional rotary solenoid

6

Product group

G DR

- **Proportional rotary solenoid**
- According to DIN VDE 0580
- Horizontal torque vs. rotation angle characteristic
- Constant torque in the working area
- Proportional relation between torque and current
- Short correcting times through pre-magnetized system
- Clockwise and anti clockwise by reversing the polarity
- Armature guided in ball bearings
- Exciter coil corresponds to insulation class B
- Electrical connection and protection class with duly executed installation
 - free flexible lead ends
 Protection classes according to DIN VDE 0470-1/
DIN EN 60529 - IP 20
- Fastening with tapped holes on the front sides
- Possibility to flange-mount of a return spring
- **Rotation angle position sensor**
- Flow measuring by means of Hall sensor with integrated electronics
- Limit frequency of the Hall sensor: typically 23 kHz
- Measuring range up to 110°
- Stable sensor housing made of aluminium
- Flange-mounting by centering shoulder and two screws
- Electrical connection and protection class with duly executed installation:
 - Free, flexible lead ends
 Protection class according to DIN VDE 0470-1/
DIN EN 60529 - IP 20
- Design with programmable Hall sensor on request
- Please contact us for modifications and special designs
- **Application examples:**
Drive for industrial control units, control technology, rotary slides and flap valves in fluid technology.
The combination proportional solenoid with rotation angle position sensor allows the use of the rotary solenoid for closed loop control system.



Fig. 1: Type G DR X 050 X20 A01
Without rotation position sensor



Fig. 2: Type G DR X 050 X20 A61
With rotation position sensor

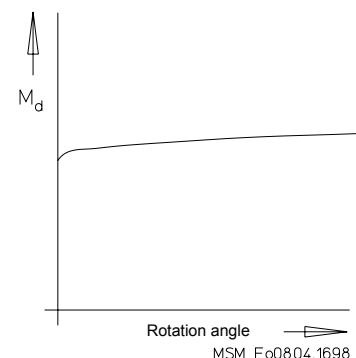

Fig. 3: Torque characteristic



QUALITY SINCE 1912

Technical data proportional rotary solenoids of the series G DR

G DR X	035					050					075				
Rated voltage U_N (V)	24														
Operating mode ED	S1 100 %	S3 40 %	S3 25 %	S3 15 %	S3 5 %	S1 100 %	S3 40 %	S3 25 %	S3 15 %	S3 5 %	S1 100 %	S3 40 %	S3 25 %	S3 15 %	S3 5 %
Rated power P_{20} (W)	6,6	15,6	24,6	37	80	11	21	40	65	144	25	50	82	146	331
Torque M_d (Ncm)	2,1	3,3	4,1	5,1	7,2	6	8,6	11,6	16	23	24	35	48	61	85
Reference temperature ϑ_{11} (°C)	35														
Rotation angle (°)	110														
Mass m (kg)	0,156														
Moment of inertia of the armature J (kgm ²)	$1,9 \times 10^{-6}$														

Technical data	G DR X 035 X 20 A 61
Rotation angle position sensor on proportional rotary solenoids	G DR X 050 X 20 A 61 G DR X 075 X 20 A 61
Measuring range (°)	±55
Supply voltage (V)	4,5 ... 6
Current consumption (mA)	<14
Output voltage (V)	1,8 ... 3,1
In central position (V)	2,5±0,25
Sensitivity (mV/1°)	typically 11±1
Linearity tolerance (%)	±3
Limit frequency (-3 dB) (kHz)	typically 23
Reference temperature range (°C)	0 ... 50
Temperature drift (%/°C)	typically 0,05
Output resistance (Ω)	50

e.g. at $U_{Supply} = 5 V$

Sensitivity
The sensitivity is the change output signal referring to the measurement path (indicated in mV/1°).

Linearity fault
Linearity fault indicates the deviation (in per cent) of the output signal from the ideal straight line

Temperature drift
Temperature drift indicates the deviation (in per cent) of the output signal per degree of the temperature change (indicated in %/°C).

Limit frequency
In reference to the Hall sensor

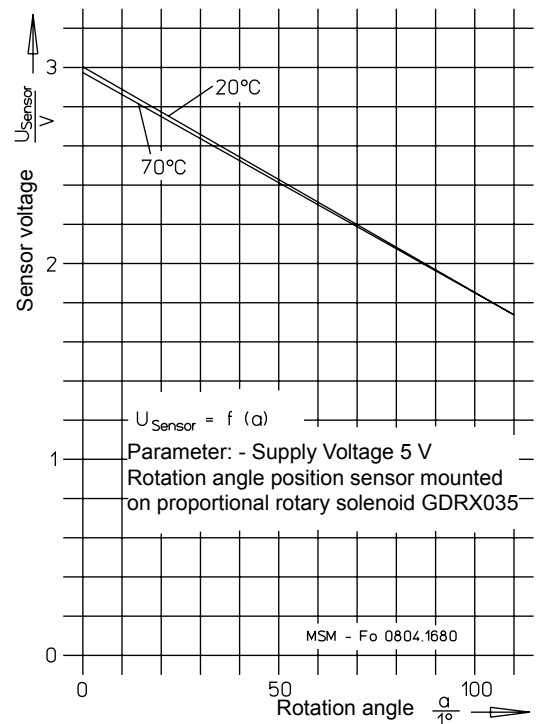

Fig. 4: Voltage vs. rotation angle characteristic of rotation angle position sensor

Serial values

The torque values indicated in the table refer to 90% of the rated voltage of 24 V and to the normal operating temperature. For other voltages the torque may differ. Due to natural dispersion the torque values may deviate by ±10% from the values indicated in the tables. Rated voltage 24V, other voltages on request.

The normal operating temperature is based on:

- Mounting on heat-insulating base
- Rated voltage 24 V
- Operating mode S3 5% - S1 according to part list G XX section 4
- Reference temperature 35°C

It is advisable to do not limit bigger masses connected to the shaft by means of stops inside the solenoid but outside.

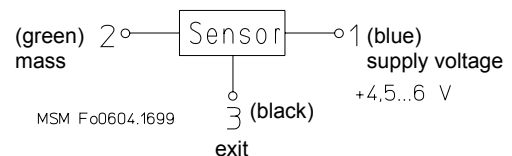

Fig 5: Block diagram



Type G DR X 035

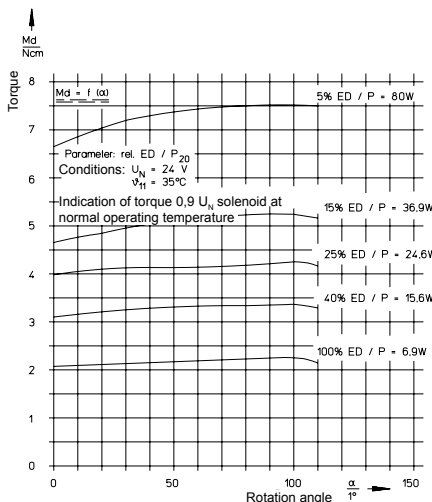

Fig. 6: Characteristics $M_d = f(\alpha)$
Type G DR X 035
MSM-Fo 0804.1692

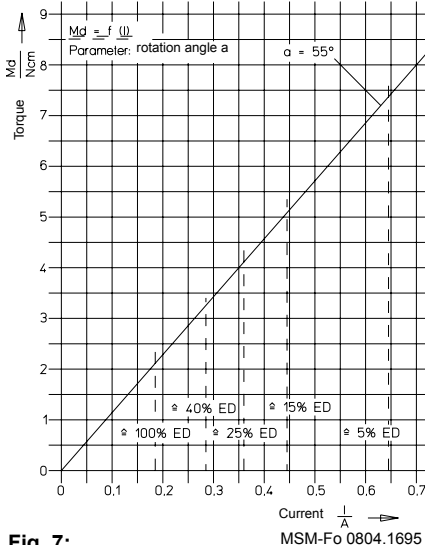

Fig. 7: Characteristics $M_d = f(I)$
Type G DR X 035
MSM-Fo 0804.1695

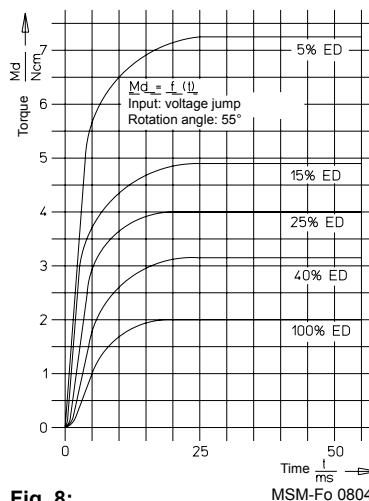

Fig. 8: Characteristics $M_d = f(t)$
Type G DR X 035
MSM-Fo 0804.1675

Type G DR X 050

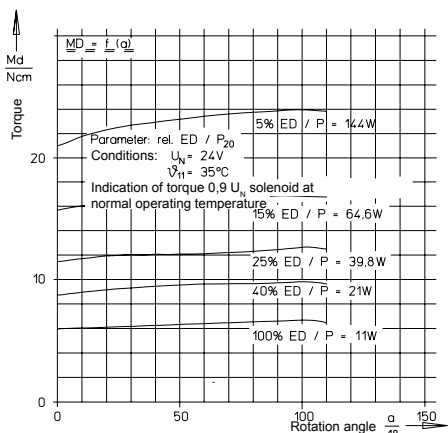

Fig. 9: Characteristics $M_d = f(\alpha)$
Type G DR X 050
MSM-Fo 0804.1693

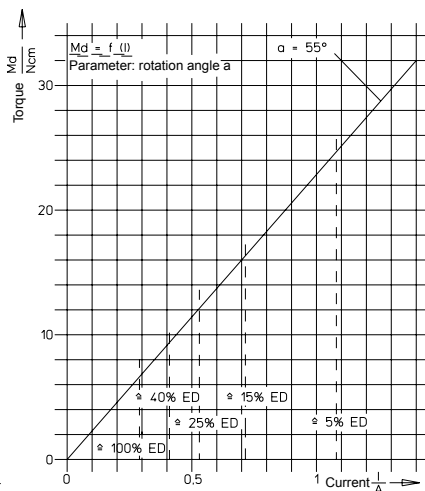

Fig. 10: Characteristics $M_d = f(I)$
Type G DR X 050
MSM-Fo 0804.1696

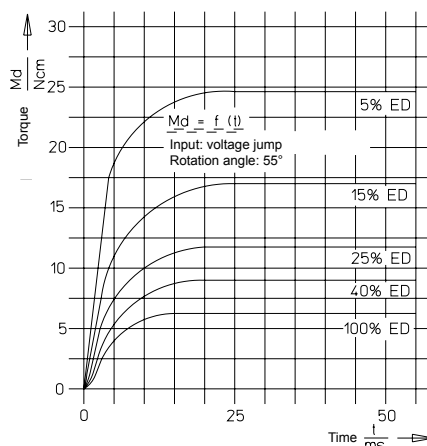

Fig. 11: Characteristics $M_d = f(t)$
Type G DR X 050
MSM-Fo 0804.1676

Type G DR X 075

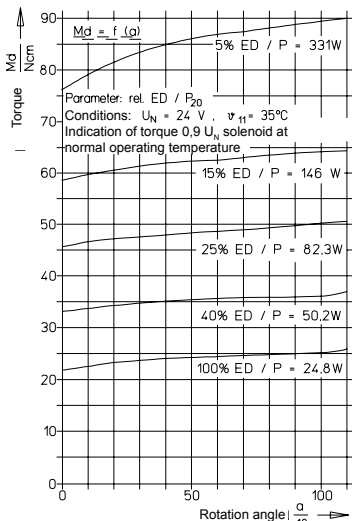

Fig. 12: Characteristics $M_d = f(\alpha)$
Type G DR X 075
MSM-Fo 0804.1694

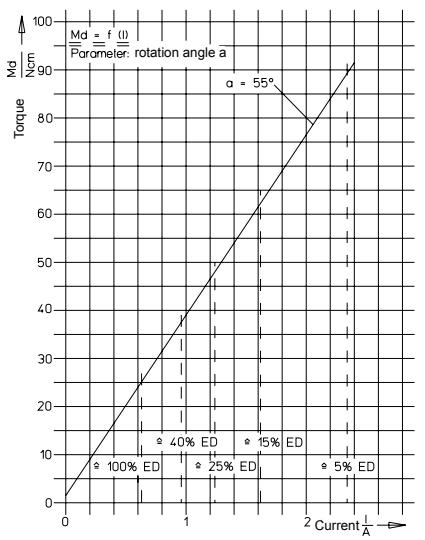

Fig. 13: Characteristics $M_d = f(I)$
Type G DR X 075
MSM-Fo 0804.1697

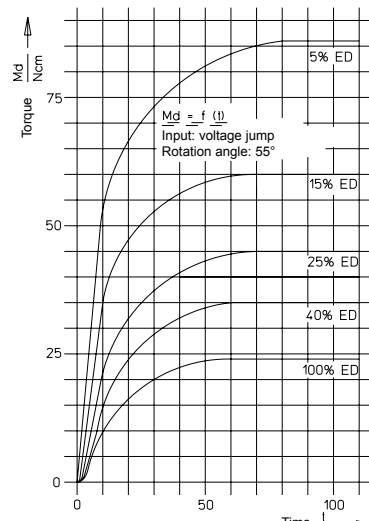
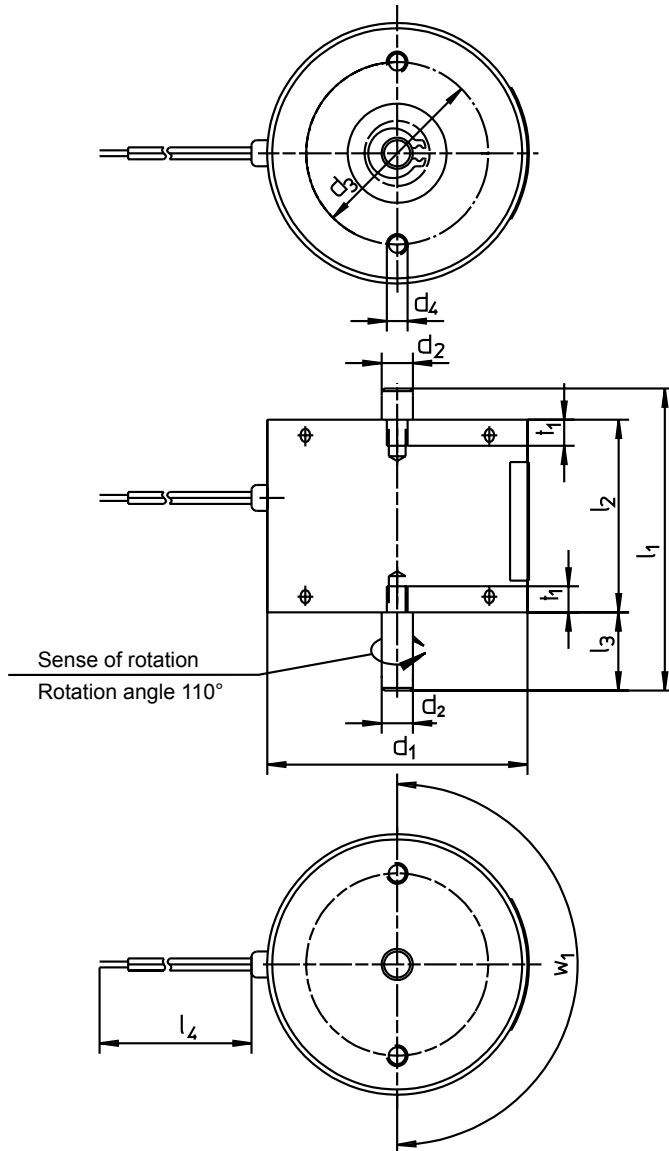

Fig. 14: Characteristics $M_d = f(t)$
Type G DR X 075
MSM-Fo 0804.1677

Dimension tables



G DR ... A01			
Size	035	050	075
Dim.	Dimensions in mm		
d_1	35	50	75
d_2	4 _{h8}	6 _{h8}	10 _{h8}
d_3	25	35	50
d_4	M3	M4	M5
d_5	35	35	35
l_1	46	58	86
l_2	30	37	56
l_3	10	15	20
l_4	100	150	200
¹⁾ t_1	3,5	5	8
w_1	2x180°	2x180°	3x120°

¹⁾ Please do not exceed the thread depth t1 as this may cause a damage of the coil.

MSM-Fo 0804.1710

Fig. 15:
Dimensions
Type G DR X 035 X 20 A01
to type G DR X 075 X 20 A01

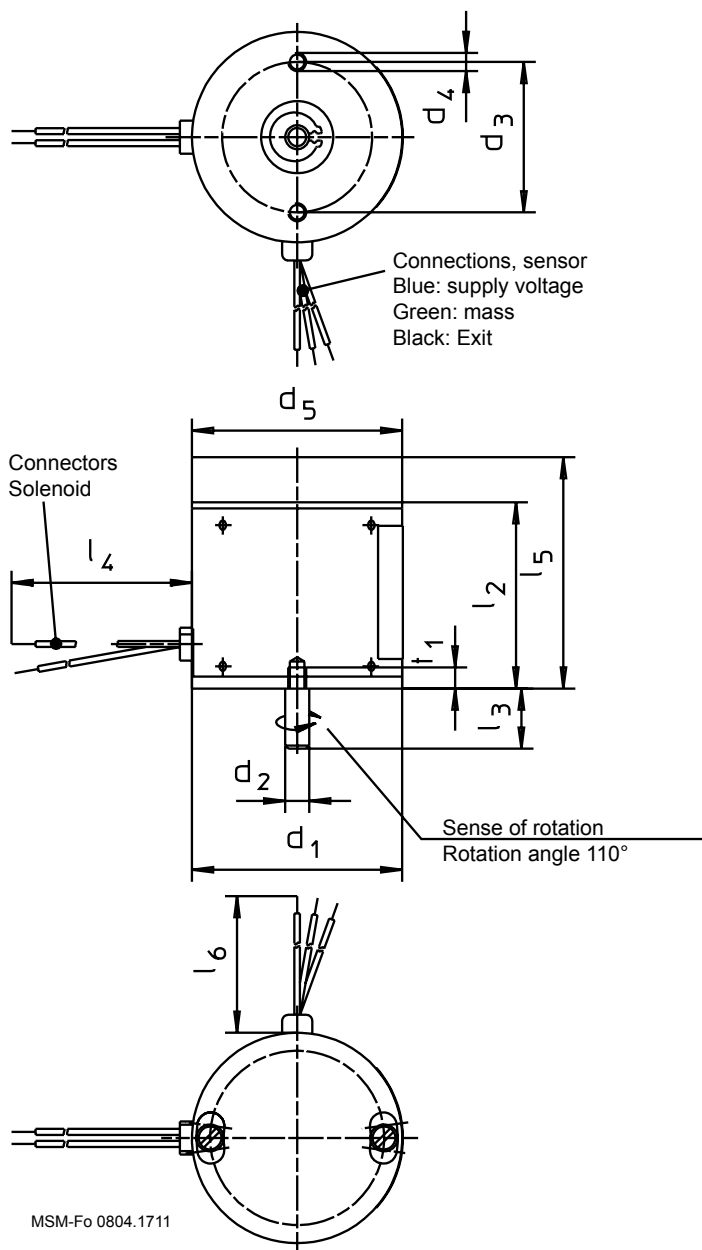

Fig. 16:
 Dimensions
 Type G DR X 035 X 20 A61
 to type G DR X 075 X 20 A61
 With rotation angle position sensor

G DR ... A61			
Size	035	050	075
Dim.	Dimensions in mm		
d_1	35	50	75
d_2	4_{h8}	6_{h8}	10_{h8}
d_3	25	35	50
d_4	M3	M4	M5
d_5	35	35	35
l_2	30	37	56
l_3	10	15	20
l_4	100	150	200
l_5	38,5	45,5	64,5
l_6	200	200	200
$^1)t_1$	3,5	5	8

¹⁾ Please do not exceed the thread depth t_1 as this may cause a damage of the coil.

(missing dimensions see fig. 15)

This part list is a document for technically qualified personnel. This publication is for informational purposes only and must not be considered as mandatory product description, unless this is confirmed expressively.

Please make sure that the described devices are suitable for your application. Please find further information about the duly assembly among others in the -Technical Explanations, the valid DIN VDE0580 as well as in the relevant prescriptions.

Information and remarks concerning European directives can be taken from the correspondent information sheet which is available under Produktinfo.Magnet-Schultz.com.

Note on the RoHS guideline 2002/95/ EC

The devices presented in this document do not fall into the scope of regulation 2002/95/EC („RoHS“) and do not become part of products which fall into the scope according to our state of information. In case of surfaces zinc coating with yellow chromating and zinc iron with black chromating separate agreements are necessary for application according RoHS.



Type code

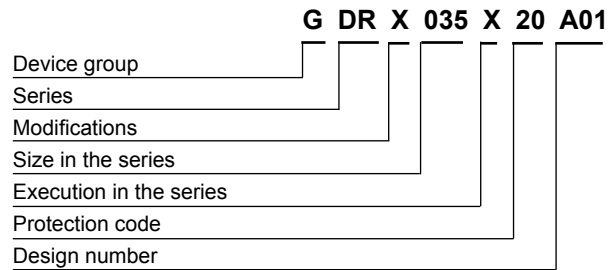

Order example

Type	G DR X 035 X20 A01
Voltage	== 24 V DC
Operating mode	S1 (100 %)

Special designs

Please do not hesitate to ask us for application-oriented problem solutions. In order to find rapidly a reliable solution we need complete details about your application conditions. The details should be specified as precisely as possible in accordance with the relevant -Technical Explanations.

If necessary, please request the support of our corresponding technical office.