

## Highlights

- Multiple sensor design (up to 8 heads for 1 box)
- Plug & Play (automatic head detection from the box)
- High temperature resistance for the head up to 180°C (356°F) without cooling
- Multiple spectral ranges covered by one sensor model
- Extended temperature range for LT head up to 1000°C (1832°F)
- Dedicated 5 µm head for measuring of glass
- Laser sighting for 1M/2M sensing heads
- Spot sizes down to 0.5 mm (0.02 in) with Close Focus Lens
- Fast 10 ms response time
- Industrial rugged head cable (PUR): Silicone and Halogen free, resistant against oil, bases, and acids
- Networkable OEM head model (without a box)
- Intrinsically safe sensing heads with dedicated Ex-power supply

## MI3 Heads

### Datasheet



### Measurement Specifications

<b>Temperature Range</b>	
LTS02, LTS10, LTH10	-40 to 600°C (-40 to 1112°F)
LTS20, LTF, LTH20	0 to 1000°C (32 to 1832°F)
G5	250 to 1650°C (482 to 3002°F)
2M	250 to 1400°C (482 to 2552°F)
1M	500 to 1800°C (932 to 3272°F)
<b>Spectral Response</b>	
LT	8 – 14 µm
G5	5 µm
2M	1.6 µm
1M	1 µm
<b>Optical Resolution<sup>1</sup></b>	
LTS (standard)	2:1, 10:1, 22:1 typ. (21:1 guaranteed)
LTH	10:1, 22:1 typ. (21:1 guaranteed)
LTF (fast)	10:1
G5	10:1
1M, 2M	100:1
<b>Accuracy<sup>2</sup></b>	
LT, G5	± (1% of reading or 1°C) <sup>3,4</sup>
1M, 2M	± (0.5% of reading + 2°C)
<b>Repeatability</b>	
LT, G5	± 0.5% of reading or ± 0.5°C <sup>3</sup>
1M, 2M	± (0.25% of reading + 1°C)
<b>Temperature Coefficient</b>	
LT, G5	± 0.05 K / K or ± 0.05% / K of reading <sup>3</sup>
1M, 2M	± 0.01% / K of reading
<b>Response Time<sup>5</sup></b>	
LTS (standard), LTH	130 ms
LTF (fast)	20 ms
G5	130 ms
1M, 2M	10 ms
<b>Emissivity ε</b>	
	0.100 to 1.100
<b>Transmission</b>	
	0.100 to 1.000
<b>Signal Processing</b>	
	Peak hold, valley hold, adjustable up to 998 s variable averaging filter

<sup>1</sup> 90% energy

<sup>2</sup> at ambient temperature 23°C ± 5°C (73°F ± 9°F), ε = 1.0, and calibration geometry

<sup>3</sup> whichever is greater

<sup>4</sup> ± 2°C (± 4°F) for target temperatures < 20°C (68°F)

<sup>5</sup> 90% value

### General Specifications

<b>Ambient Temperature</b>	
LT, G5	-10 to 120°C (14 to 248°F)
LTH	-10 to 180°C (14 to 356°F)
1M, 2M	0 to 120°C (32 to 248°F)
Laser (1M, 2M)	automatic switch off at 65°C (149°F)
<b>Storage Temperature</b>	
LTH	-20 to 180°C (-4 to 356°F)
all other models	-20 to 120°C (-4 to 248°F)
<b>Environmental Rating</b>	
	IP65 (NEMA-4)
<b>EMC</b>	
	EN 61326-1:2006

### Dimensions

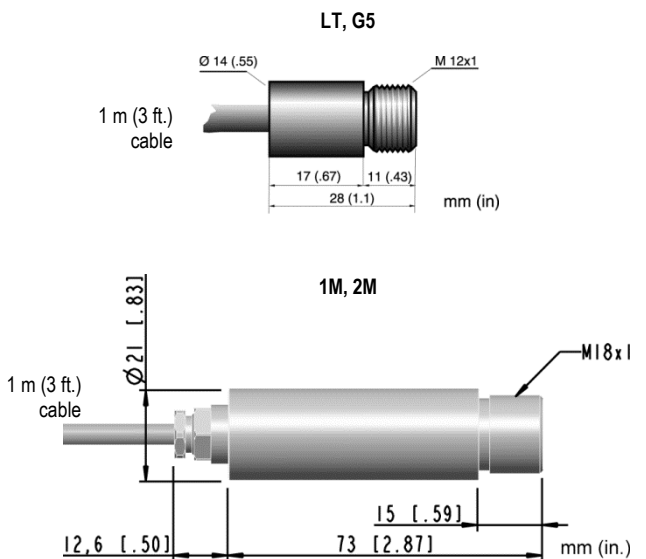

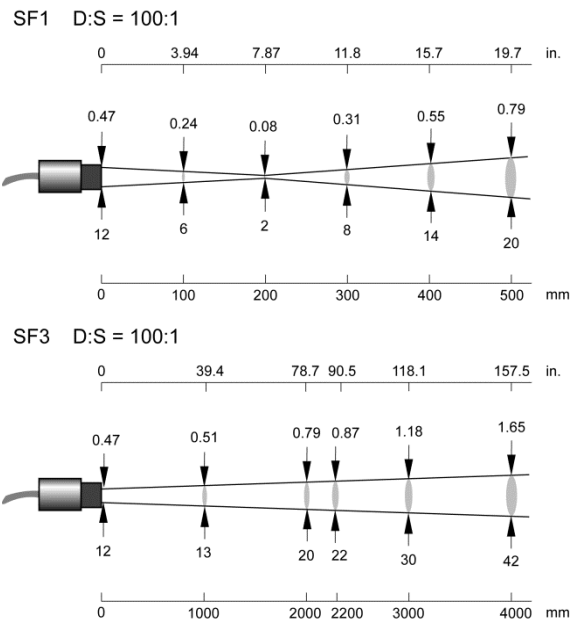
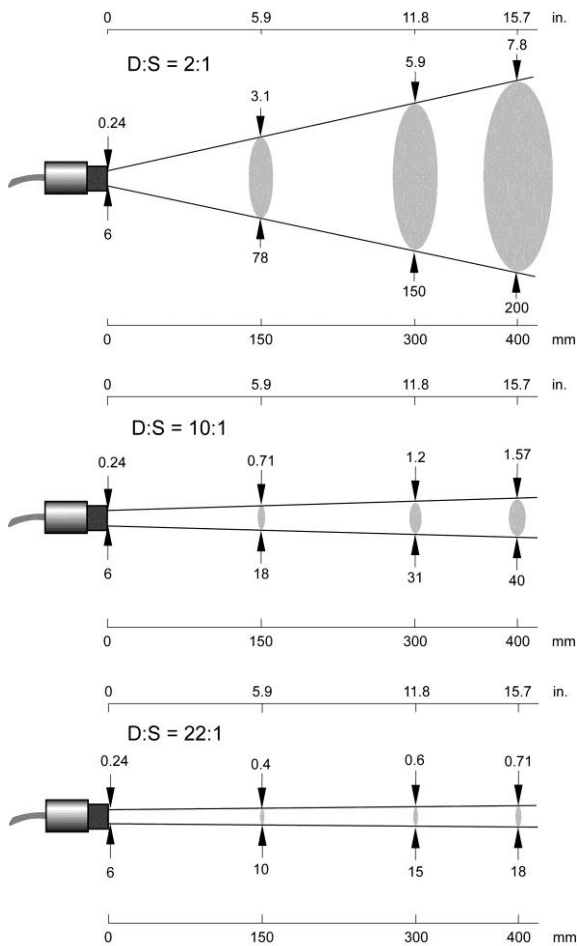

## Optical Specifications (90% energy)





## Intrinsic Safety

Intrinsically safe sensing heads (MI3...IS):

-  II 2G Ex ib IIC T4 Gb (gas)
-  II 2D Ex ib IIIC T135°C Db (dust)

Ex Power supply (MI3ACIS):

-  II (2)G [Ex ib Gb] IIB (gas)
-  II (2)D [Ex ib Db] IIIC (dust)

## Accessories

Accessories include items that may be ordered at any time and added on-site:

- Adjustable Bracket (LT, G5: XXXMIACAB / 1M, 2M: XXXMI3100ADJB)
- Fixed Bracket (LT, G5: XXXMIACFB / 1M, 2M: XXXMI3100FB)
- Isolation Kit for Fixed Bracket (1M, 2M: XXXMI3100ISOKIT)
- Air Purge (LT, G5: XXXMIACAJ / 1M, 2M: XXXMI3100AP)
- Air Cooling Jacket (XXXMIACCJ: 0.8 m/2.6 ft, XXXMIACCJ1: 2.8 m/9.2 ft) for ambient temperatures up to 200°C/392°F (LT, G5 only)
- Close Focus Lens (LT, G5: XXXMI3ACFL)
- Protective Window (LT, G5: XXXMIACPW / 1M, 2M: XXXMI3100PW)

### Air Purge Jacket

for LT, G5 heads  
(XXXMIACAJ)



for 1M, 2M heads  
(XXXMI3100AP)



## Options

Options must be specified at time of order.

- Longer head cable lengths: 3 m, 8 m, 15 m, 30 m (9.8, 26, 49, 98 ft.)
- Water cooled housing (1M, 2M heads)
- Networkable OEM sensing head without the need for a box

### Water Cooled Housing (1M, 2M)



## The Worldwide Leader in Noncontact Temperature Measurement

**Raytek Corporation**  
Worldwide Headquarters  
Santa Cruz, CA USA  
Tel: +1 800 227 8074 (USA and Canada, only)  
+1 831 458 3900  
solutions@raytek.com

**European Headquarters**  
Berlin, Germany  
Tel: +49 30 4 78 00 80  
raytek@raytek.de

**China Headquarters**  
Beijing, China  
Tel: +8610 6438 4691  
info@raytek.com.cn

[www.raytek.com](http://www.raytek.com)



Raytek is an ISO 9001 certified company

© 2015 Raytek Corporation (4106811 Rev. E) 4/2015  
Raytek and the Raytek logo are registered trademarks of Raytek Corporation.  
Specifications subject to change without notice.