

COMELETRIC

Specialized rotary and control switches

MINI MINIATURE
CONTROL SWITCHES AND
DISCREPANCY SWITCHES
FOR MOSAIC TILE SYSTEMS
FRMC 2000 - FRMM 2000

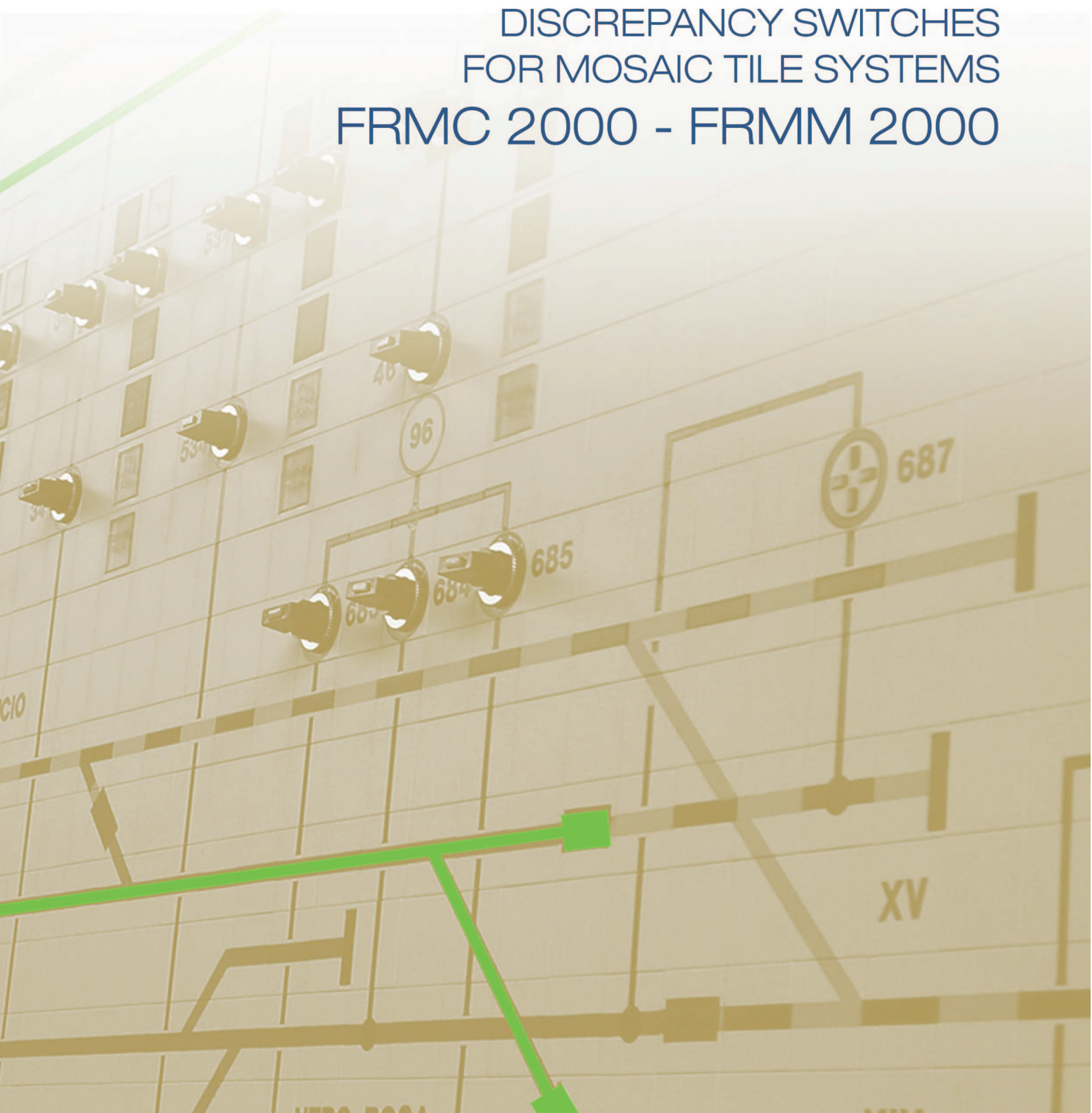

INDEX

INDICE

Control your System.....1

SERIES FRMC 2000 Mini miniature Control Switch.....2
SERIE FRMC 2000 Mini micro Commutatore di comando

SERIES FRMM 2000 Mini miniature Discrepancy Switch.....3
SERIE FRMM 2000 Mini micro Manipolatore comando e segnalazione

Technical data.....4

CONTROL YOUR SYSTEM

The Miniature Control Switches and Miniature Discrepancy Switches "FRMC 2000 - FRMM 2000" are mainly used in auxiliary circuits to connect and disconnect relays, electronically controlled valves, etc... They are particularly suitable for assembly in Mosaic Panels with tiles measuring 24 x 24mm.

I Microcommutatori e Micromanipolatori "FRMC 2000 - FRMM 2000" vengono prevalentemente impiegati in circuiti ausiliari per l'inserzione e disinserzione di relè, elettrovalvole, etc...

Sono particolarmente adatti per il montaggio in Quadri Mosaico a tessere 24 x 24mm.

- * Double bridge rotor contact in phosphor-bronze alloy, knife stationary contacts with wiping self-cleaning effects.
- * Contatto mobile in bronzo fosforoso a doppio ponte, contatti fissi a coltello con effetto strisciante autopulente.

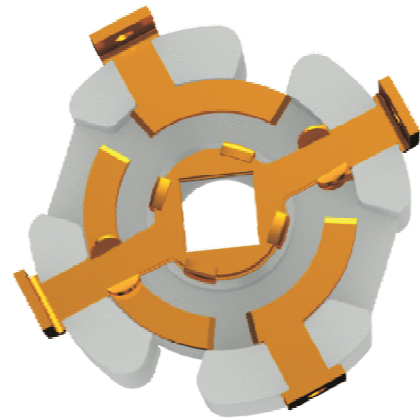

- * Contacts thickly gold-plated.
- * Contatti dorati a forte spessore.

- * Welding type terminals.
- * Terminali a saldare diretti.



- * Main body anodised aluminium.
- * Struttura portante in alluminio anodizzato.

- * Low contact resistance 10mΩ
- * Bassa resistenza di contatto 10mΩ

- * Insulating elements in melamine UL94-VO.
- * Elementi isolanti in melamina UL94-VO.

- * Wide range of electrical diagrams.
- * Numerose possibilità di schemi elettrici.

- * Metal parts zinc or nickel plated.
- * Parti metalliche zincate o nichelate.

- * IP20 protection in conformity with the standard IEC 60529 provided by means of plastic transparent cover.
- * Protezione IP20 in conformità alla norma IEC 60529 grazie ad una cover in plastica trasparente.

Series FRMC 2000

MINI MINIATURE CONTROL SWITCHC

Dimensions

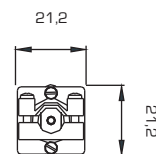
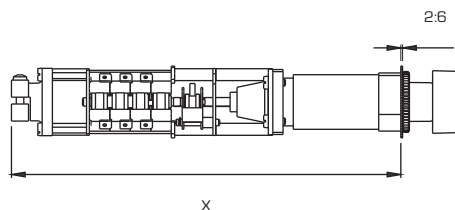
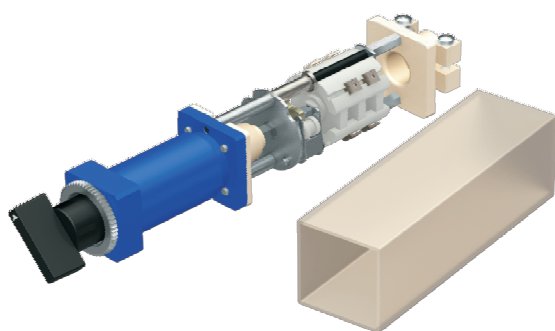

Model : **C201**

Designed to be fitted on mosaic panels with tiles of 24 x 24 mm.
Can have from 2 to 8 positions with notching mechanism from 45° or 90°.
The fitting made from the front of the panel using a threadedring nut.
Up to 8 contact packets can be assembled.

Progettato per essere montato in quadri a mosaico con tessere 24 x 24 mm.
Realizza da 2 a 8 posizioni con scatto 45° o 90°.
Il fissaggio avviene dal fronte mediante ghiera filettata.
Si possono assemblare fino a 8 pacchi di contatti.

Panel Drilling

N° PACKETS N° PACCHI	1	2	3	4	5	6	7	8
X=LENGHT mm LUNGH mm	102	108	114	120	126	132	138	144

Series FRMC 2000

MINI MINIATURE CONTROL SWITCH

Dimensions

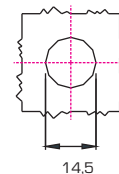
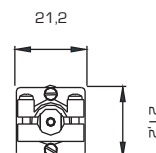
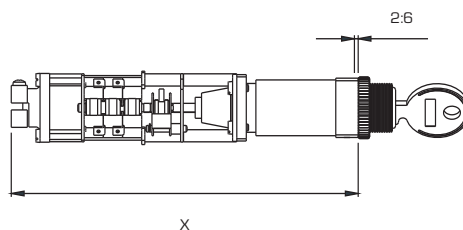
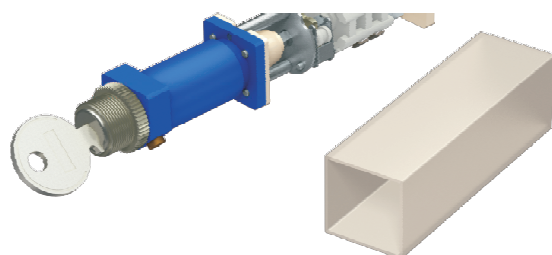

Model : **C202**

Miniature key operated switch for mosaic panels.
Particularly suitable for preventing activation by non authorized staff.
Equipped with RONIS MICRO lock available with all the same numbering, with all different numbering or with numbering differentiated group by group.

Commutatore in miniatura a chiave per quadri a mosaico.
Adatto per evitare l'azionamento da personale non autorizzato.
Dotato di serratura RONIS MICRO è disponibile con cifrature uguali, diverse o diverse a gruppi.

Panel Drilling

N° PACKETS N° PACCHI	1	2	3	4	5	6	7	8
X=LENGHT mm LUNGH mm	102	108	114	120	126	132	138	144

Series FRMM 2000

MINI MINIATURE DISCREPANCY SWITCH

Dimensions

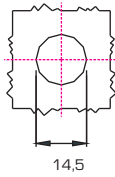
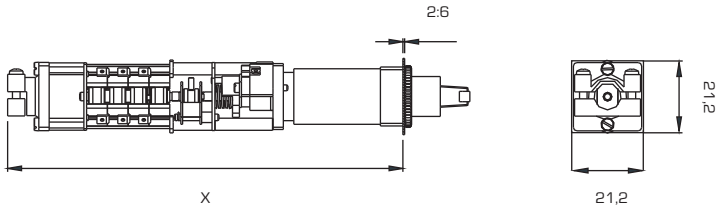

Panel Drilling

N° PACKETS N° PACCHI	1	2	3	4	5	6	7	8
X=LENGHT mm LUNGH mm	102	108	114	120	126	132	138	144

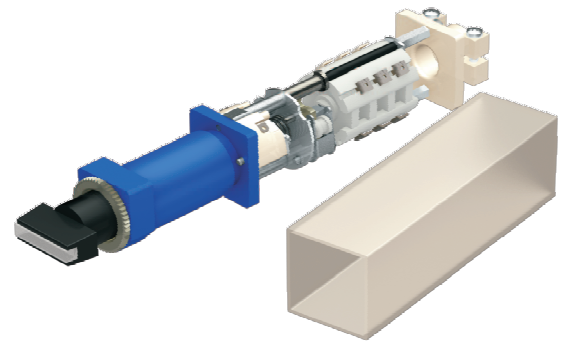

Model : M201

Mini Miniature Discrepancy Switch for assembly in mosaic panels with tiles measuring 24 x 24 mm. The luminous signal is provided by an incandescent bulb or LED with T5,5 connector extractable from the front of the discrepancy switch after the removal of the knob.

Micro manipolatore comando e conferma per quadri a mosaico con tessere 24 x 24 mm. Segnalzione luminosa tramite lampada ad incandescenza o LED con attacco T5,5 estraibile dal fronte del manipolatore previa asportazione della manopola.

Dimensions

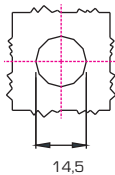
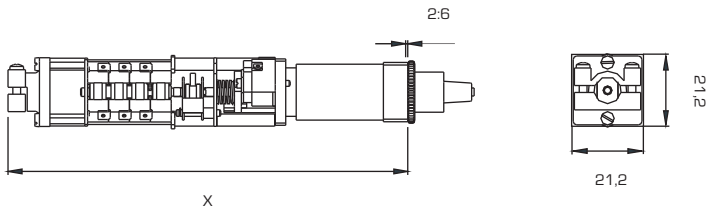

Panel Drilling

N° PACKETS N° PACCHI	1	2	3	4	5	6	7	8
X=LENGHT mm LUNGH mm	108	114	120	126	132	138	144	150

Series FRMM 2000

MINI MINIATURE DISCREPANCY SWITCH

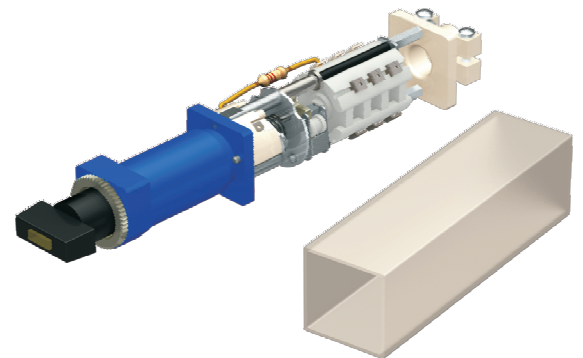

Model : M202

Mini Miniature Discrepancy Switch for assembly in mosaic panels tiles measuring 24 x 24 mm, with gold-plated terminals to be welded. The luminous signals is provided by a rectangular LED 2,5 x 7 mm at 24Vcc available in three colours (yellow, red and green).

Micro manipolatore per montaggio in quadri mosaico con tessere 24 x 24 mm con contatti terminali dorati tipo a saldare. La segnalazione luminosa realizzata mediante LED rettangolare 2,5 x 7 mm a 24Vcc è disponibile in tre colorazioni (giallo, rosso e verde).

TECHNICAL DATA

DATI ELETTRICI

Standard utilization categories
Categorie di Utilizzazione normalizzate

Kind of current Tipo di corrente	Category Categoria	Typical applications Applicazioni tipiche
Alternative current Corrente alternata	AC14	Control of small electromagnetic load with rated power = 72VA Comando di piccoli carichi elettromagnetici con potenza = 72VA
	AC15	Control of electromagnetic load with rated power > 72VA Comando di carichi elettromagnetici con potenza > 72VA
Direct current Corrente continua	DC13	Control of electromagnets Comando di elettromagneti
	DC14	Control of electromagnetic loads having economy resistor in circuit Comando di carichi elettromagnetici aventi resistori economizzatori nel circuito

Utilization category Categoria utilizzazione	NORMAL CONDITIONS CONDIZIONI NORMALI			
	Make Chiusura	Break Interruzione	U/Ue	cos Φ
	I/Ie	I/Ie		
AC14	6	1	1	0.3
AC15	10	1	1	0.3

Utilization category Categoria utilizzazione	ABNORMAL CONDITIONS CONDIZIONI ANOMALE			
	Make Chiusura	Break Interruzione	U/Ue	cos Φ
	I/Ie	I/Ie		
	6	6	1.1	0.7
	10	10	1.1	0.3

Utilization category Categoria utilizzazione	Make Chiusura	Break Interruzione	U/Ue	T _{0.95} [ms]
				6xP
DC13	1	1	1	6xP
DC14	10	1	1	15

Utilization category Categoria utilizzazione	Make Chiusura	Break Interruzione	U/Ue	T _{0.95} [ms]
				6xP
	1.1	1.1	1.1	6xP
	10	10	1.1	15

- I/Ie : Current to be made or broken and Rated operational current ratio.
Rapporto tra la corrente che l'apparecchiatura è in grado di stabilire o interrompere e la corrente d'impiego.
- U/Ue : Voltage before make and Rated operational voltage ratio.
Rapporto tra la tensione prima della chiusura e la tensione d'impiego.
- T_{0.95} : Time to reach 95% of the steady-state current.
Tempo per raggiungere il 95% della corrente di regime.
- P=Ue x Ie: Steady-state power consumption in W.
Potenza assorbita a regime in W.

The value "6xP" result from empirical relationship which is found to represent most d.c. magnetics loads to an upper limit of P =50W, i.e. 6 x P=300 ms. Load having power-consumption greater than 50W are assumed to consist of smaller loads in parallel. Therefore, 300 ms is to be an upper limits irrespective of the power. (REFERENCE STANDARD IEC 60947-5-1 tab. 5).

La relazione matematica "6xP" è valida per tutti carichi induttivi rappresentativi fino ad un massimo di P pari a 50W cioè 6xP =300ms. Si assume che i carichi aventi una potenza assorbita superiore a 50W siano costituiti da piccoli carichi collegati in parallelo, di conseguenza 300ms è il valore massimo a prescindere dalla potenza assorbita. (RIFERIMENTO NORMA IEC 60947-5-1 tab. 5)

RATED ELECTRICAL CHARACTERISTICS

CARATTERISTICHE ELETTRICHE NOMINALI

According to standards
Conformità alle norme

IEC 60947-1 - IEC 60947-1/A1 - IEC 60947-5-1 - IEC 60947-5-1/A1 - EN 60947-1 - EN 60947-1/A1 - EN 60947-5-1 - EN 60947-5-1/A1 - VDE 0660-100 - VDE 0660-200 - 2006/95/EC (Low Voltage Directive) , 2004/108/EC (EMC Directive) , 2011/65/EU (ROHS Directive).

Conventional free air thermal current Corrente convenzionale termica in aria	(I_{th})	8A
Rated insulation voltage Tensione di isolamento nominale :	(U_i)	300V
Rated impulse withstand voltage Tensione di tenuta ad impulso nominale:	(U_{imp})	2,5KV
Frequenza di impiego Frequency:		50/60Hz
Relevant information about the associated Short Circuit Protective Device Dati relativi al dispositivo di protezione contro il corto circuito associabile		
Rated conditional short-circuit current (Max Peak current) Massima Corrente di picco ammissibile		1000A
Rated Maximum Joule integral Integrale di Joule massimo		7KA ² s
Contact Resistance Resistenza di contatto		mΩ 10

MAKING AND BREAKING CAPACITIES POTERI DI CHIUSURA ED INTERRUZIONE

Categoria di utilizzazione Utilization Category	(U_e)	(I_e)
AC 14	230V	4A
AC 15	230V	2,5A
DC13	130V	1A
DC14	110V 130V	1A 0,5A

Tipo di terminale utilizzabile:
Type of connecting terminals



Terminal to be welded



Permissible Wire Gage
Sezione del conduttore

Single - core or stranded wire
Cavo rigido o intrecciato

(mm²)

0,5
AWG25

Flexible wire
Cavo flessibile

(mm²)

0,5
AWG25

ENVIRONMENTAL DATA DATI AMBIENTALI

Temperature range:
Temperatura ambiente:

Operating temperature
Esercizio:

-25°C + 60°C

Storage temperature
Stoccaggio:

-40°C + 80°C