

POSITAPE®
WB100M
Analog Output

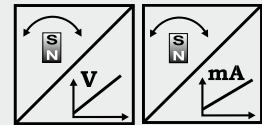

Position sensor with measuring tape

- Measurement range up to 10000 mm
- Protection class IP68/IP69K
- Stainless steel measuring tape
- Analog output



Specifications	Outputs	U2	Voltage 0.5 ... 10 V
		U8	Voltage 0.5 ... 4.5 V
		I1	Current 4 ... 20 mA, 3 wire
	Resolution		<0.05 mm
	Linearity		±0.10 % f. s. (standard); ±0.05 % (optional)
	Sensing device		Magnetic absolute encoder
	Material		Stainless steel and plastic; Tape: stainless steel, 10 mm wide, 0.08 mm thick
	Protection class		IP68/IP69K
	Connection		Cable output, standard length 2 m
	Shock		EN 60068-2-27:1993, 100 g/11 ms, 100 shocks
	Vibration		EN 60068-2-6:1995, 20 g 10 Hz-2 kHz, 10 cycles
	EMC, temperature		Refer to output specification

Order code WB100M



Model name

Measurement range (in mm)

2000 / 3500 / 7500 / 10000

Output

- U2 = 0.5 ... 10 V signal conditioner
- U8 = 0.5 ... 4.5 V signal conditioner
- I1 = 4 ... 20 mA signal conditioner

Signal characteristics

- A = increasing (eg. 4 ... 20 mA)
- D = decreasing (eg. 20 ... 4 mA)

Linearity

- L10 = ±0.10 % (standatd)
- L05 = ±0.05 % (optional)

Connection

KAB2M = cable output, standard length 2 m

Dust wiper

BAB1

Order example: WB100M - 2000 - I1 - A - L10 - KAB2M - BAB1



Position sensor with measuring tape

- Measurement range up to 10000 mm
- Protection class IP68/IP69K
- Stainless steel measuring tape
- Analog output, programmable

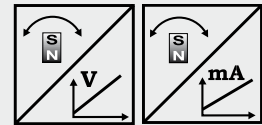

Specifications	Outputs	U2/PMU U8/PMU I1/PMU	Voltage 0.5 ... 10 V, programmable Voltage 0.5 ... 4.5 V, programmable Current 4 ... 20 mA, 3 wire, programmable
	Resolution		<0.05 mm
	Linearity		±0.10 % f. s. (standard); ±0.05 % (optional)
	Sensing device		Magnetic absolute encoder
	Material		Stainless steel and plastic; Tape: stainless steel, 10 mm wide, 0.08 mm thick
	Protection class		IP68/IP69K
	Connection		Cable output, standard length 2 m
	Shock		EN 60068-2-27:1993, 100 g/11 ms, 100 shocks
	Vibration		EN 60068-2-6:1995, 20 g 10 Hz-2 kHz, 10 cycles
	EMC, temperature		Refer to output specification

Order code WB100M

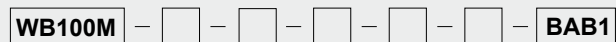

Model name

Measurement range (in mm)

2000 / 3500 / 7500 / 10000

Output

U2/PMU = 0.5 ... 10 V signal conditioner, programmable

U8/PMU = 0.5 ... 4.5 V signal conditioner, programmable

I1/PMU = 4 ... 20 mA signal conditioner, programmable

Signal characteristics

A = increasing (eg. 4 ... 20 mA)

D = decreasing (eg. 20 ... 4 mA)

Linearity

L10 = ±0.10 % (standard)

L05 = ±0.05 % (optional)

Connection

KAB2M = cable output, standard length 2 m

Dust wiper

BAB1

Order example: WB100M - 2000 - U2/PMU - A - L10 - KAB2M - BAB1



Position sensor with measuring tape

- Measurement range up to 10000 mm
- Protection class IP68/IP69K
- Stainless steel measuring tape
- Analog output, redundant

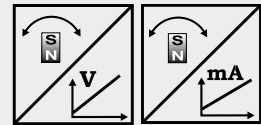

Specifications	Outputs	U2R	Voltage 0.5 ... 10 V, redundant
		U8R	Voltage 0.5 ... 4.5 V, redundant
		I1R	Current 4 ... 20 mA, 3 wire, redundant
	Resolution		<0.05 mm
	Linearity		±0.10 % f. s. (standard); ±0.05 % (optional)
	Sensing device		Magnetic absolute encoder
	Material		Stainless steel and plastic; Tape: stainless steel, 10 mm wide, 0.08 mm thick
	Protection class		IP68/IP69K
	Connection		Cable output, standard length 2 m
	Shock		EN 60068-2-27:1993, 100 g/11 ms, 100 shocks
Vibration		EN 60068-2-6:1995, 20 g 10 Hz-2 kHz, 10 cycles	
EMC, temperature		Refer to output specification	

Order code WB100M



Model name

Measurement range (in mm)

2000 / 3500 / 7500 / 10000

Output

U2R = 0.5 ... 10 V signal conditioner, redundant

U8R = 0.5 ... 4.5 V signal conditioner, redundant

I1R = 4 ... 20 mA signal conditioner, redundant

Signal characteristics

A/A = Output 1 increasing, output 2 increasing

A/D = Output 1 increasing, output 2 decreasing

D/D = Output 1 decreasing, output 2 decreasing

Linearity

L10 = ±0.10 % (standard)

L05 = ±0.05 % (optional)

Connection

KAB2M = cable output, standard length 2 m

Dust wiper

BAB1

Order example: WB100M - 2000 - I1R - A/D - L10 - KAB2M - BAB1

POSITAPE®
WB100M
Digital output SSI



Position sensor with measuring tape

- Measurement range up to 10000 mm
- Protection class IP68/IP69K
- Stainless steel measuring tape
- Digital output SSI

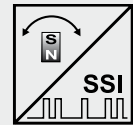

Specifications		
Output	Synchronous serial interface (SSI)	
Resolution	0.05 mm	
Linearity	±0.10 % f. s. (standard); ±0.05 % (optional)	
Sensing device	Magnetic absolute encoder	
Material	Stainless steel and plastic; Tape: stainless steel, 10 mm wide, 0.08 mm thick	
Protection class	IP68/IP69K	
Connection	Cable output, standard length 2 m	
Shock	EN 60068-2-27:1993, 100 g/11 ms, 100 shocks	
Vibration	EN 60068-2-6:1995, 20 g 10 Hz-2 kHz, 10 cycles	
EMC, temperature	Refer to output specification	

Order code WB100M

WB100M - [] - [] - [] - [] - [] - [] - BAB1

Model name

Measurement range (in mm)

2000 / 3500 / 7500 / 10000

Resolution (in µm)

50 (other resolutions on demand)

Output

MSSI = SSI synchronous serial interface

Linearity

L10 = ±0.10% (standard)

L05 = ±0.05% (optional)

Connection

KAB2M = cable output, standard length 2 m

Dust wiper

BAB1

Order example: WB100M - 2000 - 50 - MSSI - L10 - KAB2M - BAB1



Position sensor with measuring tape

- Measurement range up to 10000 mm
- Protection class IP68/IP69K
- Stainless steel measuring tape
- Digital output CANopen or CAN SAE J1939
- Optional redundant CAN Bus (on demand)

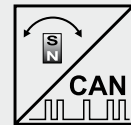

Specifications	Output	CANopen or CAN SAE J1939
	Resolution	setting via CAN Bus
	Linearity	±0.10 % f. s. (standard); ±0.05 % (optional)
	Sensing device	Magnetic absolute encoder
	Material	Stainless steel and plastic; Tape: stainless steel, 10 mm wide, 0.08 mm thick
	Protection class	IP68/IP69K
	Connection	Cable output, standard length 2 m
	Shock	EN 60068-2-27:1993, 100 g/11 ms, 100 shocks
	Vibration	EN 60068-2-6:1995, 20 g 10 Hz-2 kHz, 10 cycles
	EMC, temperature	Refer to output specification

Bestellcode WB100M



Model name

Measurement range (in mm)

2000 / 3500 / 7500 / 10000

Output

MCANOP = CANopen
MCANJ1939 = CAN SAE J1939

Linearity

L10 = 0.10% (standard)
L05 = 0.05% (optional)

Connection

KAB2M = cable output, standard length 2 m

Dust wiper

BAB1

Order example: WB100M - 2000 - MCANOP - L10 - KAB2M - BAB1

Dimensions
WB100M-2000

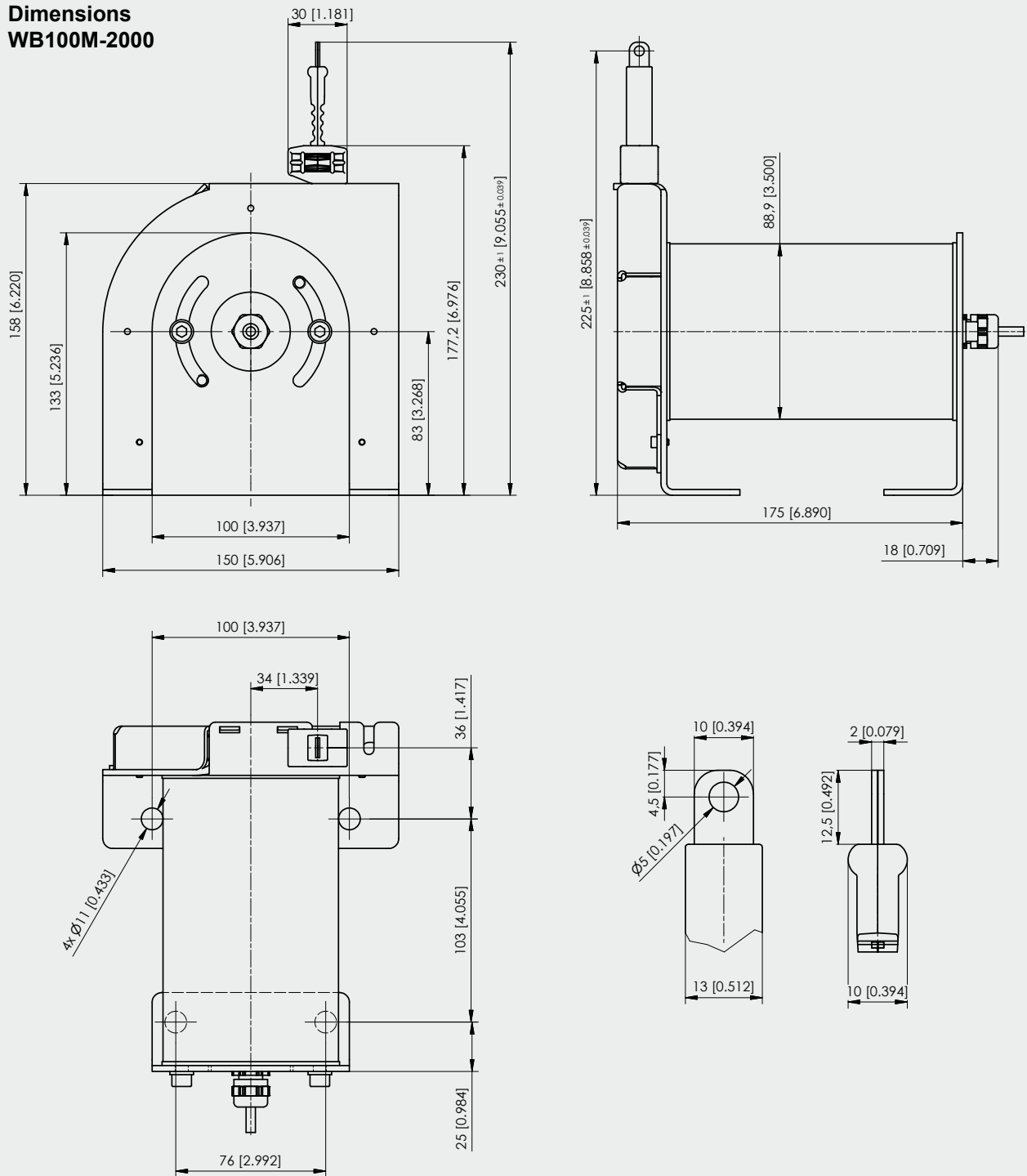

Dimensions in mm [inch]

Dimensions informative only.
For guaranteed dimensions consult factory.

Dimensions
WB100M-3500

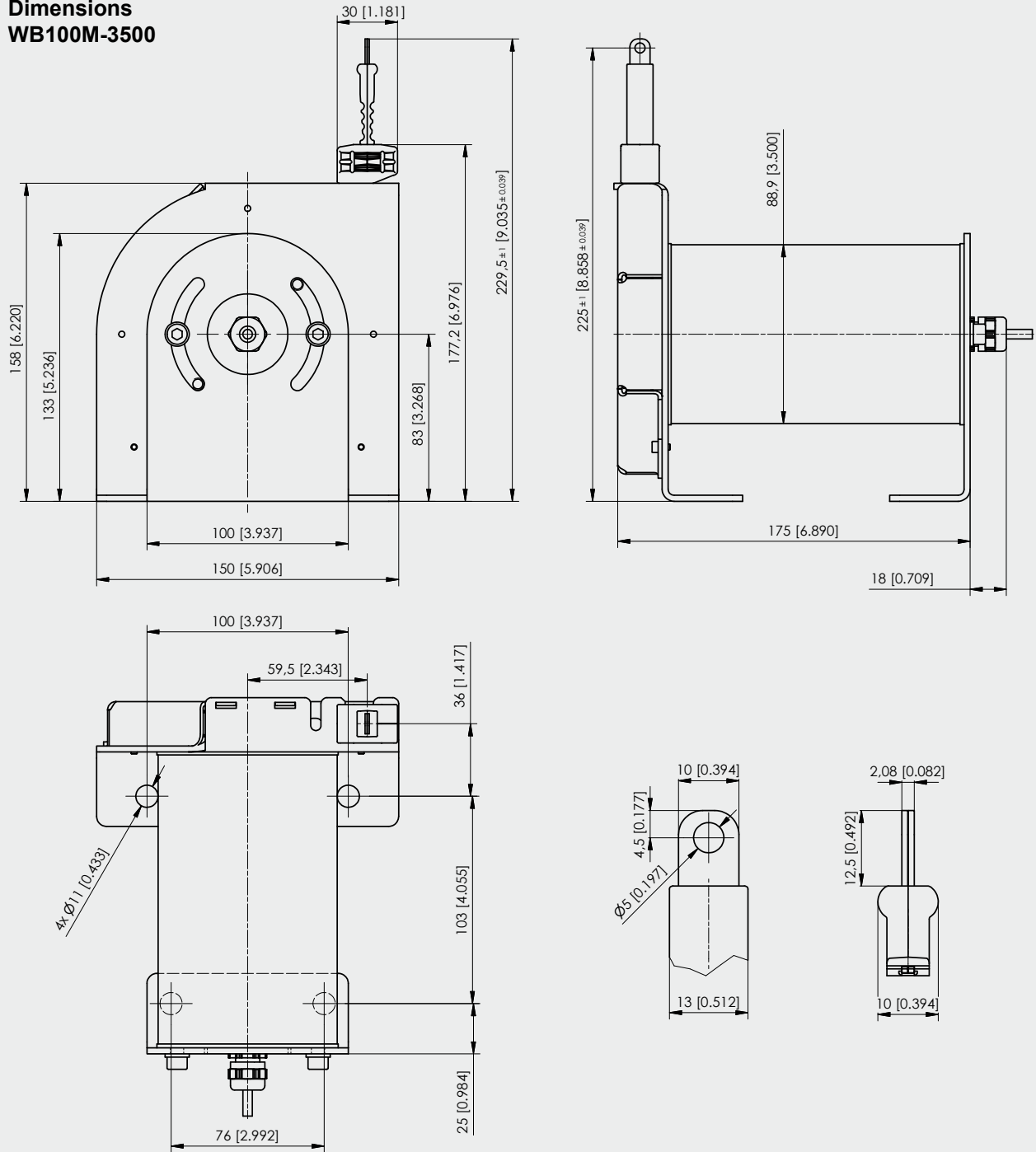

Dimensions in mm [inch]

Dimensions informative only.
For guaranteed dimensions consult factory.

Dimensions
WB100M-7500

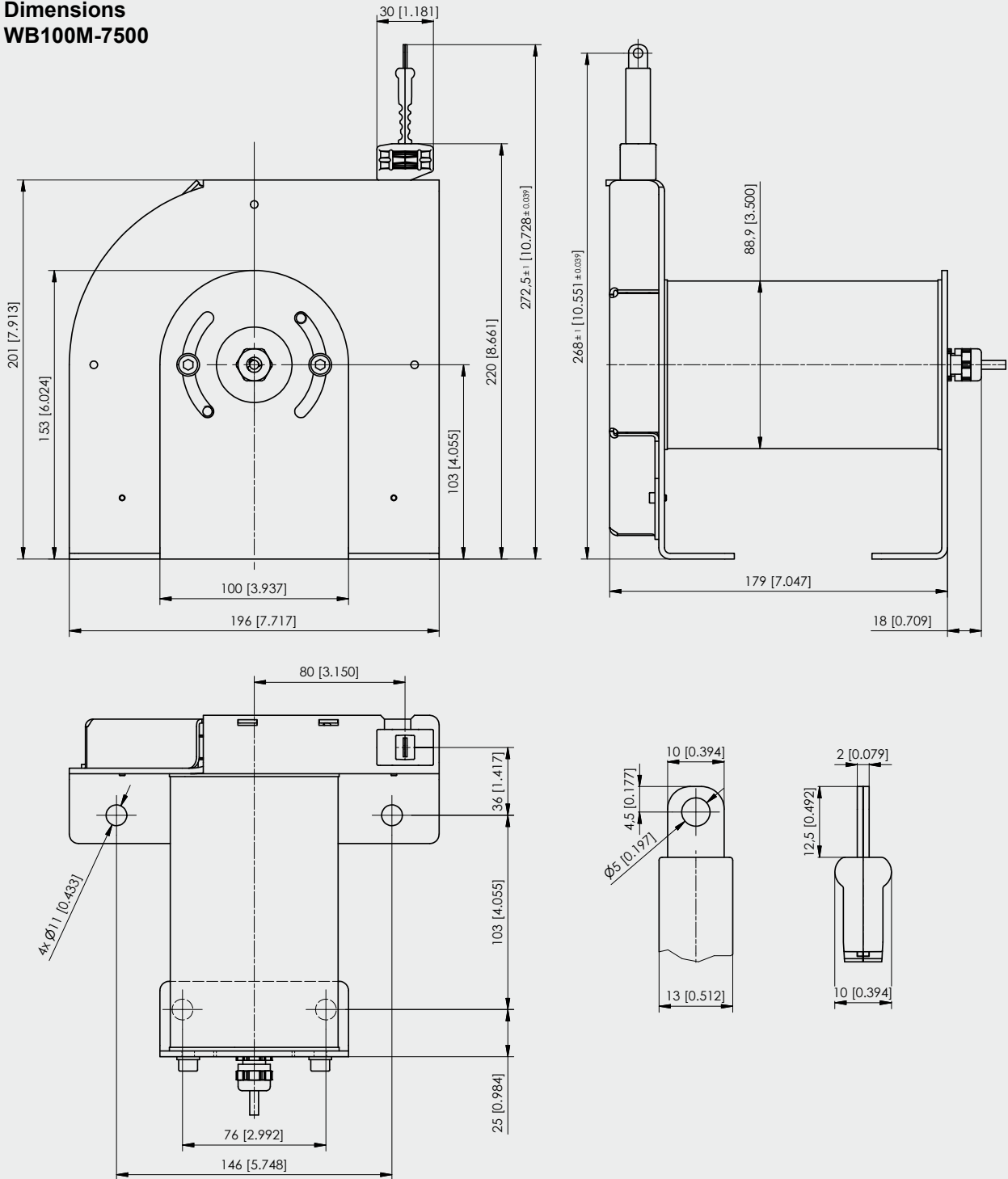

Dimensions in mm [inch]

Dimensions informative only.
For guaranteed dimensions consult factory.

Dimensions
WB100M-10000

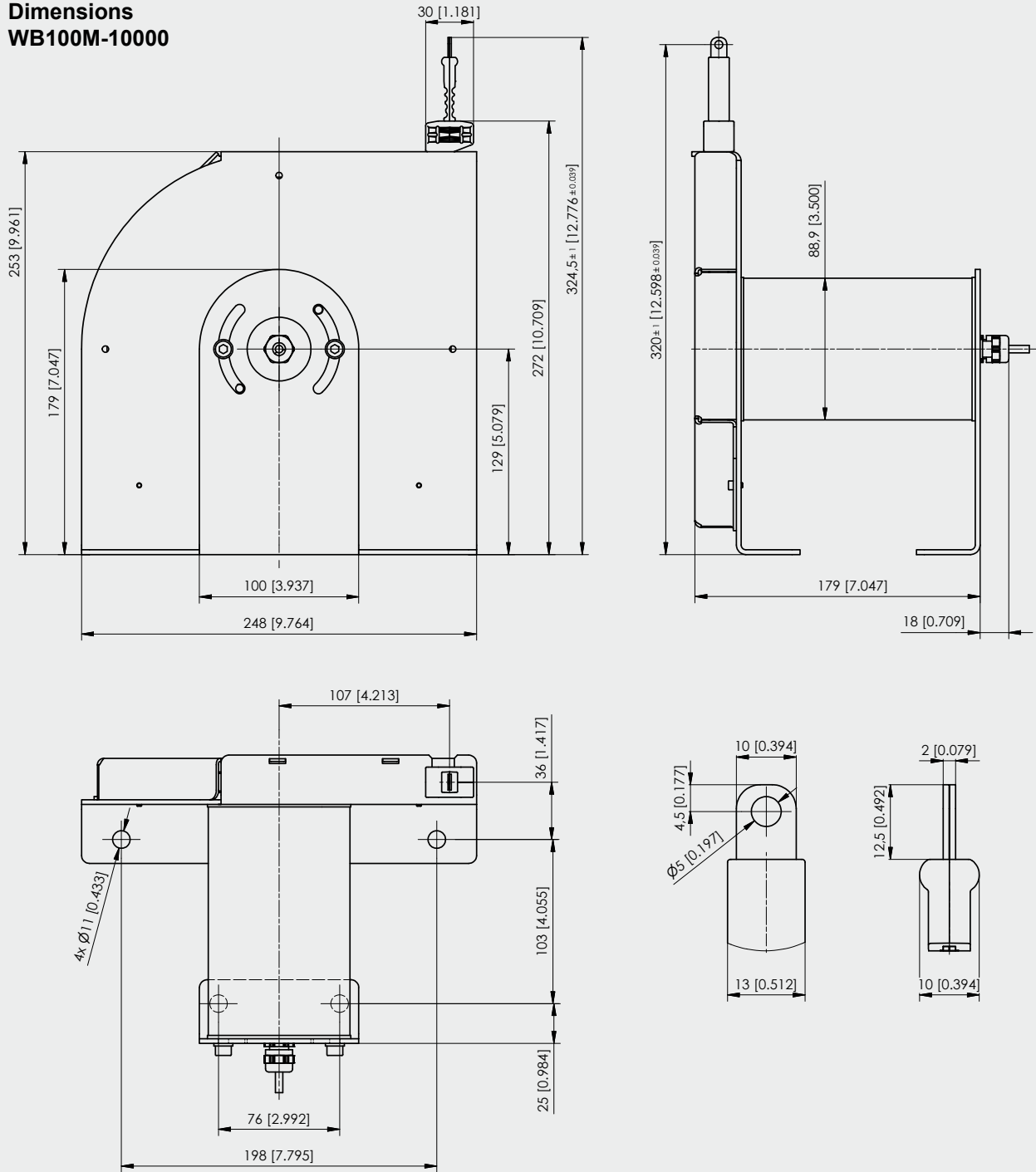

Dimensions in mm [inch]

Dimensions informative only.
For guaranteed dimensions consult factory.

POSITAPE®

U2, U8 and I1

Analog output

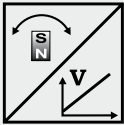

U2 Voltage output 0.5 ... 10 V 	Excitation voltage	10 ... 36 V DC
	Excitation current	typ. 20 mA at 24 V DC typ. 20 mA at 24 V DC max. 60 mA
	Output voltage	0,5 ... 10 V DC
	Output current	2 mA max.
	Measuring rate	1 kHz standard
	Stability (temperature)	$\pm 50 \times 10^{-6}/^{\circ}\text{C}$ f.s. (typ.)
	Protection	Reverse polarity, short circuit
	Operating temperature	-40 ... +85 °C
	EMC	EN61326-1:2006

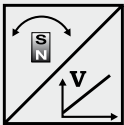
U8 Voltage output 0.5 ... 4.5 V 	Excitation voltage	10 ... 36 V DC
	Excitation current	typ. 17 mA at 24 V DC typ. 32mA at 12 V DC max. 60 mA
	Output voltage	0,5 ... 4,5 V DC
	Output current	2 mA max.
	Measuring rate	1 kHz standard
	Stability (temperature)	$\pm 50 \times 10^{-6}/^{\circ}\text{C}$ f.s. (typ.)
	Protection	Reverse polarity, short circuit
	Operating temperature	-40 ... +85 °C
	EMC	EN61326-1:2006

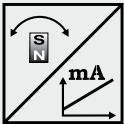
I1 Current output 4 ... 20 mA, 3 wire 	Excitation voltage	10 ... 36 V DC
	Excitation current	typ. 36 mA at 24 V DC typ. 70 mA at 12 V DC max. 100 mA
	Load R_L	500 Ω max.
	Output current	4 ... 20 mA
	Measuring rate	1 kHz standard
	Stability (temperature)	$\pm 50 \times 10^{-6}/^{\circ}\text{C}$ f.s. (typ.)
	Protection	Reverse polarity, short circuit
	Operating temperature	-40 ... +85 °C
	EMC	EN61326-1:2006

Output signals

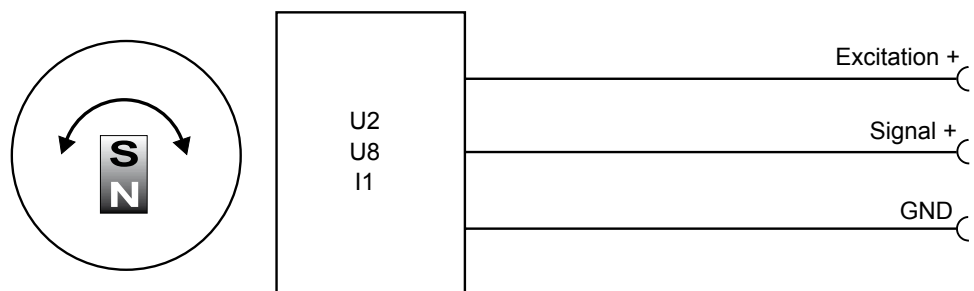

Signal wiring/ connection	Output signal	Connector pin	Cable wire color
	Excitation +	1	brown
	Signal	2	white
	GND	3	blue
	Do not connect!	4	black
	Do not connect!	5	(grey)

View to sensor
connector

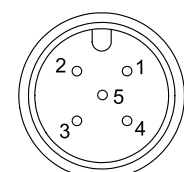

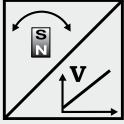
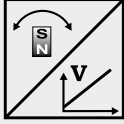
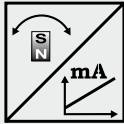
<p>U2/PMU Voltage output 0.5 ... 10 V</p> 	Excitation voltage	10 ... 36 V DC
	Excitation current	typ. 20 mA at 24 V DC, typ. 38 mA at 12 V DC max. 60 mA
	Output voltage	0,5 ... 10 V DC
	Output current	2 mA max.
	Measuring rate	1 kHz standard
	Stability (temperature)	±50 x 10 ⁻⁶ /°C f.s. (typ.)
	Protection	Reverse polarity, short circuit
	Operating temperature	-40 ... +85 °C
	EMC	EN61326-1:2006
	<p>U8/PMU Voltage output 0.5 ... 4.5 V</p> 	Excitation voltage
Excitation current		typ. 17 mA at 24 V DC, typ. 32 mA at 12 V DC max. 60 mA
Output voltage		0,5 ... 4,5 V DC
Output current		2 mA max.
Measuring rate		1 kHz standard
Stability (temperature)		±50 x 10 ⁻⁶ /°C f.s. (typ.)
Protection		Reverse polarity, short circuit
Operating temperature		-40 ... +85 °C
EMC		EN61326-1:2006
<p>I1/PMU Current output 4 ... 20 mA, 3 wire</p> 		Excitation voltage
	Excitation current	typ. 36 mA at 24 V DC, typ. 70 mA at 12 V DC max. 100 mA
	Load R _L	500 Ω max.
	Output current	4 ... 20 mA
	Measuring rate	1 kHz standard
	Stability (temperature)	±50 x 10 ⁻⁶ /°C f.s. (typ.)
	Protection	Reverse polarity, short circuit
	Operating temperature	-40 ... +85 °C
	EMC	EN61326-1:2006

Output signals

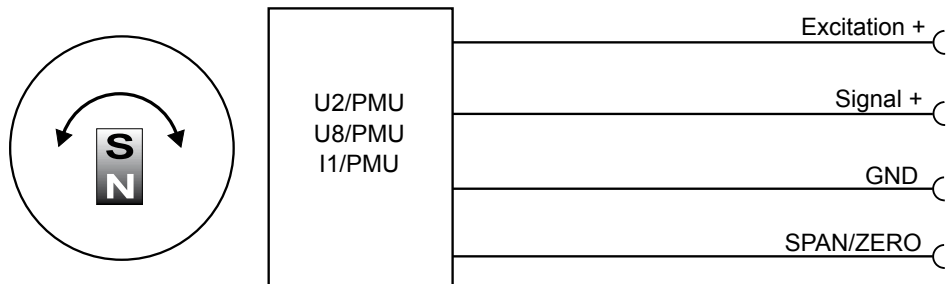

Signal wiring/ connection	Signal	Connector pin	Cable wire color
	Excitation +	1	brown
	Signal	2	white
	GND	3	blue
	Do not connect!	4	black
	SPAN/ZERO	5	grey

View to sensor connector

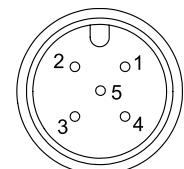

Option -PMU

Programming of the start and end value by the customer

Teach-In of start and end value for the options U2/PMU, I1/PMU, U8/PMU is provided by a binary signal SPAN/ZERO. At the start position connect signal SPAN/ZERO for a period of 2 ... 3 seconds to GND via push button. At the end position connect signal SPAN/ZERO for a period of 5 ... 6 seconds to GND via a push button. The teachd positions will be stored non-volatile.

To reset the sensor to factory default signal ZERO/END must be connected to ground while powering up the sensor for 2 ... 3 seconds.

U2R Voltage output 0.5 ... 10 V 	Excitation voltage	10 ... 36 V DC
	Excitation current	typ. 22 mA at 24 V DC typ. 43mA at 12 V DC max. 60 mA per channel
	Output voltage	0,5 ... 10 V DC
	Output current	2 mA max.
	Measuring rate	1 kHz standard
	Stability (temperature)	$\pm 50 \times 10^{-6}/^{\circ}\text{C}$ f.s. (typ.)
	Protection	Reverse polarity, short circuit
	Operating temperature	-40 ... +85 °C
	EMC	EN61326-1:2006

U8R Voltage output 0.5 ... 4.5 V 	Excitation voltage	10 ... 36 V DC
	Excitation current	typ. 20mA at 24 V DC typ. 38mA at 12 V DC max. 60 mA per channel
	Output voltage	0,5 ... 4,5 V DC
	Output current	2 mA max.
	Measuring rate	1 kHz standard
	Stability (temperature)	$\pm 50 \times 10^{-6}/^{\circ}\text{C}$ f.s. (typ.)
	Protection	Reverse polarity, short circuit
	Operating temperature	-40 ... +85 °C
	EMC	EN61326-1:2006

I1R Current output 4 ... 20 mA, 3 wire 	Excitation voltage	10 ... 36 V DC
	Excitation current	typ. 39 mA at 24 V DC typ. 76 mA at 12 V DC max. 100 mA per channel
	Load R_L	500 Ω max.
	Output current	4 ... 20 mA
	Measuring rate	1 kHz standard
	Stability (temperature)	$\pm 50 \times 10^{-6}/^{\circ}\text{C}$ f.s. (typ.)
	Protection	Reverse polarity, short circuit
	Operating temperature	-40 ... +85 °C
	EMC	EN61326-1:2006

Output signals

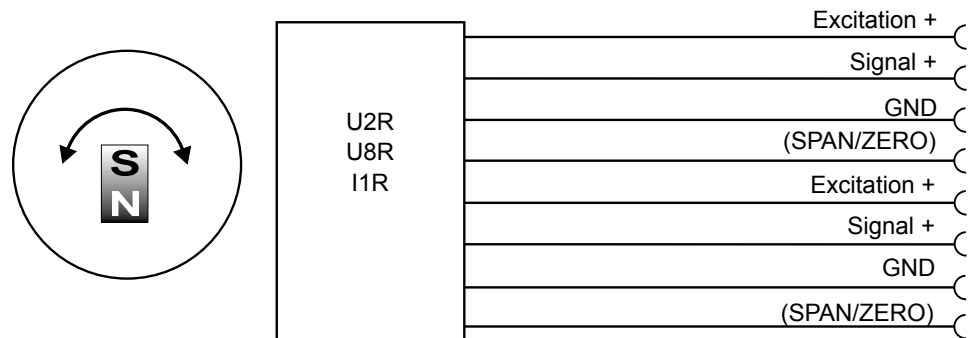

Signal wiring/ connection	Channel	Signal	Connector Pin	Cable wire color
	1	Excitation +	1	white
	1	Signal	2	brown
	1	GND	3	green
	1	SPAN/ZERO (Option PMU)	4	yellow
	2	Excitation +	5	grey
	2	Signal	6	pink
	2	GND	7	blue
	2	SPAN/ZERO (Option PMU)	8	red

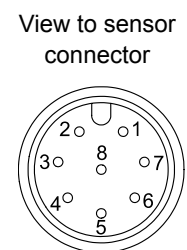

MSSI Synchronous serial SSI 	Interface	EIA RS-422
	Excitation voltage	8 ... 36 V DC
	Excitation current	typ. 19 mA at 24 V DC typ. 35 mA at 12 V DC max. 80 mA
	Clock frequency	100 kHz ... 500 kHz
	Code	Gray-Code, continuous progression
	Delay between pulse trains	20 µs min.
	Stability (temperature)	$\pm 50 \times 10^{-6} / ^\circ\text{C}$ f.s. (typ.)
	Operating temperature	-40 ... +85 °C
	Protection	Short circuit
	EMC	EN61326-1:2006

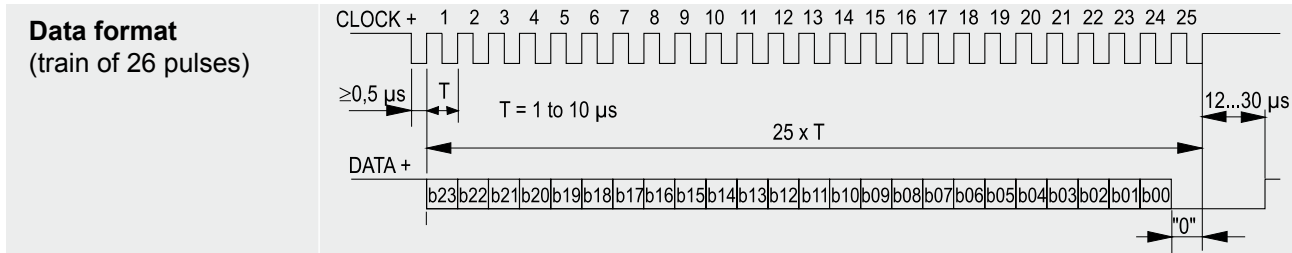

Recommended processing circuit

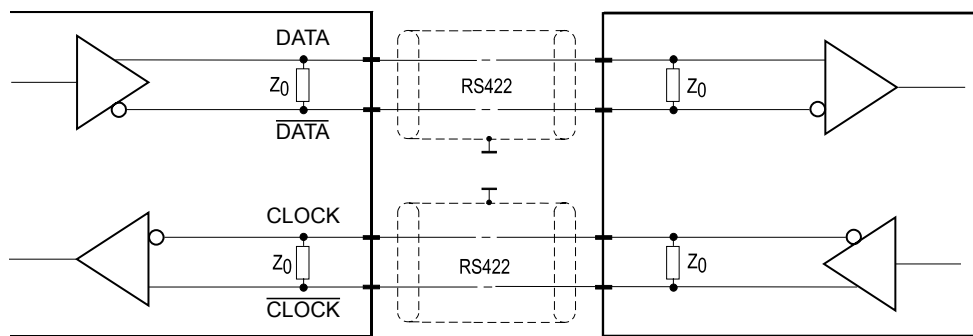

Transmission rate	Cable length	Baud rate
	50 m	100-400 kHz
100 m	100-300 kHz	

Note:
Extension of the cable length will reduce the maximum transmission rate.

Signal wiring/ Connection	Signal	Connector Pin	Cable wire color
	Excitation +	1	white
	Excitation GND	2	brown
	CLOCK	3	green
	$\overline{\text{CLOCK}}$	4	yellow
	DATA	5	grey
	$\overline{\text{DATA}}$	6	pink
	-	7	blu
	-	8	red

View to sensor connector

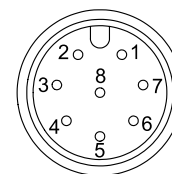

MCANOP
CANopen



Communication profile	CANopen CiA 301 V 4.02, Slave
Encoder profile	Encoder CiA 406 V 3.2
Error Control	Node Guarding, Heartbeat, Emergency Message
Node ID	Adjustable via LSS; default: 127
PDO	3 TxPDO, 0 RxPDO, no linking, static mapping
PDO Modes	Event-/Time triggered, Remote-request, Sync cyclic/acyclic
SDO	1 server, 0 client
CAM	2 cams
Certified	Yes
Transmission rates	50 kbit to 1 Mbit, adjustable via LSS; default: 125 kbit
Bus connection	M12 connector, 5 pins
Integrated bus terminating resistor	No
Bus, galvanic isolated	No

Specifications

Excitation voltage	8 ... 36 V DC
Excitation current	Typ. 20/40 mA for 24/12 V, max. 100 mA
Measuring rate	1 kHz (asynchronous)
Stability (temperature)	$\pm 50 \times 10^{-6}$ / °C f.s.
Repeatability	1 LSB
Operating temperature	-40 ... +85 °C
Protection	Reverse polarity, short circuit
Dielectric strength	1 kV (V AC, 50 Hz, 1 min.)
EMC	According to EN 61326-1:2006

Signal wiring / connection

Signal	Connector pin
Shield	1
Excitation +	2
GND	3
CAN-H	4
CAN-L	5

View to sensor connector

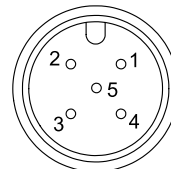

MCANJ1939 CAN SAE J1939 	CAN specification	ISO 11898, Basic and Full CAN 2.0 B
	Transceiver	24V-compliant, not isolated
	Communication profile	SAE J1939
	Baud rate	250 kbit/s
	Internal termination resistor	120 Ω
	Address	Default 247d, configurable

NAME Fields	Arbitrary address capable	1	Yes
	Industry group	0	Global
	Vehicle system	7Fh (127d)	Non specific
	Vehicle system instance	0	
	Function	FFh (255d)	Non specific
	Function instance	0	
	ECU instance	0	
	Manufacturer	145h (325d)	Manufacturer ID
	Identity number	0nnn	Serial number 21 bit

Parameter Group Numbers (PGN)	Configuration data	PGN EF00h	Proprietary-A (PDU1 peer-to-peer)
	Process data	PGN FFnnh	Proprietary-B (PDU2 broadcast); nn Group Extension (PS) configurable

Specifications	Excitation voltage	8 ... 36 V DC
	Excitation current	Typ. 20/40 mA for 24/12 V, max. 100 mA
	Measuring rate	1 kHz (asynchronous)
	Stability (temperature)	±50 x 10 ⁻⁶ / °C f.s.
	Repeatability	1 LSB
	Operating temperature	-40 ... +85 °C
	Protection	Reverse polarity, short circuit
	Dielectric strength	1 kV (V AC, 50 Hz, 1 min.)
	EMC	EN 61326-1:2006

Signal wiring / connection	Signal name	Connector pin no.
	Shield	1
	Excitation +	2
	GND	3
	CAN-H	4
	CAN-L	5

View to sensor connector

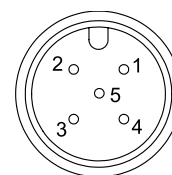

WBR1

