

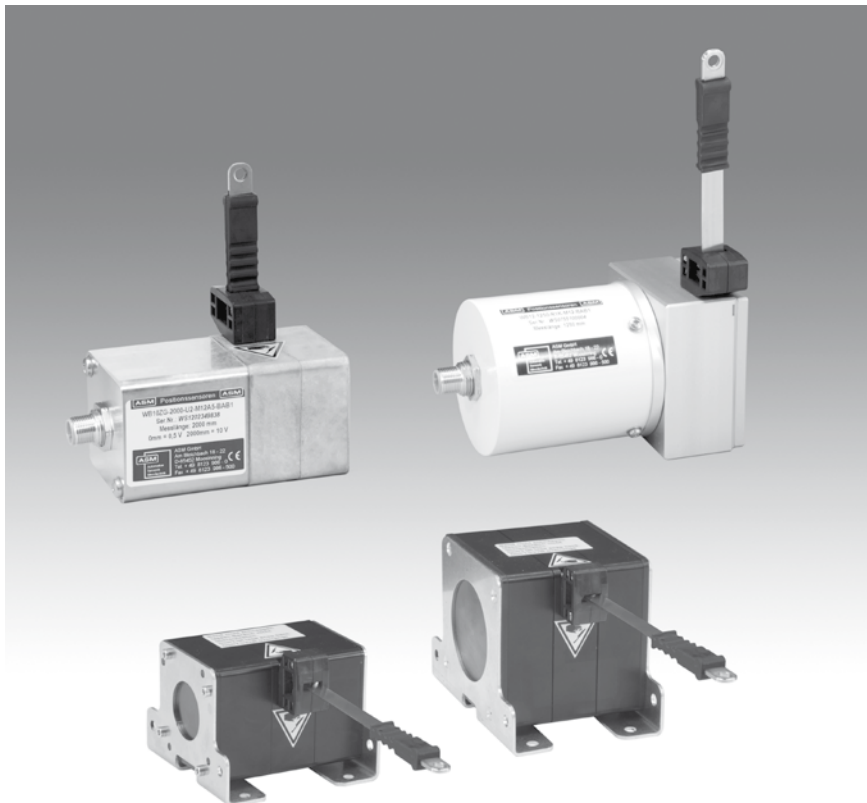

POSITAPE®
Tape Position Sensors
WB Series
Installation and operation manual



Please read carefully before installation and operation!

Contents	Safety instructions	3
	Product description	
	Operating principle	5
	Measurement signal and range	5
	Delivery / shipment	6
	Installation	
	Precautions	6
	Installation position	7
	Fitting the sensor	7
	Calibration (ISO9001)	8
	Electromagnetic compatibility (EMC)	8
	Repair and disposal	8
	Appendix	
	Output specifications	9
	Reliability Characteristics	21
	Declaration of conformity	22

**Safety
instructions**

Do not use WB® Sensors in safety critical applications where malfunction or total failure of the sensor may cause danger for man or machine.

For safety related applications additional mechanisms (devices) are necessary to maintain safety and to avoid damage.

Any alteration, reconstruction or extension of the sensor is not allowed.

Disregard of this advice releases the manufacturer from product liability.

Sensor must be operated only within values specified in the catalog.

Connection to power supply must be performed in accordance with safety instructions for electrical facilities and performed only by trained staff.



Safety
instructions
(continuation)

Do not open sensor

- Release of spring under tension can result in injury!

Do not snap tape

- Uncontrolled tape or metal tape retraction can break off tape fixing. Broken fixing and tape can result in injury. Also sensor will be damaged!

Do not travel over range

- Uncontrolled tape retraction can result in injury. Also sensor will be damaged!

Special attention during mounting and operation of metal tape sensors

- Risk of injury by the metal tape. The metal tape must be installed in such a way that a contact with the tape is impossible!

Sensors without cover / housing (OEM sensors)

- Risk of injury by moving parts. Mounting and operation of the sensor only with appropriate safety equipment that an injury is impossible!

Do not exceed maximum operating voltage listed in the catalog

- Risk of injury. Sensor will be damaged!

Avoid shocks to sensor case

- Sensor may be damaged!

Product Description

The purpose of position sensors is to transform position of a linear and guided movement into an electrical signal. Specifications of measuring range, environment, handling and connections as specified in the catalog, must be followed.

The catalog is part of this instruction manual. If the catalog is not available it may be requested by stating the respective model number.

The Operating Principle

Linear motion of the measuring tape is converted into rotation by means of a precision drum. A spring motor provides torque for the tape retraction. Tape extraction or retraction is transformed into an electrical signal. Depending on application different sensing elements are used. Optional: Subsequent signal conditioners convert the signal of the sensing element into voltage, current, or digital pulses suitable for standard interfaces.

Measurement Signal and Range

<p>Measurement signal: Analog, not adjusted Potentiometer Sensitivity not adjustable</p>	<p>Resistance range is used from about 3% to 98%. 0% or 100% are not possible. Individual sensitivity is specified on the label.</p>
<p>Analog, adjusted Integrated signal conditioner Sensitivity adjusted</p>	<p>Measuring range corresponds to the electrical measuring range (e.g. 4...20 mA).</p>
<p>Digital incremental Incremental encoder Sensitivity not adjustable</p>	<p>Individual sensitivity is specified on label in pulses or increments per millimeter.</p>

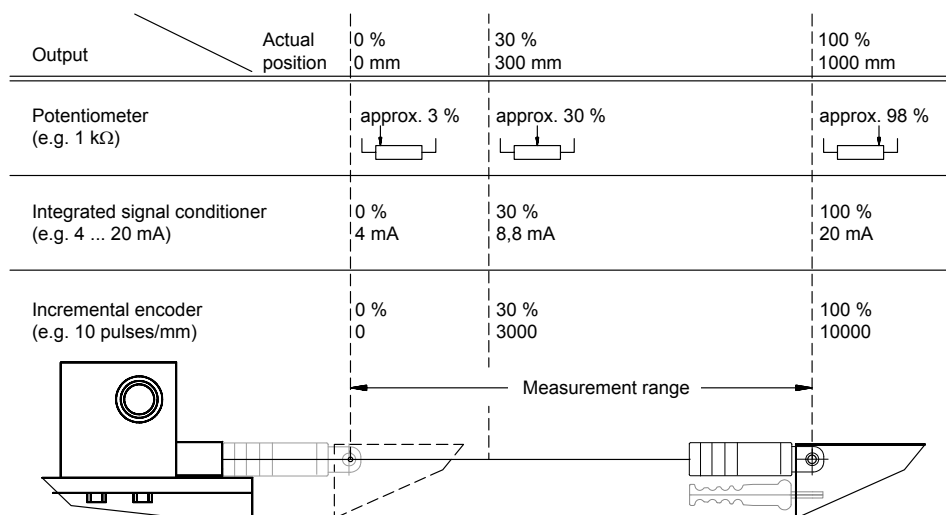

Delivery / shipment

Unpacking

Do not unpack sensor by pulling tape or tape clip.

Shipment damages

Check sensor immediately for shipping damage.

Shipment protection loop
(not to be confused with the mounting loop!)

Do not remove until mounting.
(prevents tape movement before mounting)

In case of any damage or equipment not operating appropriately, please contact supplier or ASM GmbH Moosinning. To avoid shipment damages, use original protection facilities and original packing for further shipment.

Installation



CAUTION

Do not damage tape!

Tape must not be oiled or lubricated!

Do not snap the tape!

Do not travel over range!

Do not crack the tape!

Tape travel should be axial to the tape outlet - no misalignment allowed!

Do not drag tape along objects!

Precautions

Do not let snap the tape

Uncontrolled retraction of tape may damage sensor.

No warranty will be granted for snapped cables.

Mounting

To ensure proper operation, install the sensor only as described in this manual.



Installation
(continuation)

Installation position

Covered or shielded travel of tape is preferred.

This prevents tape from damage, soiling and manipulation.

Tape outlet is preferred pointing downwards.

Soaking of liquids into the tape outlet is impossible, concentration of condensing water will be avoided.

Fit sensor on plain base or use three-point mounting on uneven surfaces.

This prevents sensor from bending and damage.

Tape travel should only be axial to the tape outlet

- no misalignment is allowed.

Tape misalignment shortens service life of sensor and causes error in measurement. Warranty will not be granted for damage caused by misalignment.

If tape travel axial to the tape outlet is not possible, the tape guide wheel WBR1 (accessories) must be used in order to turn the tape.

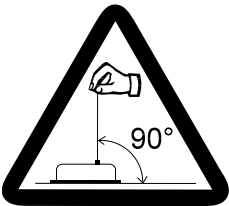

Fitting the sensor

Depending upon the sensor model, drillings in the base plate or threads in the sensor housing enable attachment of the sensor. Dimensions required are listed in the catalog.

Tape attachment device

For fastening the tape clip the 5 mm dia. bore is provided.

**Calibration
(ISO9001)**

The recommended calibration interval is 1 year.

Test protocol and traceable calibration certificate (ISO9001) is available on request.

**Electromagnetic
Compatibility
(EMC)**

The electromagnetic compatibility depends on wiring practice. Recommended wiring:

- Use shielded twisted pair sensor tape.
- Ground shield single ended at switch cabinet. Connect shield directly before or at tape inlet of switch cabinet by low impedance ground tape bond. On delivery of preassembled sensor cables the shield is not connected to the sensor housing.
- Keep sensor signal well separated from power wiring e.g. AC wiring, motor or relay. Use separate conduit or ducts for each.

If application includes highly electromagnetic interference emitting equipment like switch converter drives additional measures are recommended:

- Use a twisted pair tape, shielded per pair and common.
- Use shielded conduits or ducts connected to ground potential.

**Repair and
Disposal**



DANGER

Sensors and accessories have to be repaired and adjusted at ASM in Moosinning.

In order to avoid risk of injury and improper handling do not try to repair. No warranty or liability will be granted for opened sensors.

Disposal: Send metal parts for recycling!

POSITAPE® Instruction Manual Output specification



U2R Voltage output 0.5 ... 10 V 	Excitation voltage	10 ... 36 V DC
	Excitation current	typ. 22 mA at 24 V DC typ. 43mA at 12 V DC max. 60 mA per canal
	Output voltage	0,5 ... 10 V DC
	Output current	2 mA max.
	Measuring rate	1 kHz standard
	Stability (temperature)	$\pm 50 \times 10^{-6}/^{\circ}\text{C}$ f.s. (typ.)
	Protection	Reverse polarity, short circuit
	Operating temperature	-40 ... +85 °C
	EMC	EN61326-1:2006
U8R Voltage output 0.5 ... 4,5 V 	Excitation voltage	10 ... 36 V DC
	Excitation current	typ. 20mA at 24 V DC typ. 38mA at 12 V DC max. 60 mA per canal
	Output voltage	0,5 ... 4,5 V DC
	Output current	2 mA max.
	Measuring rate	1 kHz standard
	Stability (temperature)	$\pm 50 \times 10^{-6}/^{\circ}\text{C}$ f.s. (typ.)
	Protection	Reverse polarity, short circuit
	Operating temperature	-40 ... +85 °C
	EMC	EN61326-1:2006
I1R Current output 4 ... 20 mA, 3 wire 	Excitation voltage	10 ... 36 V DC
	Excitation current	typ. 39 mA at 24 V DC typ. 76 mA at 12 V DC max. 100 mA per canal at 20 mA
	Load R_L	500 Ω max.
	Output current	4 ... 20 mA
	Measuring rate	1 kHz standard
	Stability (temperature)	$\pm 50 \times 10^{-6}/^{\circ}\text{C}$ f.s. (typ.)
	Protection	Reverse polarity, short circuit
	Operating temperature	-40 ... +85 °C
	EMC	EN61326-1:2006

Output signals

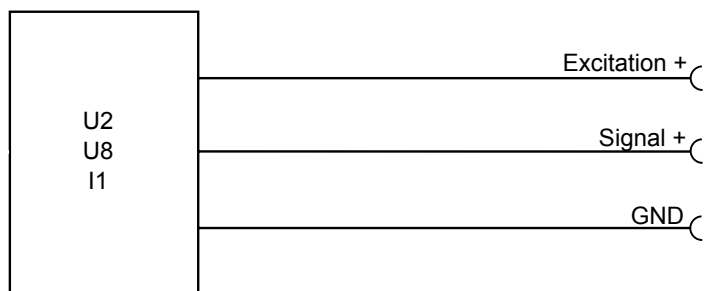
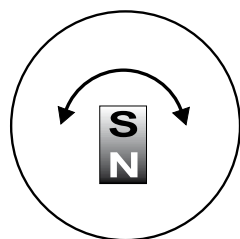

Signal Wiring	Output signals	Connector pin	Cable output Wire color
	Excitation +	1	brown
	Signal	2	white
	GND	3	blue
	Do not connect!	4	black
	SPAN/ZERO (option PMU)	5	grey

Connection

View to sensor
connector

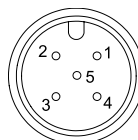

CONN-M12-5F

Signal wiring, redundant version with 2 channels and 1 connector	Connector M12, 8 pins	Channel	Signal
	1	1	Excitation +
	2	1	Signal
	3	1	GND
	4	1	SPAN/ZERO (option PMU)
	5	2	Excitation +
	6	2	Signal
	7	2	GND
	8	2	SPAN/ZERO (option PMU)

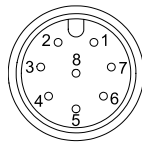

View to sensor
connector

Option -PMU

Programming of the start and end value by the customer

Teach-In of start and end value for the options U2/PMU, I1/PMU, U8/PMU is provided by a binary signal SPAN/ZERO. At the start position connect signal SPAN/ZERO for a period of 2 ... 3 seconds to GND via push button. At the end position connect signal SPAN/ZERO for a period of 5 ... 6 seconds to GND via a push button. The teach-ed positions will be stored non-volatile.

To reset the sensor to factory default signal ZERO/END must be connected to ground while powering up the sensor for 2 ... 3 seconds. For the option PMZ only teach-in of ZERO position is possible.

POSITAPE® Instruction Manual Output specification



MSSI Synchronous serial SSI 	Interface	EIA RS-422
	Excitation voltage	8 ... 36 V DC
	Excitation current	typ. 19 mA at 24 V DC typ. 35 mA at 12 V DC max. 80 mA
	Clock frequency	100 kHz ... 500 kHz
	Code	Gray-Code, continuous progression
	Delay between pulse trains	20 µs min.
	Stability (temperature)	$\pm 50 \times 10^{-6} / ^\circ\text{C}$ f.s. (typ.)
	Operating temperature	-40 ... +85 °C
	Protection	Short circuit
	EMC	EN61326-1:2006

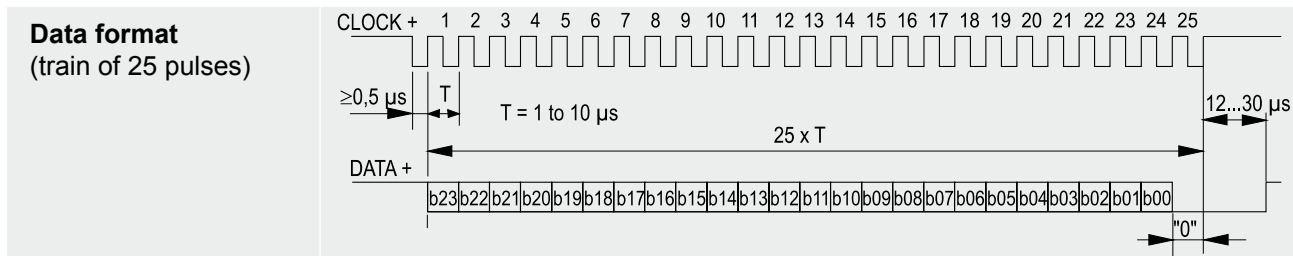

Recommended processing circuit

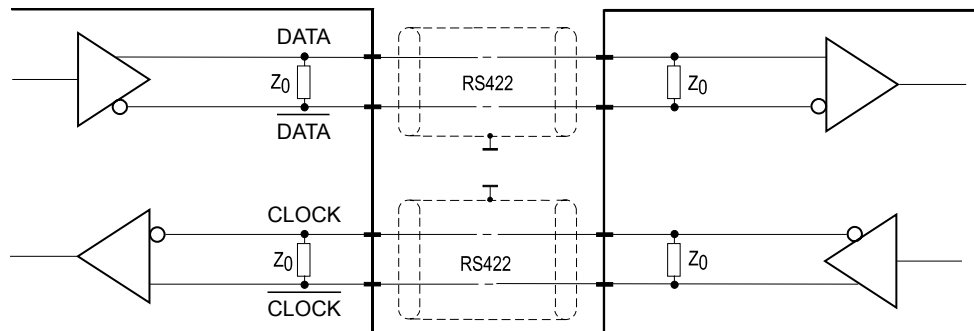

Transmission rate	Cable length	Baud rate
	50 m	100-400 kHz
	100 m	100-300 kHz

Note:
Extension of the cable length will reduce the maximum transmission rate.

Signal wiring/ Connection	Signal	Connector Pin	Cable wire color
	Excitation +	1	white
	Excitation	2	brown
	GND		
	CLOCK	3	green
	$\overline{\text{CLOCK}}$	4	yellow
	DATA	5	grey
	$\overline{\text{DATA}}$	6	pink
	-	7	blu
	-	8	red

View to sensor connector

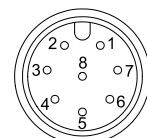

CONN-M12-8F

Description

Tape extension position sensor with CANopen interface according to CiA 406.

<p>MCANOP</p> 	Communication profile	CANopen CiA 301 V 4.02, Slave
	Device profile	Encoder CiA 406 V 3.2
	Configuration services	Layer Setting Service (LSS), CiA Draft Standard 305 (transmission rate, node id)
	Error Control	Node Guarding, Heartbeat, Emergency Message
	Node ID	Default: 127; programmable via LSS or SDO
	PDO	3 TxPDO, 0 RxPDO, static mapping
	PDO Modes	Event-/Time triggered, Remote-request, Sync cyclic/acyclic
	SDO	1 server, 0 client
	CAM	8 cams
	Transmission rates	50 kBaud to 1 MBaud, default: 125 kBaud; programmable via LSS or SDO
	Bus connection	M12 connector, 5 pins
	Integrated terminating resistor	$R_T = 120 \Omega$, user programmable
	Bus, galvanic isolated	No

Specifications	Excitation voltage	8 ... 36 V DC
	Excitation current	typ. 20 mA at 24 V DC typ. 40 mA at 12 V DC max. 80 mA
	Measuring rate	1 kHz (asynchronous)
	Stability (temperature)	$\pm 50 \times 10^{-6} / ^\circ\text{C}$ f.s.
	Repeatability	1 LSB
	Operating temperature	-40 ... +85 °C
	Protection	Reverse polarity, short circuit
	Dielectric strength	1 kV (V AC, 50 Hz, 1 min.)
	EMC	EN 61326-1:2006

Setup

Before connecting to the CAN bus make sure that all nodes have a different node ID and the same bit rate. If necessary set node ID and bit rate by the Layer-Setting-Service (LSS) as defined in Standard CiA DSP-305.

If LSS is not available node ID and bit rate can be changed by writing the new values to objects 2000 and 2010 via Service Data Object (SDO). New node ID and bit rate become effective not before "SAVE" and resetting the device.

After power up the slave will send a boot-up message and will be ready for configuration and start of data exchange. On first power-up the default parameters are effective.

Change parameters and operating mode of process data objects after importing the EDS file by the master software. Changed parameters become effective immediately. Parameters will become non-volatile on writing "SAVE" to object 1010-1.

Note: Setting of some parameters may have influence on the function of other parameters, e.g. changing the resolution may also influence the cam function.



Warning notice

- Changing the parameters can cause a sudden step of the instantaneous value and can result in unexpected machine (re)actions!
- Precautions to prevent danger for man or machine are necessary!
- Execute parametrizing at standstill of the machine only!

Device profile

	Index	Default	Value range
SAVE	1010-1	„save“	MSB...LSB 73h, 61h, 76h, 65h
LOAD	1011-1	„load“ *)	MSB...LSB 6Ch, 6Fh, 61h, 64h
Manufacturer-specific			
Node ID	2000	127	1...127
Bitrate	2010	4	0...7 (s. table below)
Termination resistor	2020	0	0 (off) / 1 (on)
Hysteresis (change of state)	2040	10	0 ... 1000
User Offset	2100	0	$-2^{31} \dots 2^{31}-1$
Filter	2102	1	1...255
Linear encoder CiA406			
Operating Parameters	6000-0	0	0...7
Total Measuring Range	6002-0	f.s. in mm	Model specific
Preset Value	6003-0	0	
Position Value	6004-0		
Cyclic Timer	6200-0	100	10 ... 30000
Measuring Step	6505-0	10 µm	
Profile and SW Version	6507-0		
Serial Number	650B-0		
Cam function CiA406			
Cam state register	6300-1	0	
Cam enable register	6301-1	0	
Cam polarity register	6302-1	0	
Cam 1-8 low limit	6310-1...6317-1	0	
Cam 1-8 high limit	6320-1...6327-1	0	
Cam 1-8 hysteresis	6330-1...6337-1	0	

*) Restore factory configuration except bitrate and node ID

Operating Parameters Bit Code

15	4	3	2	1	0
						sfc		cs
MSB								LSB

cs = 0/1 Code sequence CW/CCW

sfc = 0/1 Scaling function disabled/enabled

Bit rates	Index	Bit rate
	0	1 MBit/s
	1	800 kBit/s
	2	500 kBit/s
	3	250 kBit/s
	4	125 kBit/s
	5	reserved
	6	50 kBit/s
	7	20 kBit/s

Process data

PDO	Content	Preselected transmission mode
TxPDO-01	Position value (4 Byte)	Change of State Mode
TxPDO-02	Position value (4 Byte)	Sync Mode
TxPDO-04	CAM Status (1 Byte)	Asynchronous

CAM function

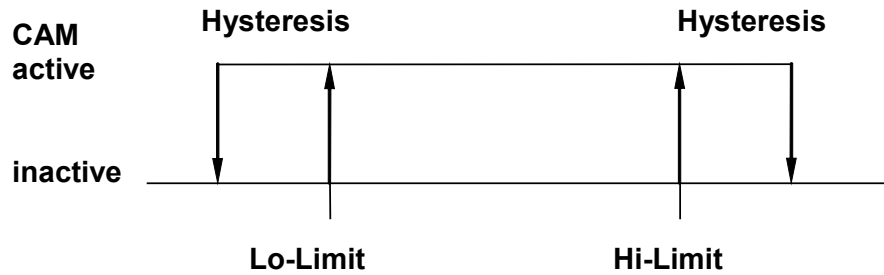

Signal wiring / connection

Signal name	Connector pin	Wire color
Shield	1	Braid
Excitation +	2	Brown
GND	3	White
CAN-H	4	Blue
CAN-L	5	Black

View to sensor connector

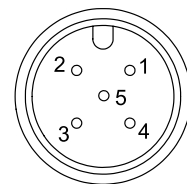

CAN bus wiring

Connect the device by a T-connector to the CAN trunk line. Total length of stubs should be minimized. Do not use single stub lines longer than 0.5 m. Connect terminating resistors 120 Ohm at both ends of the trunk line.

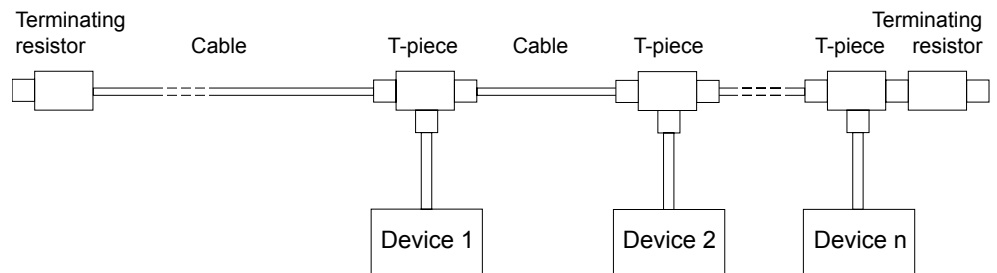

Description

Linear encoder according to standard SAE J1939. Customer configuration of operating parameters by Peer-to-Peer. Process data exchange by Broadcast message.

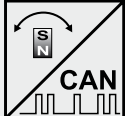
MCANJ1939 	CAN specification	ISO 11898, Basic and Full CAN 2.0 B
	Transceiver	24V-compliant, not isolated
	Communication profile	SAE J1939
	Baud rate	250 kBit/s
	Internal termination resistor	120 Ω user programmable
	Address	Default 247d, configurable

NAME Fields	Arbitrary address capable	1	Yes
	Industry group	0	Global
	Vehicle system	7Fh (127d)	Non specific
	Vehicle system instance	0	
	Function	FFh (255d)	Non specific
	Function instance	0	
	ECU instance	0	
	Manufacturer	145h (325d)	Manufacturer ID
	Identity number	0nnn	Serial number 21 bit

Parameter Group Numbers (PGN)	Configuration data	PGN EFddh	Proprietary-A (PDU1 peer-to-peer) dd Sensor Node ID
	Process data	PGN FFnnh	Proprietary-B (PDU2 broadcast); nn Group Extension (PS) configurable

Specifications	Excitation voltage	8 ... 36 V DC
	Excitation current	yp. 20 mA at 24 V DC typ. 40 mA at 12 V DC max. 80 mA
	Resolution	10 μm
	Measuring rate	1 kHz (asynchronous)
	Stability (temperature)	±50 x 10 ⁻⁶ / °C f.s.
	Repeatability	1 LSB
	Operating temperature	-40 ... +85 °C
	Protection	Reverse polarity, short circuit
	Dielectric strength	1 kV (V AC, 50 Hz, 1 min.)
	EMC Automation	EN 61326:2006

Setup

Node-ID

The default Node-ID the sensor will claim on power up is user or factory configurable. The user can configure by "Commanded Address" service according to the J1939 standard or by Peer-to-Peer message as described below.

User configuration

User accessible parameters including node-id may be configured by peer-to-peer proprietary A message PGN 0EF00h. The parameters are accessed by byte-index and read/write operations coded in the data frame. The slave will return the data frame including the acknowledge code. Parameter values will be effective immediately. On execution of "Store Parameters" the configuration is saved nonvolatile.

Peer-to-peer message (PGN 0x00EF00), send/receive format

PGN		8 Byte data frame							
PGN _{HIGH}	PGN _{LOW} (Node-ID)	Index	Rd/Wr	0	Ack	4-Byte Data			

Request: Control Unit → Sensor

→	0EFh	dd	i	0/1	0	0	LSB	MSB
---	------	----	---	-----	---	---	-----	----	----	-----

Response: Control Unit ← Sensor

←	0EFh	cc	i	0/1	0	a	LSB	MSB
---	------	----	---	-----	---	---	-----	----	----	-----

- a: Acknowledge codes:
 0: Acknowledge, 81: Read only parameter, 82: Range overflow,
 83: Range underflow, 84: Parameter does not exist
- dd: Sensor Node-ID (Default 0F7h, 247d)
- cc: Control-Unit Node-ID



Warning notice

- Changing the parameters can cause a sudden step of the instantaneous value and can result in unexpected machine (re)actions!
- Precautions to prevent danger for man or machine are necessary!
- Execute parametrizing at standstill of the machine only!

Configuration examples

Example: Set Transmit Cycle to 10ms, Index 31, Node-ID 247d (F7h)

	PGN _{HIGH}	PGN _{LOW}	8 Byte data frame							
→	0EFh	F7h	1Fh	01h	00	00	0Ah	00	00	00
←	0EFh	cc	1Fh	01h	00	00	0Ah	00	00	00

Example: Read Transmit Cycle value, Index 31

→	0EFh	F7h	1Fh	00	00	00	00	00	00	00
←	0EFh	cc	1Fh	00	00	00	0Ah	00	00	00

Example: Store Parameters permanently, Index 28

→	0EFh	F7h	1Ch	01h	00	00	65h	76h	61h	73h
←	0EFh	cc	1Ch	01h	00	00	65h	76h	61h	73h

Reload factory defaults, Index 29

→	0EFh	F7h	1Dh	01h	00	00	64h	61h	6Fh	6Ch
←	0EFh	cc	1Dh	01h	00	00	64h	61h	6Fh	6Ch

Example: Broadcast (PGN_{Low} = 0FFh - Reload factory defaults of all sensors, Index 29

→	0EFh	0FFh	1Dh	01h	00	00	64h	61h	6Fh	6Ch
←	0EFh	cc	1Dh	01h	00	00	64h	61h	6Fh	6Ch

Encoder - Parameters

Parameter	Index [dec]	Default	Range / Selection	Unit	Read / Write
Control					
Node ID	20	247	128 ... 247		rd/wr ¹⁾
Baude rate	21	3 (250kB)	-		rd
Termination resistor	22	0	0/1 (off/on)		rd/wr ²⁾
Store parameters	28	-	"save" ³⁾		wr
Reload factory defaults	29	-	"load" ³⁾		wr ²⁾
Communication					
Transmit mode	30	0	0 timer 1 request 2 event		rd/wr
Transmit cycle	31	100	10 ... 65535	ms	rd/wr
PGN Group Extension	32	0	0 ... 255		rd/wr
Event mode hysteresis	38	0	0 ... 16383	steps	rd/wr
Process data byte order	39	0	0 little / 1 big endian		rd/wr
Measurement					
Code sequence	70	0	0 CW 1 CCW		rd/wr
Measuring step	73	2 ¹⁴	1 ... 2 ¹⁴	µm	rd/wr
Preset	74	0	0 ... 2 ¹⁴ - 1	steps	rd/wr
Averaging filter	77	1	1 ... 255		rd/wr
Identification					
SW Version	198	-	4 bytes	number	rd
Serial number	199	-	4 bytes	number	rd
Identity number	200	-	21 bit	number	rd

1) Write access to index 20 (change of node ID) is effective immediately and initiates address claiming

2) Effective on next power-up

3) „save“ MSB...LSB: 73h, 61h, 76h, 65h
 „load“ MSB...LSB: 6Ch, 6Fh, 61h, 64h

Broadcast access by PGN_{Low} = 0FFh addresses the specified index of all sensors

Depending on configuration ordered default settings may be different, refer to ASM homepage.

Process data

Process data are transmitted by broadcast proprietary-B-Message PGN 0x00FFxx where the low byte is configurable.

Data field of process data

B7	B6	B5	B4	B3	B2	B1	B0
Error				Position value			
Byte ^{*)}				MSB			LSB

^{*)} Error codes: 0 = no error, 1 = error

POSITAPE®
Instruction Manual
Output specification CAN SAE J1939



Signal wiring / connection	Signal name	Connector pin	Wire color
	Shield	1	Braid
	Excitation +	2	White
	GND	3	Brown
	CAN-H	4	Blue
	CAN-L	5	Black

View to sensor connector

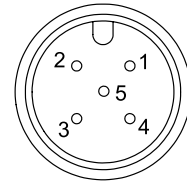

CAN Bus wiring

Connect the device by a T-connector to the CAN trunk line. Total length of stubs should be minimized. Do not use single stub lines longer than 0.5 m. Connect terminating resistors 120 Ohm at both ends of the trunk line.

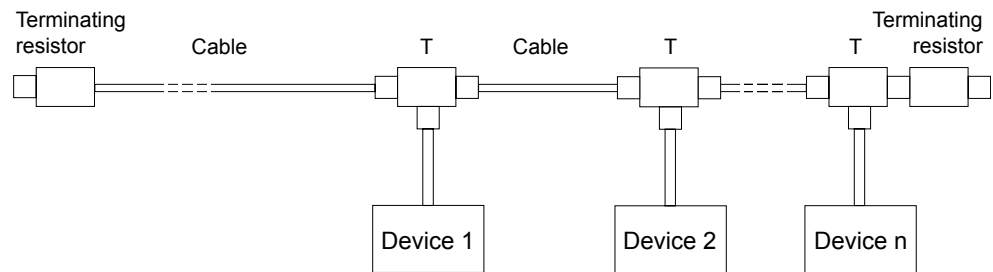

Models	WB10, WB12, WB17KT, WB21, WB25KT, WB27KT, WB61, WB85, WB100M	
Outputs	single-channel	
	U2	Voltage output 0,5 ... 10 V
	U8	Voltage output 0,5 ... 4,5 V
	I1	Current output 4 ... 20 mA
	MCANOP	CAN-BUS
	dual-channel	
	U2R	Voltage output 0,5 ... 10 V, redundant
	U8R	Voltage output 0,5 ... 4,5 V, redundant
	I1R	Current output 4 ... 20 mA, redundant
	MCANOPR	CAN-BUS, redundant
Characteristics	Device type	B
	Life period (electronics) $MTTF_d$	320 years / channel ^{*)}
	Probability of failure PFH (λ_{DU})	350 Fit / channel
	Life period (mechanics) B_{10}	$5 \cdot 10^6$ cycles (draft)
	Probability of failure (mechanics) λ_{MECH}	$0,1 \cdot C_h / B_{10}$ C_h = cycles per hour
	Working life	10 years
	Calibration intervall	annually
Operating conditions	Pull-out speed (max)	1 m/s
	Pull-in speed (max)	1 m/s
	Assembly	No deflection
Standards	Functional Safety	IEC 61508-1, -2, -6
	Safety of machinery	ISO 13849-1
	Failure rate of electronic components (Siemens)	SN 29500

^{*)} = Reference Conditions: Reference Supply Voltage $U_{B,REF} = 24$ V, Reference Temperature $\vartheta_{REF} = 60$ °C

Declaration of Conformity



We **ASM GmbH**
Am Bleichbach 18 - 22
D-85452 Moosinning

declare under our sole responsibility that the product

Name: Position sensor

Type: **WB10, WB12, WB17KT, WB21, WB25KT, WB27KT, WB61, WB85
WB100M**

to which this declaration relates is in conformity with the following standards or other normative documents:

Directives: 2004/108/EG (EMC)

Standards: EN 61326-1:2006-10 (EMC)

The tests were carried out with the sensor cable type KAB-5M-DIN/8F/W-LITZE (manufacturer: ASM GmbH), cable length 5 m, connected to the display panel meters type PD-ADC (manufacturer: ASM GmbH).

Moosinning, 28.4.2010



p.p. Andreas Bolm
Quality Manager



p.p. Peter Wirth
Head of Development



A large area of the page is filled with horizontal dotted lines, providing a space for handwritten notes.

ASM GmbH Automation • Sensorik • Messtechnik

Am Bleichbach 18-22

Telephone: +49 8123 986-0

Internet: www.asm-sensor.com

E-Mail: info@asm-sensor.de

85452 Moosinning / Germany

Telefax: +49 8123 986-500

