

POSIWIRE® WS17KT Analog, SSI or CANopen Output

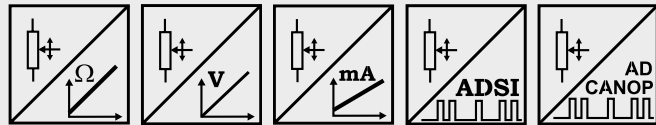

Compact sensor for medium ranges

- Protection class IP64 (as option IP66)
- Measurement range 0 ... 1500 mm to 0 ... 15000 mm
- Analog output or
A/D converted synchronous serial output (SSI) or
A/D converted CANopen output



Specifications	Outputs	Potentiometer 1 kΩ Voltage 0 ... 10 V Current 4 ... 20 mA, 2 or 3 wire Voltage or current output, programmable (PMUV/PMUI) A/D converted synchronous serial interface (SSI) A/D converted CANopen bus
	Resolution	Analog: essentially infinite ADSI16: max. 16 bit f.s. ADCANOP: 16 bit f.s.
	Linearity	Up to ±0.05% f.s.
	Sensing device	Precision potentiometer
	Material	Aluminum and stainless steel; cable: stainless steel
	Protection class	IP64 (with mating connector only), IP66 as option
	Connection	Male 8 pin socket M12 (ADCANOP: 5 pin socket)
	Weight	See table next page
	EMC, temperature	Refer to output specification

Order code WS17KT

WS17KT - [] - [] - [] - [] - []

Model name

Measurement range (in mm)

1500 / 2000 / 2500 / 3000 / 4000 / 5000 / 6250 / 10000 / 12500 / 15000

Output

R1K = Potentiometer 1 kΩ
 10V = 0 ... 10 V signal conditioner
 420A = 4 ... 20 mA signal conditioner
 420T = 4 ... 20 mA signal conditioner
 PMUV/PMUI = Programmable 0... 10 V or 4 ... 20 mA signal conditioner
 ADSI16 = A/D converted synchronous serial interface 16 bit (12 or 14 bit opt.)
 ADCANOP = A/D converted CANopen bus

Linearity

L10 = ±0.10 % option: L05 = ±0.05 % L25 = ±0.25 %

Cable fixing

M4 = M4 cable fixing
 SB0 = Cable clip

Connection

M12 = 8 pin socket M12 (not for ADCANOP)
 M12/CAN = 5 pin socket M12 (only for ADCANOP)

Order code connector cable: see page 82/83

Order example: WS17KT - 2500 - 420T - L10 - M4 - M12

POSIWIRE®
WS17KT
Analog, SSI or CANopen output



Cable forces, typical at 20 °C	Measurement range	Weight (approx.)	Max. pull-out force	Min. pull-in force
	[mm]	[kg]	[N]	[N]
	1500	1.4	11.0	6.2
	2000	1.4	8.5	4.8
	2500	1.5	5.5	3.5
	3000	2.9	14.5	10.3
	4000	2.9	12.7	9.1
	5000	5.3	13.0	9.3
	6250	5.5	10.2	7.3
	10000	6.0	16.5	9.1
	12500	6.0	16.5	9.1
	15000	6.0	16.5	9.1

Outline drawing
WS17KT-1500 /
2000 / 2500

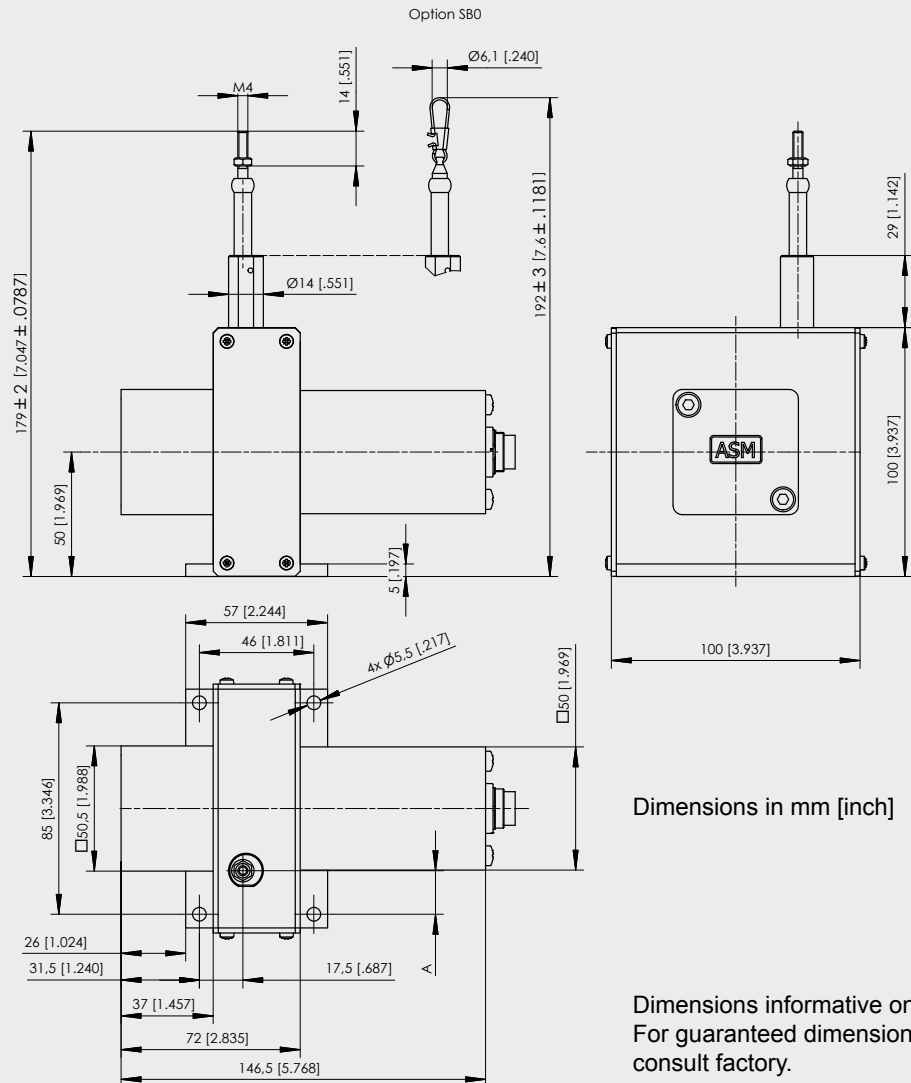

Dimensions in mm	Measurement range	Dimension A
	1500	17.5
2000	9.5	
2500	2.5	

POSIWIRE®
WS17KT
Analog, SSI or CANopen Output



Outline drawing
WS17KT-3000 / 4000

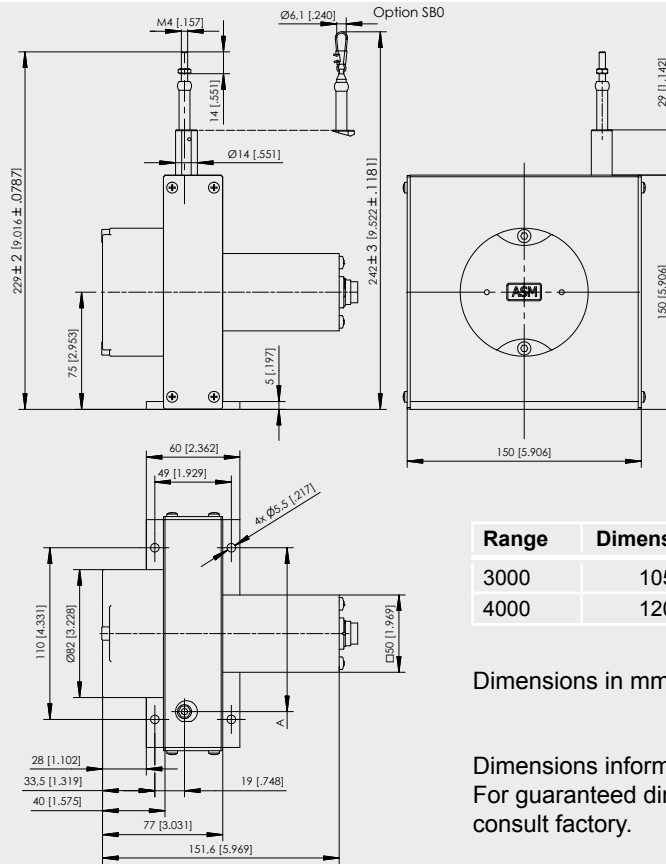

Outline drawing
WS17KT-5000 / 6250

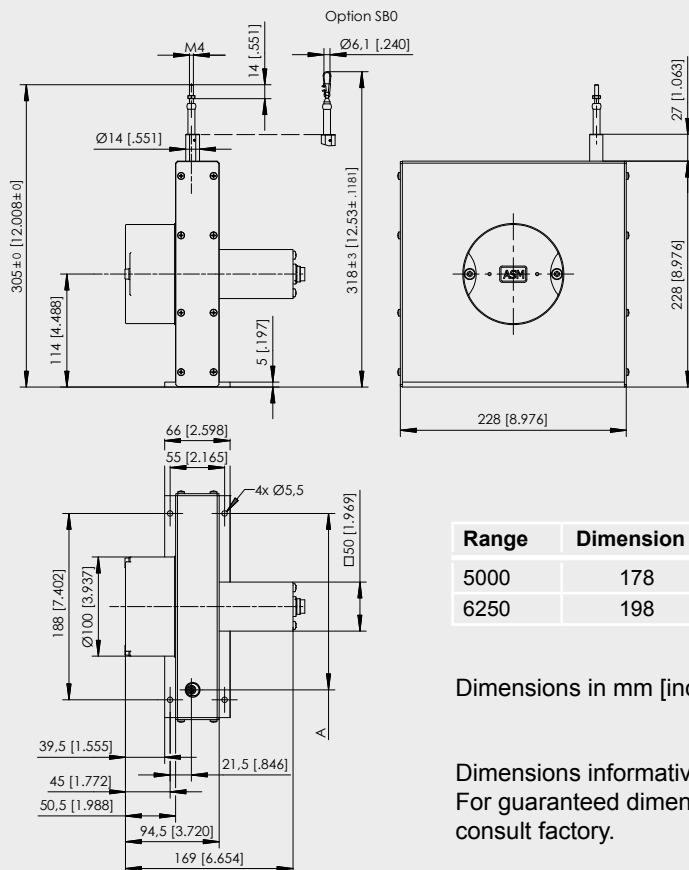

POSIWIRE®
WS17KT
Analog, SSI or CANopen output



Outline drawing
 WS17KT-10000 /
 12500 / 15000

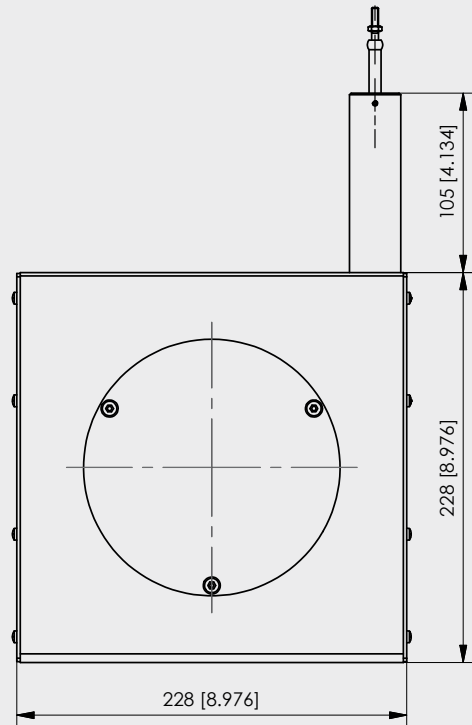
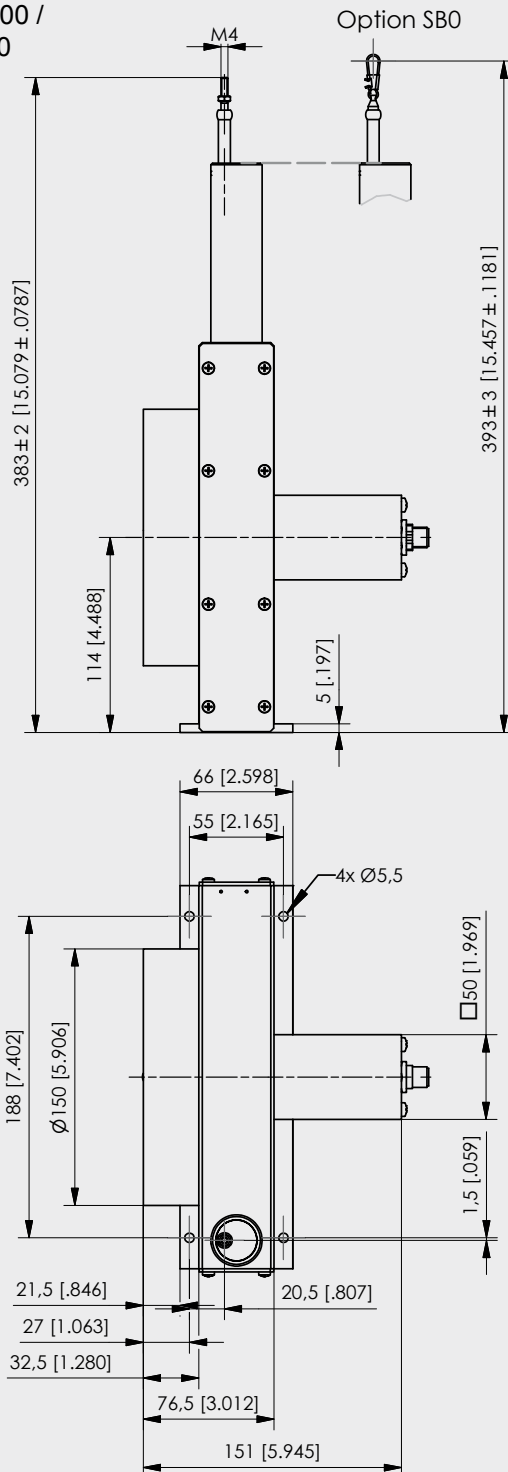

Dimensions in mm [inch]

Dimensions informative only.
 For guaranteed dimensions consult factory.

POSIWIRE® R1K and 10V Analog Output



Voltage divider R1K Potentiometer 	Excitation voltage	32 V DC max. at 1 kΩ (max. power 1 W)
	Potentiometer impedance	1 kΩ ±10 %
	Thermal coefficient	±25 x 10 ⁻⁶ / °C f.s.
	Sensitivity	Depends on the measuring range, individual sensitivity of the sensor is specified on the label
	Voltage divider utilization range	Approx. 3 % ... 97 %
	Operating temperature	-20 ... +85 °C

Output signals

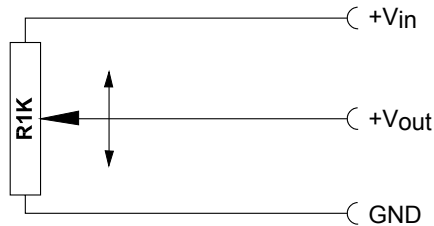

Note: The Potentiometer must be connected as a voltage divider. The input impedance of the following processing circuit should be 10 MΩ min.

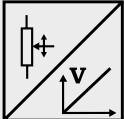
Signal conditioner 10V and 10V5 Voltage output 	Excitation voltage	18 ... 27 V DC non stabilized
	Excitation current	20 mA max.
	Output voltage	10V: 0 ... 10 V DC; 10V5: 0.5 ... 10 V DC
	Output current	2 mA max.
	Output load	> 5 kΩ
	Stability (temperature)	±50 x 10 ⁻⁶ / °C f.s.
	Protection	Reverse polarity, short circuit
	Output noise	0.5 mV _{RMS}
	Operating temperature	-20 ... +85 °C
	EMC	According EN 61326:2006

Output signals



Signal wiring	Signal name R1K	10V	Cable color	Connector pin no.
	+Vin	Excitation +	White	1
	GND	Excitation GND	Brown	2
	+Vout	Signal +	Green	3
		Signal GND	Yellow	4

Connection

View to sensor connector

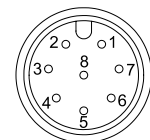

CONN-M12-8F

POSIWIRE® 420A and 420T Analog Output

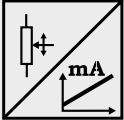

Signal conditioner 420A Current output (2 wire) 	Excitation voltage	12 ... 27 V DC non stabilized, measured at the sensor terminals
	Excitation current	35 mA max.
	Output current	4 ... 20 mA equivalent for 0 ... 100 % range
	Stability (temperature)	$\pm 100 \times 10^{-6} / ^\circ\text{C}$ f.s.
	Protection	Reversed polarity, short circuit
	Output noise	0.5 mV _{RMS}
	Operating temperature	-20 ... +85 °C
	EMC	According to EN 61326:2006

Output signals

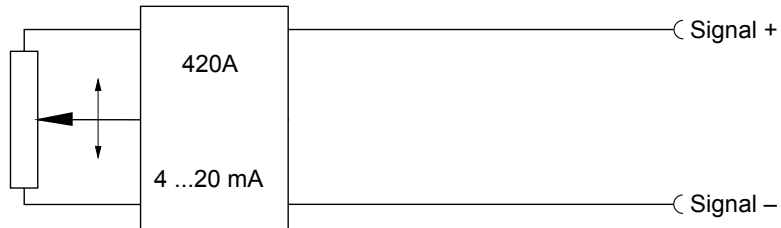

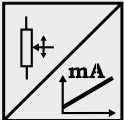
Signal conditioner 420T Current output (3 wire) 	Excitation voltage	18 ... 27 V DC non stabilized
	Excitation current	40 mA max.
	Load resistor	350 Ω max.
	Output current	4 ... 20 mA equivalent for 0 ... 100 % range
	Stability (temperature)	$\pm 50 \times 10^{-6} / ^\circ\text{C}$ f.s.
	Protection	Reverse polarity, short circuit
	Output noise	0.5 mV _{RMS}
	Operating temperature	-20 ... +85 °C
	EMC	According to EN 61326:2006

Output signals



Signal wiring	Signal name		Cable color	Connector pin no.
	420A	420T		
Signal +		Excitation +	White	1
Signal -		Excitation GND	Brown	2
		Signal +	Green	3

Connection

View to sensor
connector

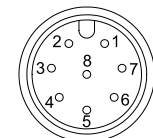

CONN-M12-8F

POSIWIRE® PMUV / PMUI Programmable Analog Output



Signal conditioner PMUV / PMUI Voltage or current output (3 wire)	Excitation voltage	18 ... 27 V DC
	Excitation current	50 mA max.
	Voltage output PMUV	0 ... 10 V
	Output current	10 mA max.
	Output load	1 kΩ min.
	Current output PMUI	4 ... 20 mA (3 wire)
	Working resistance	500 Ω max.
	Scaling	
	Activation of offset and gain adjust	Connect with excitation GND (0 V)
	Scalable range	90% max. f.s.
Stability (temperature)	±50 x 10 ⁻⁶ / °C f.s.	
Operating temperature	-20 ... +85 °C	
Protection	Reversed polarity, short circuit	
EMC	According to EN 61326:2006	

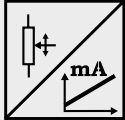
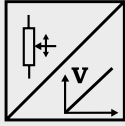

Output signals

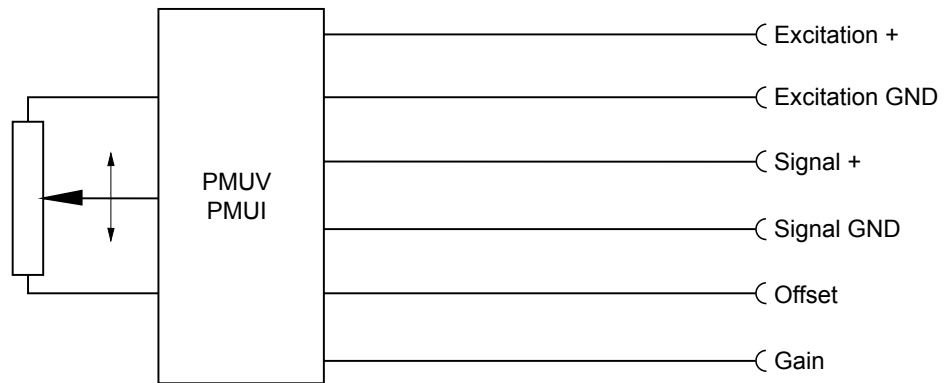

Signal name	Connector pin no.
Excitation +	1
Excitation GND	2
Signal +	3
Signal GND	4
Not used	5
Not used	6
Offset	7
Gain	8

Connection

View to sensor
connector

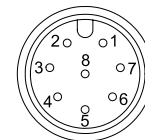

CONN-M12-8F

Signal name	Connector pin no.
Excitation +	1
Excitation GND	2
Not used	3
Not used	4
Signal +	5
Signal GND	6
Offset	7
Gain	8

POSIWIRE® ADCANOP A/D Converted CANopen Bus

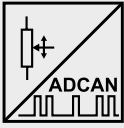

Interface ADCANOP 	Communication profile	CANopen CiA 301 V 4.02, Slave
	Encoder profile	Encoder CiA 406 V 3.2
	Error Control	Node Guarding, Heartbeat, Emergency Message
	Node ID	Adjustable via LSS
	PDO	3 TxPDO, 0 RxPDO, no linking, static mapping
	PDO Modes	Event-/Time triggered, Remote-request, Sync cyclic/acyclic
	SDO	1 server, 0 client
	CAM	2 cams
	Certified	Yes
	Transmission rates	50 kBaud to 1 MBaud, adjustable via LSS
	Nodes	127 max.
	Bus connection	M12 connector, 5 pins
	Integrated bus terminating resistor	No
	Bus, galvanic isolated	No

Specifications	Excitation voltage	8 ... 36 V DC
	Excitation current	Typ. 15/30 mA for 24/12 V, max. 100 mA
	Resolution	16 bit f.s.
	Measuring rate	1 kHz (asynchronous)
	Stability (temperature)	$\pm 50 \times 10^{-6}$ / °C f.s.
	Repeatability	1 LSB
	Operating temperature	-20 ... +85 °C
	Protection	Reverse polarity, short circuit
	Dielectric strength	1 kV (V AC, 50 Hz, 1 min.)
	Environment - EMC Automation	EN 61326:2006

Signal diagram

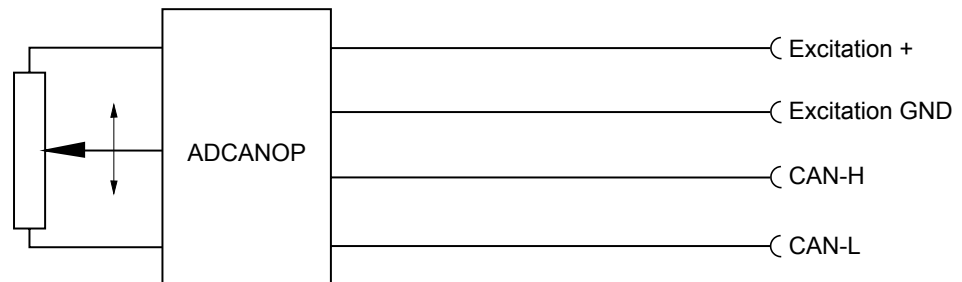

View to sensor connector

Signal wiring / connection	Signal name	Connector pin no.
	Shield	1
	Excitation +	2
	GND	3
	CAN-H	4
	CAN-L	5

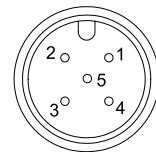

POSIWIRE®

ADSI16

A/D Converted SSI Output



- Resolution 16 bit, synchronous serial data transmission/SSI
- Optional available with 12 bit (ADSI) or 14 bit (ADSI14) resolution
- No loss of data at power down
- Easy to connect to PLC's with SSI input circuitry

Description

The sensing device of the ADSI is a precision potentiometer. The position information is given by an analog/digital converter output serialized as a data word. Data transmission takes place by means of the signals CLOCK and DATA. The processing unit (PLC, Micro-computer) sends pulse sequences which clock the data transmission with the required transfer rate. With the first falling edge of a pulse sequence the position of the sensor is recorded and stored. The following rising edges control the bit-by-bit A/D conversion, encoding and output of the data word. After a delay time the next new position information will be transmitted.

Signal conditioner ADSI16 A/D converted synchronous serial

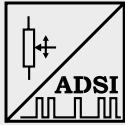

Interface	EIA RS422, RS485, short-circuit proof
Excitation voltage	11 ... 27 V DC
Excitation current	200 mA max.
Clock frequency	70 ... 500 kHz
Code	Gray code, continuous progression
Delay between pulse trains	30 µs min.
Resolution	16 bit (65536 counts) f.s.; optional 12 (ADSI) bit resp. 14 bit (ADSI14)
Stability (temperature)	±50 x 10 ⁻⁶ / °C f.s.
Operating temperature	-20 ... +85 °C
EMC	According to EN 61326:2006

Data format (train of 26 pulses)

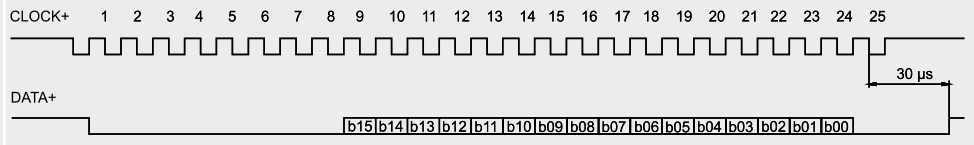

Recommended processing circuit

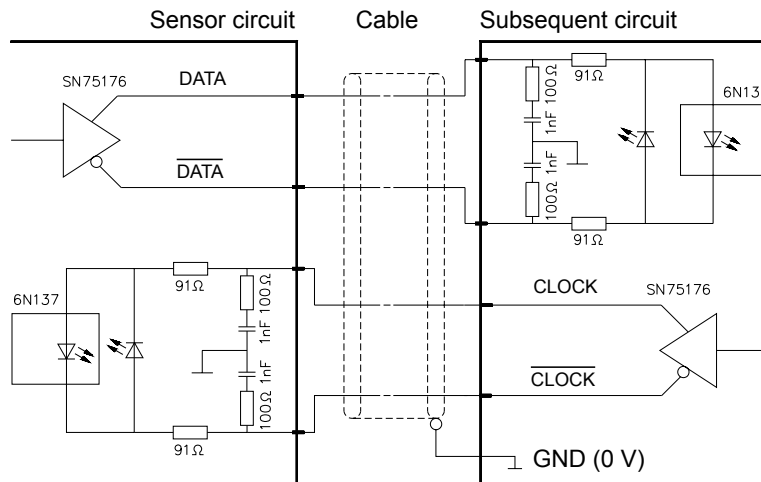

Transmission rate

Cable length	Baud rate
< 50 m	< 300 kHz
< 100 m	< 100 kHz

Note:

Extension of the cable length will reduce the maximum transmission rate.

Signal wiring

Signal name	Connector pin no.
Excitation +	1
Excitation GND (0 V)	2
CLOCK	3
CLOCK	4
DATA	5
DATA	6
Shield	not connected

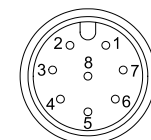

CONN-M12-8F

View to sensor
connector

POSIWIRE® Accessories for WS® Position Sensors



**Connector cable
for WS® position
sensors**
8 pin M12

The 8-lead shielded cable is supplied with a mating 8-pin 90° M12 connector at one end and 8 wires at the other end. Available lengths are 2 m, 5 m and 10 m. Wire: cross sectional area 0.25 mm².

Order code:

KAB - XM - M12/8F/W - LITZE
IP69K: KAB - XM - M12/8F/W/69K - LITZE

Length in m

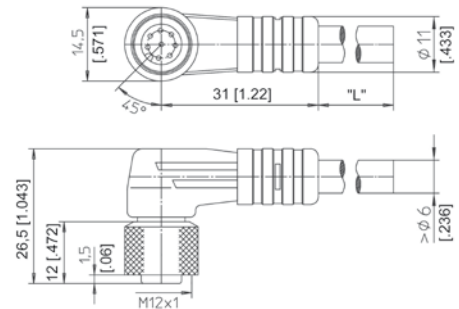

**Connector cable
for WS® position
sensors**
8 pin M12

The 8-lead shielded cable is supplied with a mating 8-pin M12 connector at one end and 8 wires at the other end. Available lengths are 2 m, 5 m and 10 m. Wire: cross sectional area 0.25 mm².

Order code:

KAB - XM - M12/8F/G - LITZE
IP69K: KAB - XM - M12/8F/G/69K - LITZE

Length in m

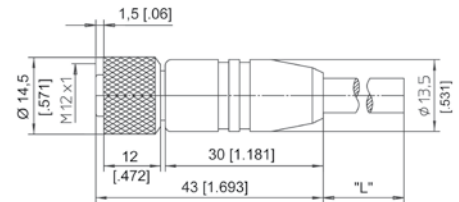

Connector cable wiring - M12, 8 pin	Connector pin / cable color							
	1	2	3	4	5	6	7	8
	White	Brown	Green	Yellow	Grey	Pink	Blue	Red

**Connector for WS®
position sensors**
12 pin CONIN

Female connector.

Order code:

CONN - CONIN - 12F - G

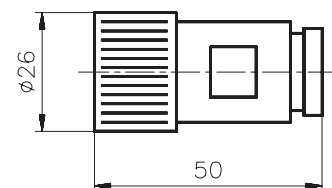

POSIWIRE® Accessories for WS® Position Sensors



Connector/bus cable for WS® position sensors

5 pin M12
CAN bus/DeviceNet

The 5-lead shielded cable is supplied with a female 5-pin M12 connector at one end and a male 5-pin M12 connector at the other end. Available lengths are 0.3 m, 2 m, 5 m and 10 m.

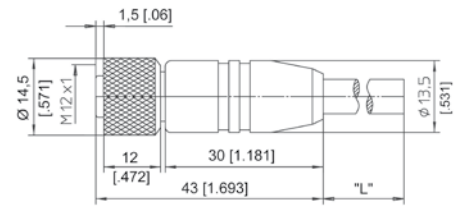

Order code:

KAB - XM - M12/5F/G - M12/5M/G - CAN

IP69K: KAB - XM - M12/5F/G/69K - M12/5M/G/69K - CAN

Length in m

T-piece for bus cable

5 pin M12
CAN bus/DeviceNet

Order code:

KAB - TCONN - M12/5M - 2M12/5F - CAN



Terminating resistance

5 pin M12
CAN bus/DeviceNet

Order code:

KAB - RTERM - M12/5M/G - CAN

