

THERMATEL® MODEL TG1/TG2

Installation and Operating Manual



**Model TG1/TG2
with twin tip sensor**



**Model TG1/TG2
with spherical tip sensor**

Thermal

Dispersion

Level/Flow/Interface

Switch



**Model TG1/TG2
with low flow body sensor**



**DIN rail
Model TG1**

UNPACKING

Unpack the instrument carefully. Make sure all components have been removed from the foam protection. Inspect all components for damage. Report any concealed damage to the carrier within 24 hours. Check the contents of the carton/crates against the packing slip and report any discrepancies to Magnetrol. Check the nameplate model number to be sure it agrees with the packing slip and purchase order. Check and record the serial number for future reference when ordering parts.



These units are in compliance with:

1. The EMC directive 2014/30/EU. The units have been tested to EN 61326: 1997 + A1 + A2.
2. Directive 2014/34/EU for equipment or protective system intended for use in potentially explosive atmospheres. EC-type examination certificate number ISSeP00ATEX006 (DIN Rail housing) and ISSeP00ATEX007X (sensor and sensor enclosure).
3. The PED directive 2014/68/EU (pressure equipment directive). Safety accessories per category IV module H1.

Pre-amplifier nameplate:
- partnumber
- serial n°
- tag n°

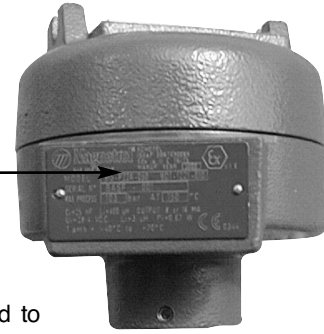

Amplifier nameplate:
- partnumber
- serial n°
- tag n°



SPECIAL CONDITIONS FOR ATEX INTRINSICALLY SAFE USE

- During the installation, the user and the installer shall ensure the internal temperatures of the enclosure containing the amplifier don't exceed + 70 °C (160 °F) under the worst unfavourable conditions. The worst unfavourable conditions are present with an external ambient temperature of + 70 °C (160 °F) and a maximum heating transmission by the installation. If one of these temperature exceeds + 70 °C (160 °F), either the high temperature version, or the standard one with enclosure extension shall be used.
- When the material is equipped with an aluminium enclosure, all precautions shall be taken in order to avoid all impacts or frictions which can cause ignition of the potentially explosive atmosphere.

MOUNTING

FLOW

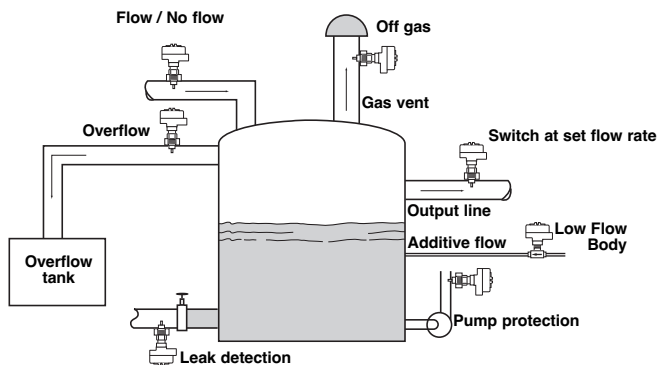

- Liquid or Gas flow detection
- Maintain a minimum flow rate
- Pump protection
- Cooling air/water
- Lubrication systems
- Chemical feed pumps
- Detect presence of flow
- Relief valves / Flare lines
- Water for Injection (WFI)
- Filtration systems
- Separation systems
- CIP systems
- Air, CO₂, N₂ flow

LEVEL

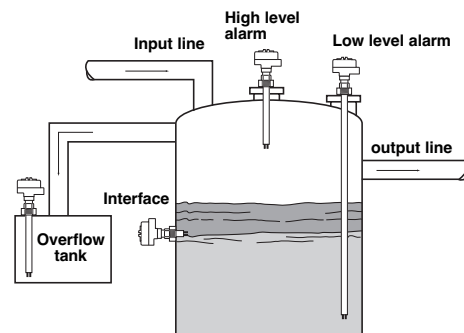

- High level or Low level
- Interface between different media
- Oil/water
- Liquid/foam
- Suitable for any liquid level detection including: High viscosity, High solids content, Aeration, Foam
- Insensitive to dielectric, specific gravity, viscosity

MOUNTING

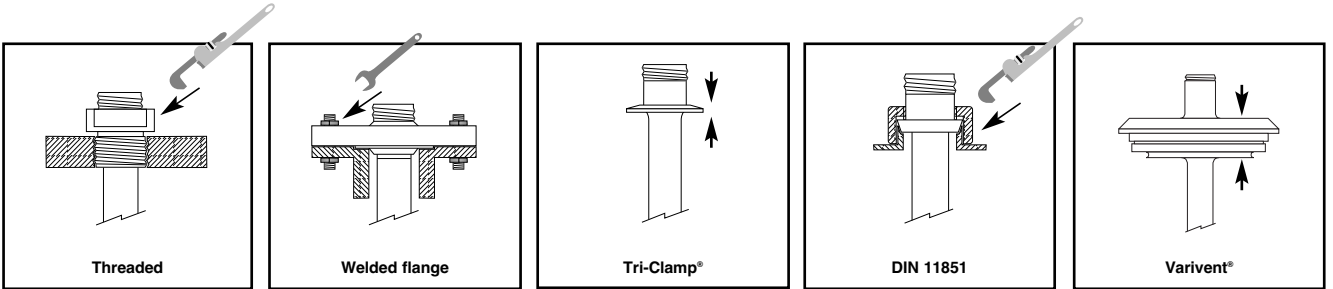
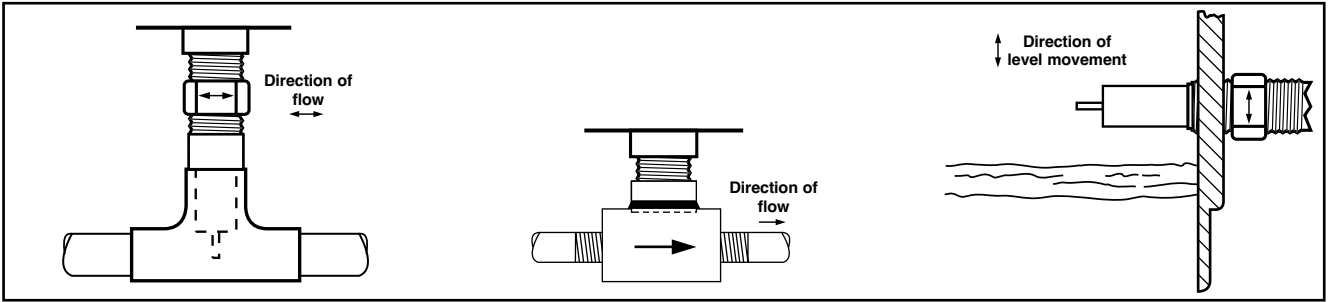

WIRING

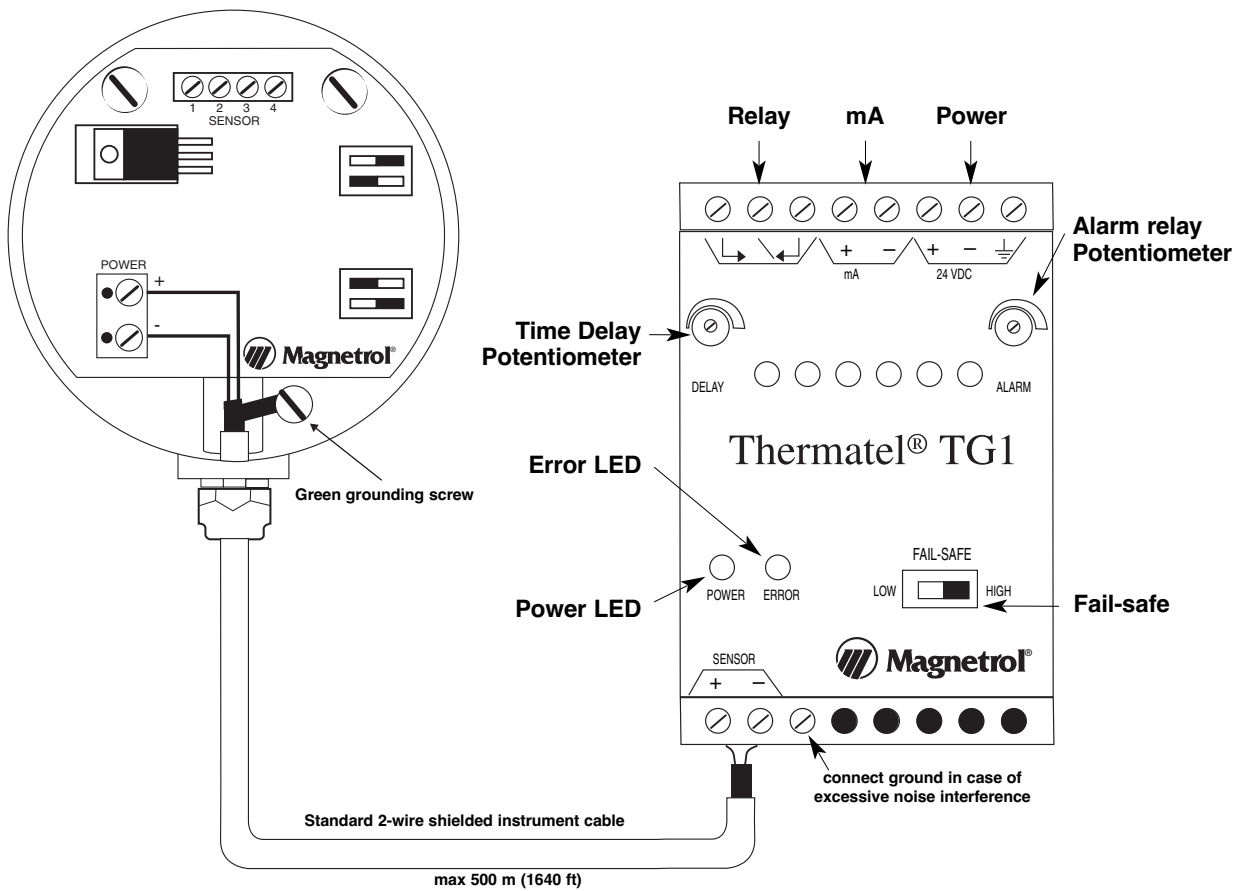

CALIBRATION

Pre-amplifier settings

For factory calibrated devices, the switch setup and calibration is completed by MAGNETROL for optimal performance in your application. The dip-switch settings and/or potentiometers should only be adjusted for troubleshooting purposes if the factory calibration was not sufficient.

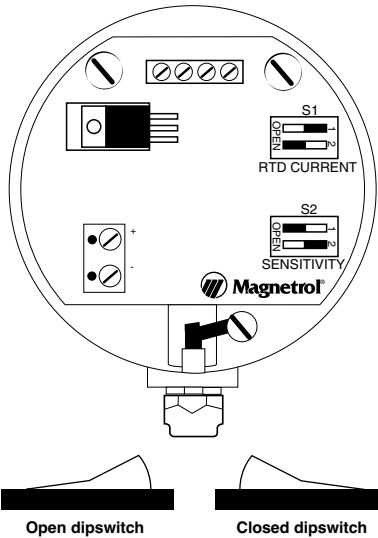

DIP switch positions	Default	Low flow gas	Temperatures $\geq +100\text{ }^{\circ}\text{C}$ (+212 $^{\circ}\text{F}$)	For TMH sensors
RTD current (S1)				
1	Closed	Open	Open	Closed
2	Open	Closed	Closed	Open
Sensitivity (S2)				
1	Open	Open	Open	Closed
2	Closed	Closed	Closed	Open

The units are factory set to the "Default" dip switch positions, except for units with TMH sensors as these are set to "For TMH sensors". These settings should be valid for most liquid level, interface and flow cases. For gaseous low flow applications or for specific liquid applications it may happen that the set point cannot be established. Change the settings in these cases from "Default" to "Low flow gas" depending what is needed to establish the setpoint.

NOTE: The settings on TMH sensors should never be changed.

Amplifier settings and LED indications

mA signal:

The mA is a non linear signal of the actual process conditions;
 - for flow: mA output increases as the flow rate increases
 - for level: mA output increases when in a wet condition.

Error reporting is determined by setting of the Fail Safe mode;
 - failsafe low $\leq 3,6\text{ mA}$
 - failsafe high $\geq 22\text{ mA}$

The mA value depends upon sensor and application.

Time Delay Potentiometer:
 Before calibration, turn fully counterclockwise until click (max. 20 turns) = 0 s

Error LED:
 OFF: unit operates normal
 BLINKS: unit has registered an error

Power LED:
 Unit powered = green LED ON

Alarm relay Potentiometer

LED indication:

TG1
 green LED ON = safe (one or more of the 4 green LED's)
 yellow LED ON = reaching switch point
 Red LED ON = alarm

TG2
 green LED ON = safe (one or more of the 4 green LED's)
 yellow LED ON = reaching switch point
 None = alarm

Fail-safe:

= Low level Fail-safe – the relay is energized when the flow is greater than the alarm point or when the sensor is immersed. The relay becomes de-energized when the flow is equal to or less than the alarm set point or when the sensor is dry (or in the low conductivity media)

= High level Fail safe – the relay is energized when the flow is less than the alarm point or when the level is lower than the less than the switch point. The relay will de-energize when the flow reaches or exceeds the alarm point or if the sensor becomes immersed (or in the high conductivity media).

CALIBRATION

For factory calibrated devices, the switch setup and calibration is completed by MAGNETROL for optimal performance in your application. The dip-switch settings and/or potentiometers should only be adjusted for troubleshooting purposes if the factory calibration was not sufficient.

NOTE: Ensure that settings on page 4 have been verified before calibrating this unit. Adjust level, interface or flow to the desired alarm condition. Units are preferably field calibrated under operating conditions or bench calibrated if the real conditions can be simulated. Consult factory when this cannot be established.

High flow / High level - Interface

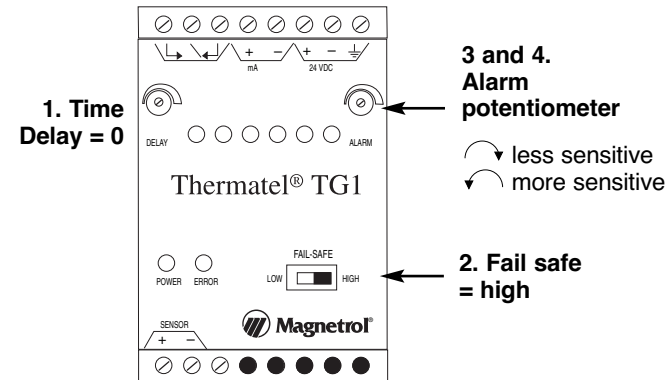

1. Set Time delay to minimum (turn max 20 turns counterclockwise or until a clicking sound is heard).
2. Set Failsafe switch in "High" mode.
3. Set Alarm potentiometer until:
 - red LED is ON for TG1 model
 - all LED's are OUT for TG2 model.
 Relay will be de-energized, as flow or level is higher than the actual set point or the unit sees the most conductive media.
4. Reset Alarm potentiometer until Red LED (TG1) is OFF and yellow LED lids UP (turn clockwise) – tweak the potentiometer slowly back and forth until the desired set point is reached = Red LED ON (TG1) / All LED's OUT (TG2).
5. Only for level applications: turn alarm potentiometer counterclockwise one additional turn.

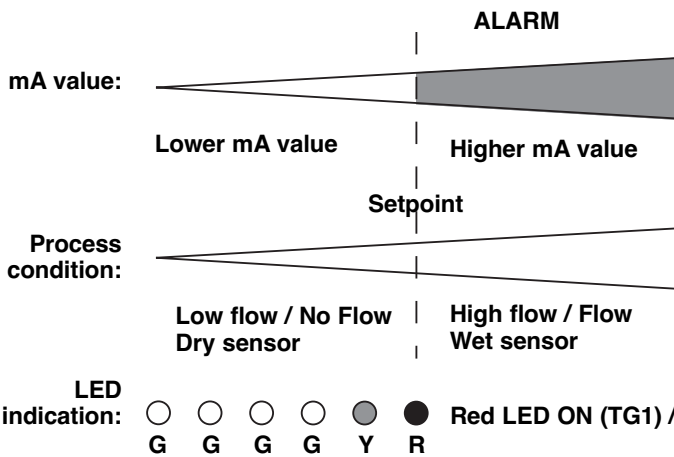

Low flow / No flow / Low level - Interface

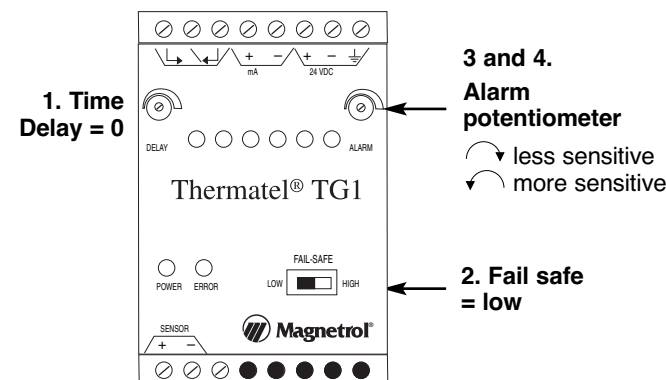

1. Set Time delay to minimum (turn max 20 turns counterclockwise or until a clicking sound is heard).
2. Set Failsafe switch in "Low" mode
3. Set Alarm potentiometer until: (turn counterclockwise)
 - red LED is ON for TG1 model
 - all LED's are OUT for TG2 model.
 Relay will be de-energized, as flow or level is lower than the actual set point or the unit sees the least conductive media.
4. Reset Alarm potentiometer until Red LED (TG1) is OFF and yellow LED lids UP (turn clockwise) – tweak the potentiometer slowly back and forth until the desired set point is reached = Red LED ON (TG1) / all LED's out (TG2)
5. Only for level applications: turn alarm potentiometer clockwise 1/2 additional turn.

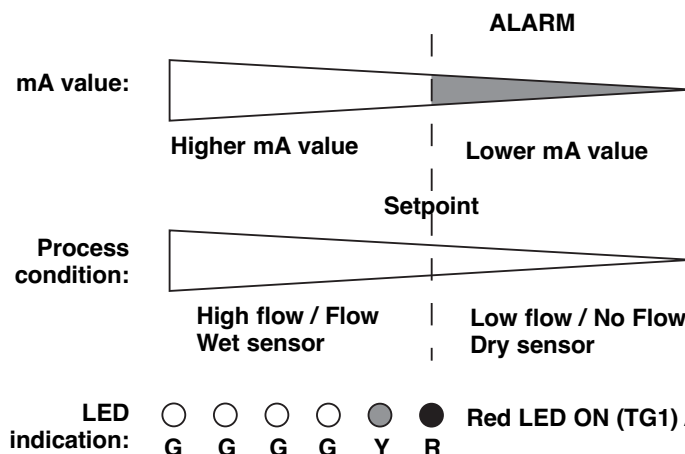

FAULT INDICATION

TG1/TG2 have continuous diagnostics to ensure that the signal from the sensor is within a select range. If the electronics detect an "out of range" signal, the switch has registered an instrument error.

3,6 mA signal when unit is set for low level fail-safe.

22 mA signal when unit is set for high level fail-safe.

Error LED blinks and the relay de-energizes.

If a fault is detected, refer to section "TROUBLESHOOTING".

TROUBLESHOOTING

The TG1/TG2 switches have various settings to handle a wide variety of flow and level applications. If the switch is not performing properly, check the switch settings on page 4 or the following:

Symptom (at DIN Rail electronics)	Problem	Solution
Yellow LED does not go ON	Switch point cannot be established	Adjust sensitivity in sensor housing (check S1 and S2 switch settings – see page 4) Check FAIL-SAFE position Check sensor connection
Green power LED OFF	No power	Check power supply Check wiring at power terminals
Red Error LED blinks and value is $\leq 3,6$ mA or ≥ 22 mA	A malfunction on the unit is detected	Check wiring to sensor Check wiring between electronics and sensor Voltage at sensor terminals on DIN Rail housing should read +/- 14 Volts Consult factory
Red Error LED blinks at high level/flow and turns OFF at low level/flow	Unit is set too sensitive	Change setting to "Lower" Sensitivity in sensor housing (check S1 and S2 switch settings – see page 4)

RESISTANCE VALUES

The following table provides the expected resistance values for the sensor. These should be within the specified limits. Before testing the resistance values of the wires, switch power off and disconnect sensor wires. When re-connecting the sensor, assure that the pairs (one is labelled 1) remain together as a pair. Reversing pairs of wire has no impact on the performance of the unit.

Terminal pairs	Resistance
1 and 2 (labelled 1)	90 to 180 Ω (275 Ω for TMH)
3 and 4	90 to 180 Ω (275 Ω for TMH)

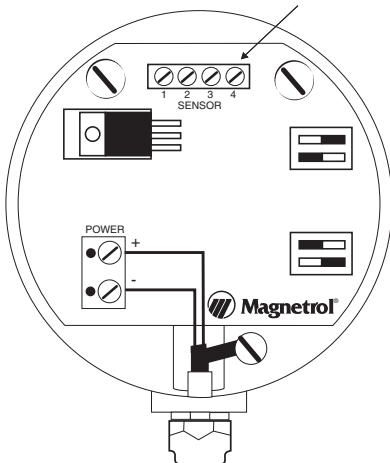

MAINTENANCE

Cleaning

The probe may be cleaned by soaking, spraying solvents or detergent and water onto the sensor tubes, or by ultrasonic cleaning. Lime deposits may be safely removed by soaking in 20 % hydrochloric acid. Warming to +65 °C (+150 °F) is permissible to speed this process.

For unusual cleaning problems, contact the factory and determine the exact materials of construction and chemical compatibility before using strong acids or unusual cleansers.

REPLACEMENT PARTS

NOTE: The switch will require recalibration (see page 5) following probe or electronics replacement.

Partn°:

T	G								
---	---	--	--	--	--	--	--	--	--

Serial n°:

--	--	--	--	--	--	--	--	--	--

Digit in partn°:

X	1	2	3	4	5	6	7	8	9	10
---	---	---	---	---	---	---	---	---	---	----

See nameplate, always provide complete partn° and serial n° when ordering spares.

↳ X = product with a specific customer requirement

EXPEDITE SHIP PLAN (ESP)

Several parts are available for quick shipment, within max. 1 week after factory receipt of purchase order, through the Expedite Ship Plan (ESP).

Parts covered by ESP service are conveniently grey coded in the selection tables.

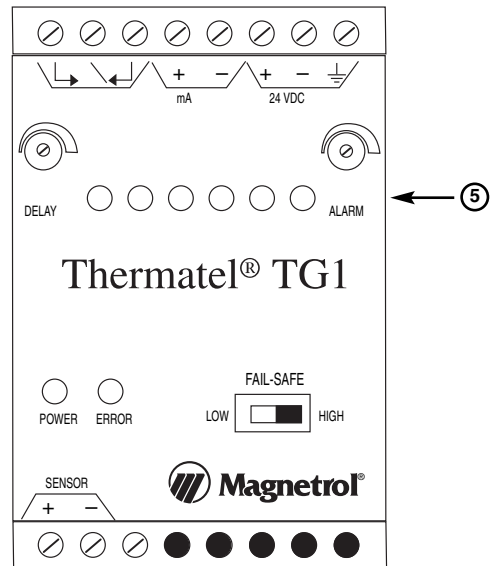
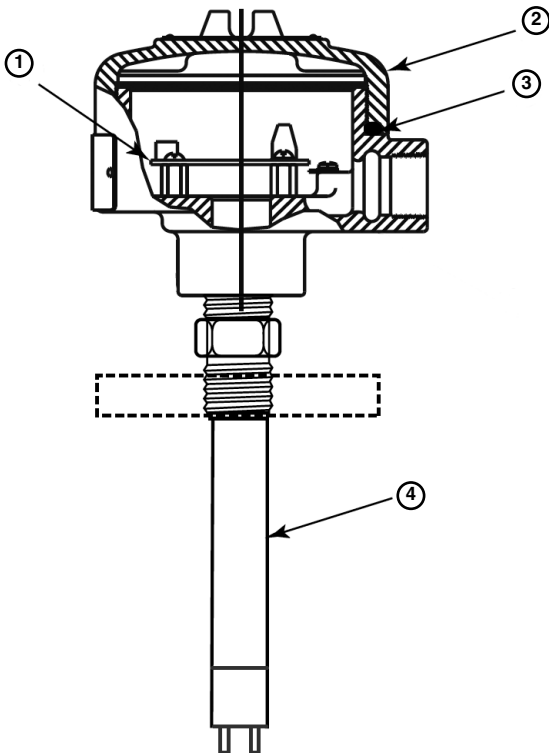

	Replacement part
(1) PC board	030-9114-001
(3) "O"-ring	012-2101-345
(4) Sensor	consult factory

(2) Housing cover	
Digit 8	Replacement part
2 or T	004-9105-001
6	004-9142-001

(5) DIN rail housing & electronics	
Digit 3	Replacement part
1	089-7905-001
2	089-7905-002

DIMENSIONS IN MM (INCHES)

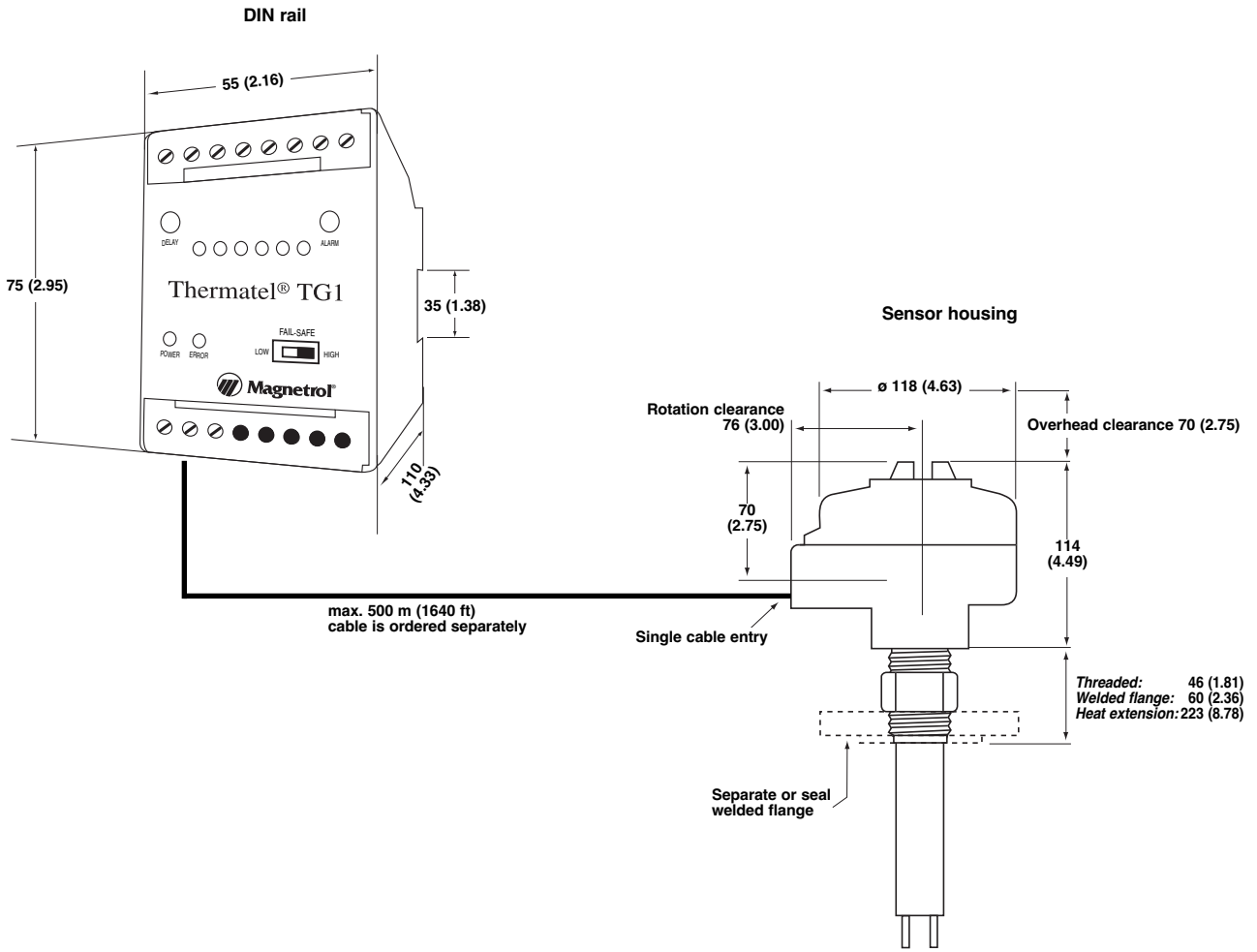

MODEL IDENTIFICATION

A complete measuring system consists of:

1. THERMATEL® DIN RAIL electronics and sensor housing
2. Connecting cable
3. THERMATEL® sensor
4. Optional: Order code for thread-on mounting flanges
5. Optional: Retractable probe assembly, consult factory for details
6. Optional: Factory calibration, consult factory

1. Code for Thermatel® DIN RAIL ELECTRONICS

T G 1	Electronics with standard LED flow indication
T G 2	Electronics with LED flow indication per NAMUR NE 44

OUTPUT

1	2 Amp SPDT alarm relay with mA output signal (non linear / non scaleable)
---	---------------------------------------------------------------------------

POWER SUPPLY

2	24 V DC
---	---------

MOUNTING

0 D	Remote DIN rail mounted electronics
-----	-------------------------------------

SENSOR HOUSING / CABLE ENTRY

T	IP 65, Cast aluminium, M20 x 1,5 cable entry
2	IP 65, Cast aluminium, 3/4" NPT cable entry
6	IP 65, Cast stainless steel, 3/4" NPT cable entry

APPROVAL

A 0	ATEX II 1 G EEx ia IIB T5, intrinsically safe
-----	-----------------------------------------------

T	G		
---	---	--	--

1	2	0	D
---	---	---	---

	A	0
--	---	---

complete code for Thermatel® TG1/TG2 electronics

X = product with a specific customer requirement

2. Code for connecting cable (standard 2-wire shielded instrument cable – 0,50 mm²)

0 0 1 - 5 0 0	From 1 m (3.28 ft) min. to 500 m (1640 ft) max. Specify in increments of 1 m (3.28 ft)
---------------	-------------------------------------------------------------------------------------------

1	3	7
---	---	---

3	2	2	2
---	---	---	---

--	--

complete code for connecting cable

CONNECTIONS

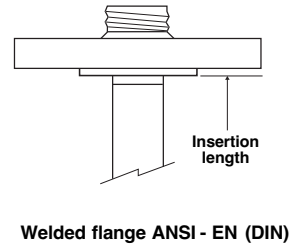
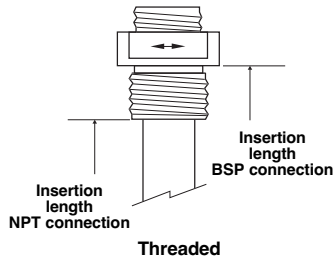

DIMENSIONS IN MM (INCHES) – TMA/TMB/TMC/TMD

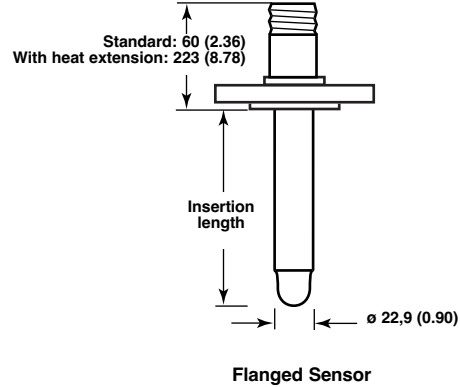
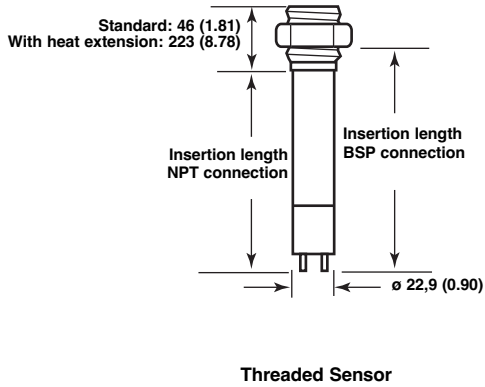

PRESSURE/TEMPERATURE RATING – TMA/TMB/TMC/TMD

Sensor	Material code	Insertion length	Maximum process pressure		
			@ +40 °C (+100 °F)	@ +120 °C (+250 °F)	@ +200 °C (+400 °F)
TMA, TMB	A	All	41,4 bar (600 psi)	33,8 bar (490 psi)	28,6 bar (415 psi)
TMC, TMD	A, D	= minimum length	207 bar (3000 psi)	170 bar (2460 psi)	148 bar (2140 psi)
		> minimum length	128 bar (1850 psi)	105 bar (1517 psi)	91,0 bar (1320 psi)
TMC, TMD	B	= minimum length	207 bar (3000 psi)	181 bar (2627 psi)	161 bar (2340 psi)
		> minimum length	103 bar (1500 psi)	90,6 bar (1313 psi)	80,7 bar (1170 psi)
TMC, TMD	C	= minimum length	172 bar (2500 psi)	147 bar (2125 psi)	137 bar (1980 psi)
		> minimum length	82,8 bar (1200 psi)	70,3 bar (1020 psi)	65,5 bar (950 psi)

TMA/TMB sensors

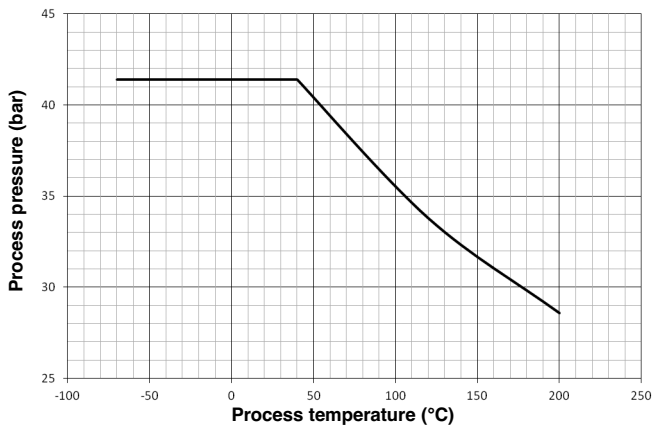

TMC/TMD sensors with material code A or D

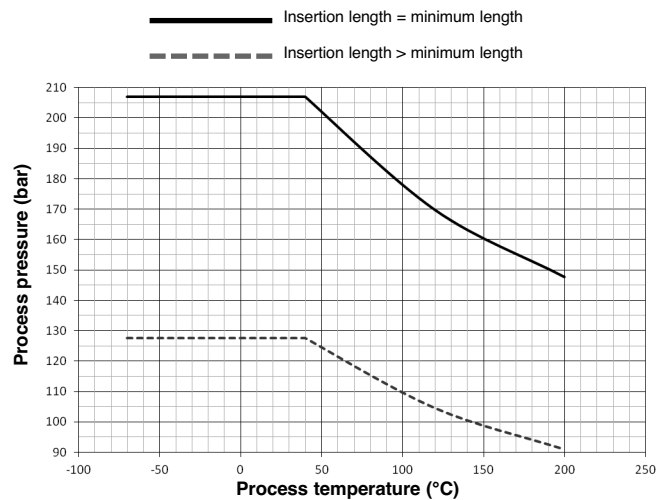

MODEL IDENTIFICATION

3. Code for Thermatel® TG1/TG2 – STANDARD SENSOR

T M A	Spherical tip - standard	max +120 °C (+250 °F)
T M B	Spherical tip - with heat extension	max +200 °C (+400 °F)
T M C	Twin tip - standard	max +120 °C (+250 °F)
T M D	Twin tip - with heat extension	max +200 °C (+400 °F)

MATERIAL OF CONSTRUCTION FOR SENSOR AND PROCESS CONNECTION

A	316/316L (1.4401/1.4404) stainless steel	
B	Hastelloy® C (2.4819)	- TMC/TMD only
C	Monel® (2.4360)	- TMC/TMD only

PROCESS CONNECTION – SIZE/TYPE Threaded

1 1 0	3/4" NPT
2 1 0	1" NPT
2 2 0	1" BSP (G 1")

ANSI flanges

2 3 0	1"	150 lbs ANSI RF
2 4 0	1"	300 lbs ANSI RF
2 5 0	1"	600 lbs ANSI RF
3 3 0	1 1/2"	150 lbs ANSI RF
3 4 0	1 1/2"	300 lbs ANSI RF
3 5 0	1 1/2"	600 lbs ANSI RF
4 3 0	2"	150 lbs ANSI RF
4 4 0	2"	300 lbs ANSI RF
4 5 0	2"	600 lbs ANSI RF

EN (DIN) flanges

B B 0	DN 25	PN 16/25/40	EN 1092-1	Type A
B C 0	DN 25	PN 63/100	EN 1092-1	Type B2
C B 0	DN 40	PN 16/25/40	EN 1092-1	Type A
C C 0	DN 40	PN 63/100	EN 1092-1	Type B2
D A 0	DN 50	PN 16	EN 1092-1	Type A
D B 0	DN 50	PN 25/40	EN 1092-1	Type A
D D 0	DN 50	PN 63	EN 1092-1	Type B2
D E 0	DN 50	PN 100	EN 1092-1	Type B2

INSERTION LENGTH – MINIMUM

		Sensor	Process connection
0 0 5	5 cm (2")	TMA, TMB	NPT
0 0 6	5,5 cm (2.17")		flanged
0 0 7	7 cm (2.76")		BSP
0 0 6	5,5 cm (2.17")	TMC, TMD	NPT, flanged
0 0 8	7,5 cm (3")		BSP

INSERTION LENGTH – SELECTABLE – Specify per cm (0.39") increment

		Sensor	Process connection
0 0 6	Minimum 6 cm (2.36")	TMA, TMB	NPT
0 0 7	Minimum 7 cm (2.76")		flanged
0 0 8	Minimum 8 cm (3.15")		BSP
0 0 7	Minimum 7 cm (2.76")	TMC, TMD	NPT, flanged
0 0 9	Minimum 9 cm (3.54")		BSP
3 3 0	Maximum 330 cm (130")	all	all

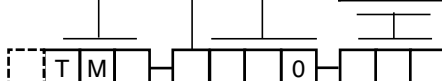

complete code for Thermatel® TG1/TG2 STANDARD SENSOR

→ X = product with a specific customer requirement

DIMENSIONS IN MM (INCHES) – HYGIENIC TMA/TMB

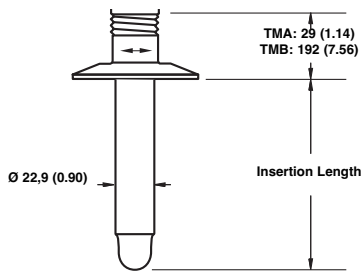

Tri-Clamp®

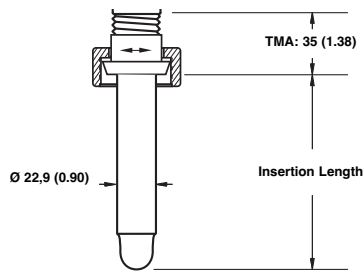

DIN 11851

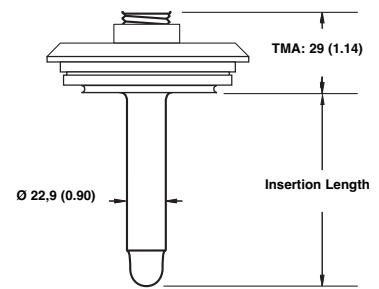

Varivent®

PRESSURE/TEMPERATURE RATING – HYGIENIC TMA/TMB

Note: max. process pressure is downrated to the design pressure of the selected process connection.

Maximum process pressure		
@ +40 °C (+100 °F)	@ +120 °C (+250 °F)	@ +200 °C (+400 °F)
41,4 bar (600 psi)	33,8 bar (490 psi)	28,6 bar (415 psi)

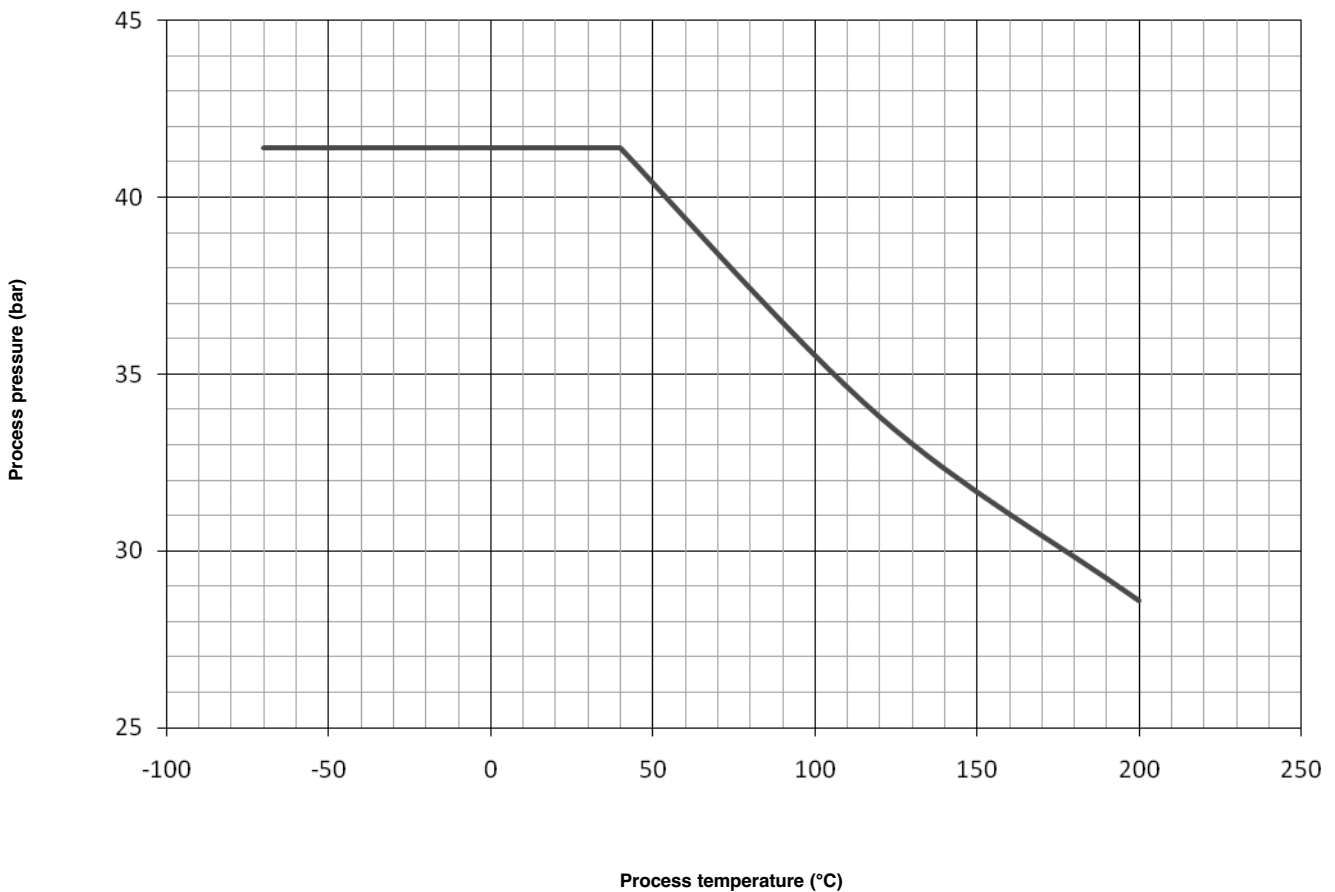

MODEL IDENTIFICATION

3. Code for Thermatel® TG1/TG2 – HYGIENIC SENSOR

T M A	Spherical tip - standard	max +120 °C (+250 °F)
T M B	Spherical tip - with heat extension	max +200 °C (+400 °F)

SENSOR MATERIAL (0,82 Mm Ra (32 Ra) surface finish)

A	316/316L (1.4401/1.4404) stainless steel
---	------------------------------------------

PROCESS CONNECTION – SIZE/TYPE ①

3 T 0	1 1/2" Tri-Clamp®
4 T 0	2" Tri-Clamp®
B S 0	DN 25 DIN 11851 - only available with TMA
C S 0	DN 40 DIN 11851 - only available with TMA
D S 0	DN 50 DIN 11851 - only available with TMA
V V 0	DN 65 Varivent® type N - only available with TMA

① Consult factory for other process connections (NEUMO BioControl®, G1A, ...)

INSERTION LENGTH – Specify per cm (0.39") increment

0 0 7	Minimum 7 cm (2.76")
3 3 0	Maximum 330 cm (130")

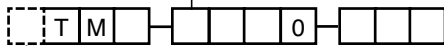

complete code for Thermatel® TG1/TG2 HYGIENIC SENSOR

➔ X = product with a specific customer requirement

DIMENSIONS IN MM (INCHES) – TMH



PRESSURE/TEMPERATURE RATING – TMH

Maximum process pressure			
@ +40 °C (+100 °F)	@ +120 °C (+250 °F)	@ +200 °C (+400 °F)	@ +450 °C (+850 °F)
414 bar (6000 psi)	339 bar (4920 psi)	295 bar (4280 psi)	233 bar (3380 psi)

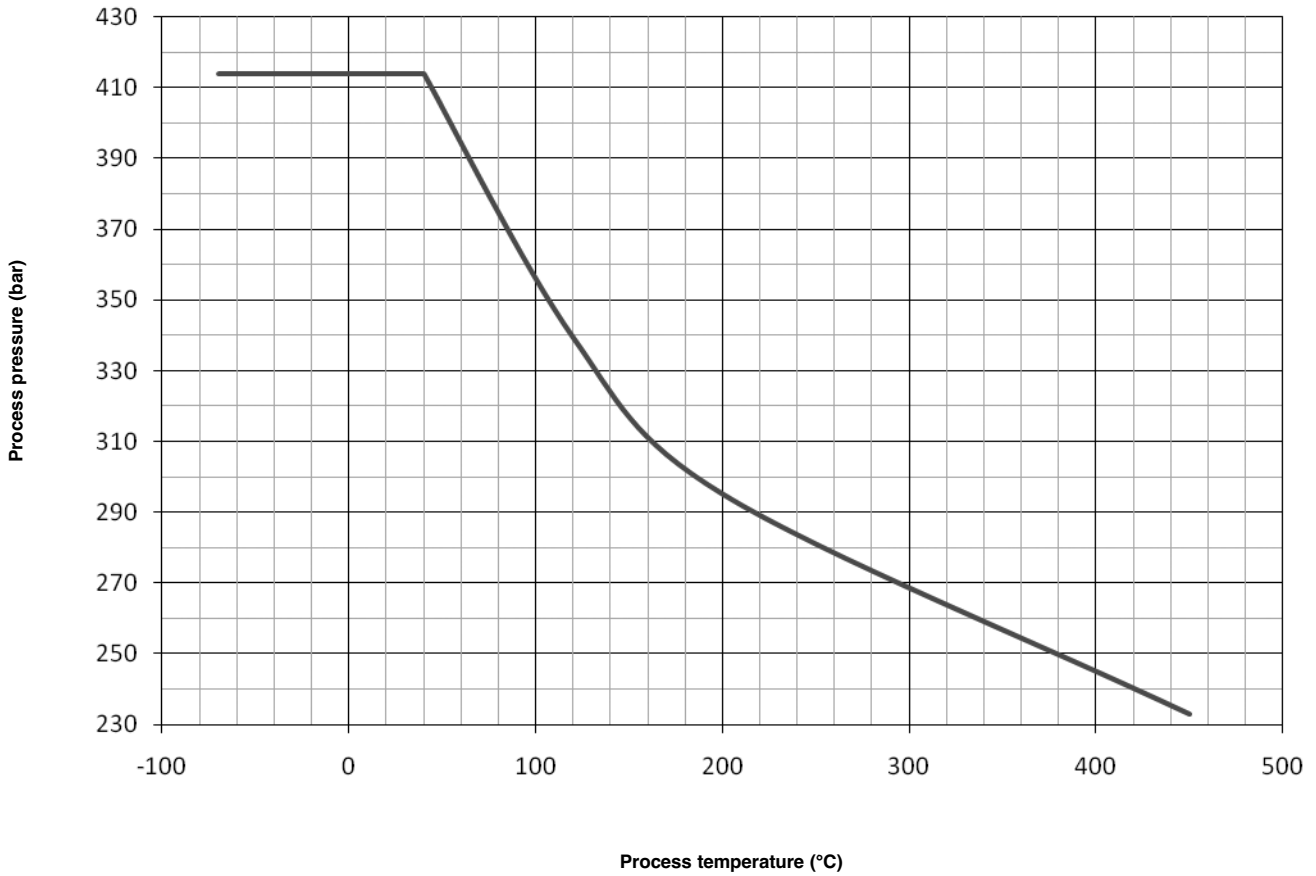

MODEL IDENTIFICATION

3. Code for Thermatel® TG1/TG2 – HIGH TEMPERATURE / HIGH PRESSURE SENSOR

T M H	High temperature / high pressure twin tip – max +450 °C (+850 °F) / max 414 bar (6000 psi) ^①
-------	---------------------------------------------------------------------------------------------------------

^① Not available with retractable probe assembly.

MATERIAL OF CONSTRUCTION FOR SENSOR AND PROCESS CONNECTION

A	316/316L (1.4401/1.4404) stainless steel
B	Hastelloy® C (2.4819)

PROCESS CONNECTION – SIZE/TYPE

Threaded

1	1	0	3/4" NPT
2	1	0	1" NPT
2	2	0	1" BSP (G 1")

ANSI flanges

2	3	0	1"	150 lbs	ANSI RF
2	4	0	1"	300 lbs	ANSI RF
2	5	0	1"	600 lbs	ANSI RF
2	7	0	1"	900/1500 lbs	ANSI RF
3	3	0	1 1/2"	150 lbs	ANSI RF
3	4	0	1 1/2"	300 lbs	ANSI RF
3	5	0	1 1/2"	600 lbs	ANSI RF
3	7	0	1 1/2"	900/1500 lbs	ANSI RF
3	8	0	1 1/2"	2500 lbs	ANSI RF
4	3	0	2"	150 lbs	ANSI RF
4	4	0	2"	300 lbs	ANSI RF
4	5	0	2"	600 lbs	ANSI RF
4	7	0	2"	900/1500 lbs	ANSI RF
4	8	0	2"	2500 lbs	ANSI RF

EN (DIN) flanges

B	B	0	DN 25	PN 16/25/40	EN 1092-1 Type A
B	C	0	DN 25	PN 63/100	EN 1092-1 Type B2
B	G	0	DN 25	PN 250	EN 1092-1 Type B2
C	B	0	DN 40	PN 16/25/40	EN 1092-1 Type A
C	C	0	DN 40	PN 63/100	EN 1092-1 Type B2
C	G	0	DN 40	PN 250	EN 1092-1 Type B2
C	J	0	DN 40	PN 400	EN 1092-1 Type B2
D	A	0	DN 50	PN 16	EN 1092-1 Type A
D	B	0	DN 50	PN 25/40	EN 1092-1 Type A
D	D	0	DN 50	PN 63	EN 1092-1 Type B2
D	E	0	DN 50	PN 100	EN 1092-1 Type B2
D	G	0	DN 50	PN 250	EN 1092-1 Type B2
D	J	0	DN 50	PN 400	EN 1092-1 Type B2

INSERTION LENGTH – MINIMUM

		Process connection		
0	0	6	5,5 cm (2.17")	NPT
0	0	7	7 cm (2.76")	flanged
0	0	8	7,5 cm (3")	BSP

INSERTION LENGTH – SELECTABLE – Specify per cm (0.39") increment

		Process connection		
0	0	7	Minimum 7 cm (2.76")	NPT
0	0	8	Minimum 8 cm (3.15")	flanged
0	0	9	Minimum 9 cm (3.54")	BSP
0	9	1	Maximum 91 cm (36")	all



**complete code for Thermatel® TG1/TG2
HIGH TEMPERATURE /HIGH PRESSURE SENSOR**

→ X = product with a specific customer requirement

MODEL IDENTIFICATION

3. Code for Thermatel® TG1/TG2 – MINI SENSOR

T M M	Mini twin tip – max +120 °C (+250 °F)
-------	---------------------------------------

MATERIAL OF CONSTRUCTION FOR SENSOR AND PROCESS CONNECTION

A	316/316L (1.4401/1.4404) stainless steel
---	------------------------------------------

PROCESS CONNECTION – SIZE/TYPE

Threaded

0 1 0	1/2" NPT
1 1 0	3/4" NPT
2 1 0	1" NPT

INSERTION LENGTH – MINIMUM

0 0 3	2,5 cm (1")
-------	-------------

INSERTION LENGTH – SELECTABLE – Specify per cm (0.39") increment

0 0 5	Minimum 5 cm (2")
3 3 0	Maximum 330 cm (130")

T M M A 1 0 **complete code for Thermatel® TG1/TG2 MINI SENSOR**

X = product with a specific customer requirement

DIMENSIONS IN MM (INCHES) & PRESSURE/TEMPERATURE RATING – TMM

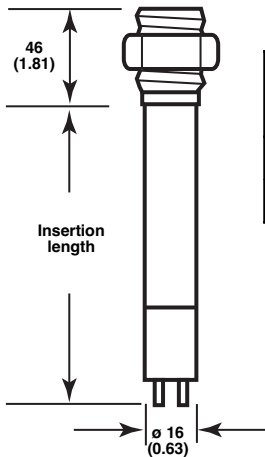

Insertion length	Maximum process pressure	
	@ +40 °C (+100 °F)	@ +120 °C (+250 °F)
= 2,5 cm (1")	207 bar (3000 psi)	170 bar (2460 psi)
> 2,5 cm (1")	128 bar (1850 psi)	105 bar (1517 psi)

— Insertion length = minimum length
 - - - - - Insertion length > minimum length

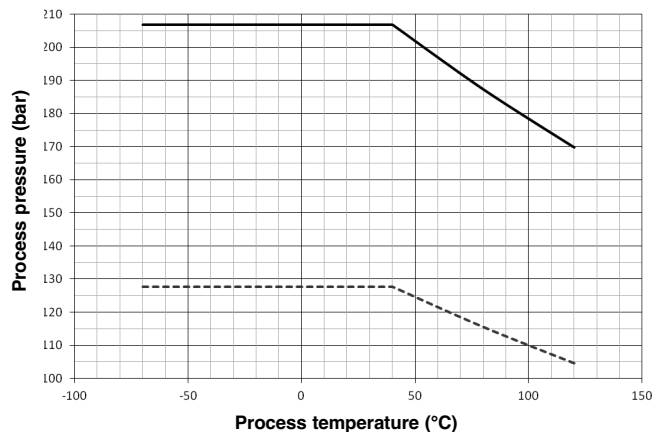

RECOMMENDED FLOW RANGES – TMM

Pipe size	Water	Air
1/2"	0,75 to 680 l/h (0.2 to 180 GPH)	0,85 to 120 Nm ³ /h (0.5 to 70 SCFM)
3/4"	2 to 900 l/h (0.5 to 240 GPH)	2,5 to 170 Nm ³ /h (1.5 to 100 SCFM)
1"	3,8 to 1600 l/h (1 to 420 GPH)	5 to 290 Nm ³ /h (3 to 170 SCFM)

MODEL IDENTIFICATION

3. Code for Thematel® TG1/TG2 – LOW FLOW BODY SENSOR

T M L	Low flow body – max +120 °C (+250 °F) / max 400 bar (5800 psi)
-------	----------------------------------------------------------------

MATERIAL OF CONSTRUCTION FOR SENSOR AND PROCESS CONNECTION

A	316/316L (1.4401/1.4404) stainless steel
---	------------------------------------------

PROCESS CONNECTION – SIZE/TYPE

Threaded

T	1	0	1/4" NPT-F
V	1	0	1/2" NPT-F
T	0	0	1/4" BSP (G 1/4")
V	0	0	1/2" BSP (G 1/2")

MOUNTING BRACKET

0	0	0	None
1	0	0	With carbon steel mounting bracket

T	M	L	A	0	0	0
---	---	---	---	---	---	---

complete code for Thematel® TG1/TG2 LOW FLOW BODY SENSOR

X = product with a specific customer requirement

DIMENSIONS IN MM (INCHES) & PRESSURE/TEMPERATURE RATING – TML

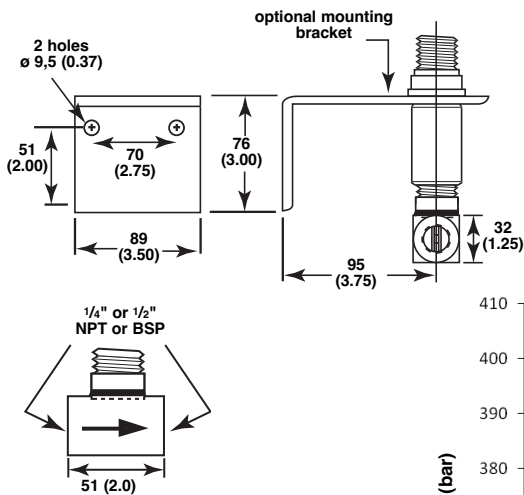

Maximum process pressure	
@ +40 °C (+100 °F)	@ +120 °C (+250 °F)
400 bar (5800 psi)	328 bar (4760 psi)

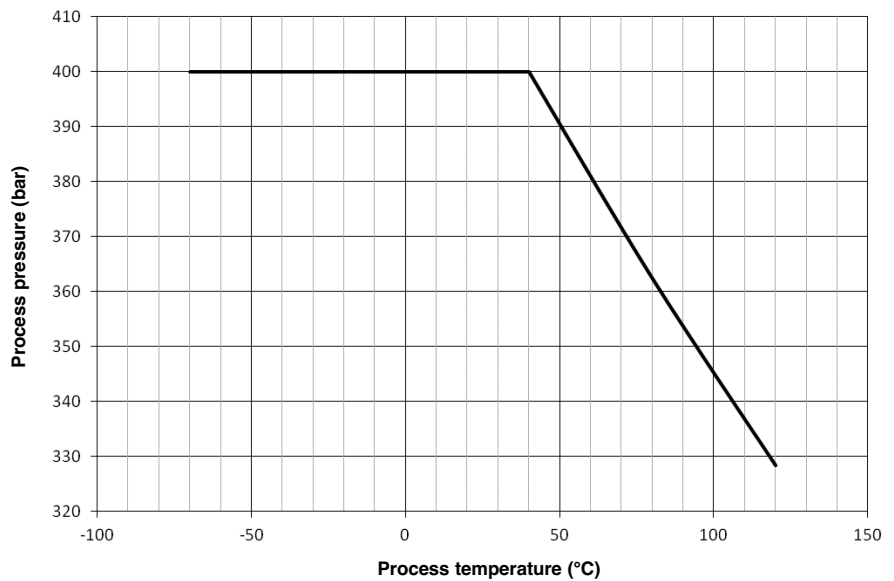

RECOMMENDED FLOW RANGES – TML

Size	Water	Air
1/4" flow body	0,02 to 5,7 l/h (0.0055 to 1.5 GPH)	0,006 to 5,75 Nm³/h (0.21 to 200 SCFH)
1/2" flow body	0,04 to 11,5 l/h (0.01 to 3 GPH)	0,015 to 11,5 Nm³/h (0.53 to 400 SCFH)

MODEL IDENTIFICATION

4. Optional sensor mounting flanges

Thread-on mounting flanges can only be used in combination with 3/4" NPT process connection sensor. Consult factory for other sizes or materials.

Thread-on flanges for use with 3/4" NPT-M connections

ANSI B16.5 flanges		Part No.		
		Carbon steel	316/316L SST	Hastelloy C
1"	150 lbs RF	004-5867-041	004-5867-043	004-5867-052
1 1/2"	150 lbs RF	004-5867-021	004-5867-001	004-5867-031
2"	150 lbs RF	004-5867-022	004-5867-002	004-5867-032
3"	150 lbs RF	004-5867-023	004-5867-003	004-5867-033
4"	150 lbs RF	004-5867-024	004-5867-004	004-5867-034
6"	150 lbs RF	004-5867-025	004-5867-005	004-5867-035
1"	300 lbs RF	004-5867-042	004-5867-044	004-5867-053
1 1/2"	300 lbs RF	004-5867-026	004-5867-006	004-5867-036
2"	300 lbs RF	004-5867-027	004-5867-007	004-5867-037
3"	300 lbs RF	004-5867-028	004-5867-008	004-5867-038
4"	300 lbs RF	004-5867-029	004-5867-009	004-5867-039
6"	300 lbs RF	004-5867-030	004-5867-010	004-5867-040
1"	600 lbs RF	004-5867-051	004-5867-050	004-5867-054
1 1/2"	600 lbs RF	004-5867-046	004-5867-045	004-5867-055
2"	600 lbs RF	004-5867-049	004-5867-048	004-5867-056

ELECTRONICS SPECIFICATIONS

Description		Specifications
Power supply		19,2 to 28,8 V DC
Power consumption		5 W max.
Flow range		TMA-A, TMB-A, TMC-A, TMD-A, TMM: 0,003 to 1,5 m/s (0.01 to 5.0 FPS) – water 0,03 to 150 m/s (0.1 to 500 FPS) – air
		TMM: see table on page 16
		TMC-B, TMC-C, TMD-B, TMD-C, TMH: 0,003 to 0,3 m/s (0.01 to 1.0 FPS) – water 0,03 to 150 m/s (0.1 to 500 FPS) – air
		TML: see table on page 17
Output	Alarm	2 A SPDT relay
	Continuous	mA output (non linear, non scaleable)
	Error	3,6 mA (Low Level Fail-Safe) – 22 mA (High Level Fail-safe)
User interface	Set point	Adjustable via potentiometer located on DIN Rail housing
	Range selection	Selectable in probe electronics
LED indication	Power	LED's for Power/Alarm status
	Error	Red LED blinks in case of error
	Alarm	4 x green LED's – for safe/ (normal) condition 1 x yellow LED – indicates when flow or level is approaching the alarm set point 1 x red LED – indicates an alarm condition (TG1) all LED's OFF – indicates an alarm condition (TG2)
Approvals		ATEX II 1 G EEx ia IIB T5 Other approvals are available, consult factory for more details
SIL (Safety Integrity Level)		Functional safety to SIL1 as 1oo1 / SIL2 as 1oo2 in accordance to IEC 61508 – SFF of 79,4 % – full FMEDA reports and declaration sheets available
Housing material		DIN Rail: IP 20, polycarbonate / Sensor housing: IP 65, Aluminium or Stainless Steel
Net weight		Aluminium: 1,6 kg (3.5 lbs) – electronics only Stainless steel: 4,0 kg (8.8 lbs) – electronics only

PERFORMANCE

<i>Description</i>	<i>Specification</i>
Response time	1-10 s typical (dependent on sensor type, application and set point)
Repeatability	< 1 % @ constant temperature
Ambient temperature	-40 °C to +70 °C (-40 °F to +160 °F) Storage: -50 °C to +75 °C (-58 °F to +170 °F)
Humidity	0-99 %, non-condensing
Electromagnetic compatibility	Meets CE requirements (EN 61326: 1997 + A1 + A2)

SENSOR SPECIFICATIONS

<i>Description</i>	<i>Spherical tip - Twin tip sensors INDUSTRIAL TMA/TMB - TMC/TMD</i>	<i>HTHP sensor TMH</i>
Materials	316/316L (1.4401/1.4404) Hastelloy® C (2.4819) – TMC/TMD only Monel® (2.4360) – TMC/TMD only	316/316L (1.4401/1.4404) Hastelloy® C (2.4819)
Sensor diameter	22,9 mm (0.90")	21,9 mm (0.86")
Process connection	Threaded: NPT or BSP Flanged: various ANSI or EN (DIN) flanges	
Sensor length	5 - 330 cm (2" - 130")	5,5 - 91 cm (2.17" - 36")
Process temperature	TMA/TMC: -70 °C to +120 °C (-100 °F to +250 °F) TMB/TMD: -70 °C to +200 °C (-100 °F to +400 °F)	-70 °C to +450 °C (-100 °F to +850 °F)
Max process pressure	See info on page 10	See info on page 14

<i>Description</i>	<i>Mini twin tip sensor TMM</i>	<i>Low flow body TML</i>
Materials	316/316L (1.4401/1.4404)	
Sensor diameter	16 mm (0.63")	1/4" or 1/2" pipe size
Process connection	Threaded: 1/2", 3/4" or 1" NPT	Threaded: 1/4" or 1/2" NPT-F or BSP
Sensor length	2,5 - 330 cm (1" - 130")	Not applicable
Process temperature	-70 °C to +120 °C (-100 °F to +250 °F)	
Max process pressure	See info on page 16	See info on page 17

<i>Description</i>	<i>Spherical tip sensors HYGIENIC TMA/TMB</i>
Materials	316/316L (1.4401/1.4404)
Surface finish	0,82 µm Ra (32 Ra)
Sensor diameter	22,9 mm (0.90")
Process connection	Tri-Clamp®, DIN 11851, Varivent®
Sensor length	7 - 330 cm (2.76" - 130")
Process temperature	TMA: -70 °C to +120 °C (-100 °F to +250 °F) TMB: -70 °C to +200 °C (-100 °F to +400 °F)
Max process pressure	See info on page 12

IMPORTANT

SERVICE POLICY

Owners of Magnetrol products may request the return of a control; or, any part of a control for complete rebuilding or replacement. They will be rebuilt or replaced promptly. Magnetrol International will repair or replace the control, at no cost to the purchaser, (or owner) **other than transportation cost** if:

- a. Returned within the warranty period; and,
- b. The factory inspection finds the cause of the malfunction to be defective material or workmanship.

If the trouble is the result of conditions beyond our control; or, is **NOT** covered by the warranty, there will be charges for labour and the parts required to rebuild or replace the equipment.

In some cases, it may be expedient to ship replacement parts; or, in extreme cases a complete new control, to replace the original equipment before it is returned. If this is desired, notify the factory of both the model and serial numbers of the control to be replaced. In such cases, credit for the materials returned, will be determined on the basis of the applicability of our warranty.

No claims for misapplication, labour, direct or consequential damage will be allowed.

RETURNED MATERIAL PROCEDURE

So that we may efficiently process any materials that are returned, it is essential that a "Return Material Authorisation" (RMA) form will be obtained from the factory. It is mandatory that this form will be attached to each material returned. This form is available through Magnetrol's local representative or by contacting the factory. Please supply the following information:

1. Purchaser Name
2. Description of Material
3. Serial Number and Ref Number
4. Desired Action
5. Reason for Return
6. Process details

Any unit that was used in a process must be properly cleaned in accordance with the proper health and safety standards applicable by the owner, before it is returned to the factory.

A material Safety Data Sheet (MSDS) must be attached at the outside of the transport crate or box.

All shipments returned to the factory must be by prepaid transportation. Magnetrol **will not accept** collect shipments.

All replacements will be shipped Ex Works.

UNDER RESERVE OF MODIFICATIONS

BULLETIN N°: BE 54-605.8
EFFECTIVE: AUGUST 2017
SUPERSEDES: December 2014



www.magnetrol.com

BENELUX FRANCE	Heikensstraat 6, 9240 Zele, België - Belgique Tel. +32 (0)52.45.11.11 • Fax. +32 (0)52.45.09.93 • E-Mail: info@magnetrol.be
DEUTSCHLAND	Alte Ziegelei 2-4, D-51491 Overath Tel. +49 (0)2204 / 9536-0 • Fax. +49 (0)2204 / 9536-53 • E-Mail: vertrieb@magnetrol.de
INDIA	B-506, Sagar Tech Plaza, Saki Naka Junction, Andheri (E), Mumbai - 400072 Tel. +91 22 2850 7903 • Fax. +91 22 2850 7904 • E-Mail: info@magnetrolindia.com
ITALIA	Via Arese 12, I-20159 Milano Tel. +39 02 607.22.98 • Fax. +39 02 668.66.52 • E-Mail: mit.gen@magnetrol.it
RUSSIA	Business center "Favater", Ruzovskaya Street 8B, office 400A, 190013 St. Petersburg Tel. +7 812 320 70 87 • E-Mail: info@magnetrol.ru
U.A.E.	PO Box 261454 • JAFZA LIU FZS1 – BA03, Jebel Ali Tel. +971 4 880 63 45 • Fax +971 4 880 63 46 • E-Mail: info@magnetrol.ae
UNITED KINGDOM	Unit 1 Regent Business Centre, Jubilee Road Burgess Hill West Sussex RH 15 9TL Tel. +44 (0)1444 871313 • Fax +44 (0)1444 871317 • E-Mail: sales@magnetrol.co.uk