

A Higher Level of Performance



Manual

Sultan

Acoustic Wave Series

Level, Flow, Positioning, Collision Protection



For more information, please visit >

www.hawkmeasure.com



Table of Contents

Sultan Acoustic Wave Series



Contents

System Components	3	Average Level	28
Remote Amplifier	3	Differential Level	29
Panel Mount Remote Amplifier	3	Advanced Setup Menu	30
Flange and Cone Assembly	4	Advanced Parameters	31
AWR234 Remote Amplifier	4	Output Adjustment Setup Menu	32
Wiring The Unit	5	Output Adjustment Parameters	33
Sultan Remote Units	5	Relay Switch Actions	34
Sultan Integral Units	6	Relay 1 - 5	34
Sultan Panel Mount Units	7	Comm Types Setup Menu	35
Sultan SMART Units	8	Modbus	36
Wiring 4-20mA Output	9	DeviceNet - Setup & Parameters / Wiring	38
SOURCING Type Output	9	Profibus - Setup & Parameters	39
SINKING Type Output (also 2 wire loop powered)	9	PC Comms - GosHawkII	40
Junction Box / Transducer Cable Extension	9	Converting 234 Wire to 2 Wire Loop	41
Wiring Transducer for Anti Crosstalk	10	Troubleshooting	42
Wiring for Anti Crosstalk	10	Displays Distance	43
Digital Output Pulse Sequencing	11	Output	44
Incorrect Mounting	12	Unit Voltage Specs & Checks	45
Correct Mounting	13	Remote & Integral	45
Installation Guide	14	Troubleshooting	46
Installation Examples	16	Error Codes 01 - 04	46
Setting Your System	17	Technical Support	47
Dimensions	18	Part Numbering	48
Integral Units	18	Sultan Remote Transmitter	48
Remote Transducers	18	Sultan Remote Transducer 3" and 3.5"	49
Flanges	19	Sultan Remote Transducer 2" Version	50
Remote Amplifier	19	Sultan Integral 3" and 3.5"	51
Minimum Measurement Range	20	Sultan Integral 2"	52
Wiring Diagrams	21	Flange Selection	53
AWR Remote Transmitter	21	Cone Selection	53
AWI Integral Transmitter	21	Transducer / Cone / Flange Combination Table	54
Diagnostics & Software Overview	22	Accessories	54
Quickset Flow Chart	23	Specifications	55
Quickset Parameters	24	Specifications / Approvals & Certification	56
Quickset	24		
Application Types	25		
Display Mode	27		

System Components

Sultan Acoustic Wave Series



Remote Amplifier

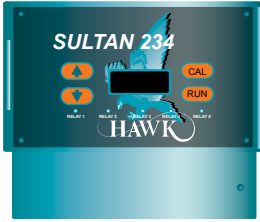

Panel Mount Remote Amplifier



10kHz Remote Transducer

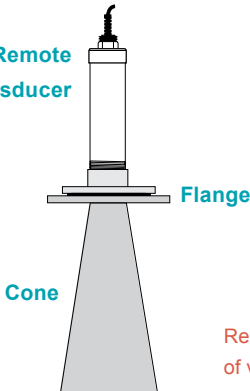

40kHz Remote Transducer



Remote systems consist of an amplifier and separate transducer of varying size & shape depending on frequency

50kHz SMART Unit

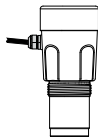

SMART & Integral units combine both the amplifier and transducer functions in a single housing

30kHz Integral Unit

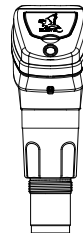

Flange and Cone Assembly

Sultan Acoustic Wave Series



AWR234 Remote Amplifier

1

Remove red cap (including cardboard).



Note! Direction of flange, smallest ring this way up ↑

2

Screw the flange assembly fully down onto the cone (as far down as it will go until the parts are tightly fastened).



3

Screw the transducer tightly down onto the flange and cone assembly.



4

Tighten the locking ring down to the flange to fix the components in place.



COMPLETE ASSEMBLY
(appearance above flange may differ for integral and smart units).



User mountings should only connect to the larger (lower) isolated mounting flange. No other part of the sensor assembly should touch any other structure or object.



Sultan Remote Units

The Sultan Remote amplifier has wiring information printed inside the flip lid of the unit.

Unscrew the lower flip lid to access the wiring terminals.

Ensure your power source is deactivated before handling power wires.

Pass cables through the cable entry gland before wiring into the terminal block.

To connect a wire, remove the required terminal block with pliers place the wire in firmly screw down the connection. The transducer terminals are labeled by colour on the PCB.

If you are connecting HawkLink communications, connect the blue wire to B and the white wire to A.

The black wire can be connected to the DC- or GND terminal next to A.

Tighten cable entry gland(s) and cover to ensure sealing is effective.

234 wire version

RELAY 1			RELAY 2			RELAY 3			RELAY 4			RELAY 5		
NC	COM	NO	NC	COM	NO	NC	COM	NO	NC	COM	NO	NC	COM	NO
<input type="checkbox"/>	<input type="checkbox"/>	<input type="checkbox"/>	<input type="checkbox"/>	<input type="checkbox"/>	<input type="checkbox"/>	<input type="checkbox"/>	<input type="checkbox"/>	<input type="checkbox"/>	<input type="checkbox"/>	<input type="checkbox"/>	<input type="checkbox"/>	<input type="checkbox"/>	<input type="checkbox"/>	<input type="checkbox"/>
16	17	18	19	20	21	22	23	24	25	26	27	28	29	30
<input type="checkbox"/>	<input type="checkbox"/>	<input type="checkbox"/>	<input type="checkbox"/>	<input type="checkbox"/>	<input type="checkbox"/>	<input type="checkbox"/>	<input type="checkbox"/>	<input type="checkbox"/>	<input type="checkbox"/>	<input type="checkbox"/>	<input type="checkbox"/>	<input type="checkbox"/>	<input type="checkbox"/>	<input type="checkbox"/>
1	2	3	4	5	6	7	8	9	10	11	12	13	14	15
Is	+	-	RED	BLACK	BLUE	WHITE	Test In	B	A	-	+	⊕	N	L1
4-20mA			TRANSDUCER					COMMS		DC-In		AC-In*		

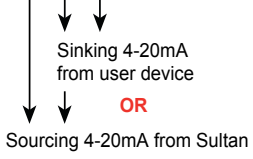

**AC-In is replaced by 36-60VDC with Power Input Option 'C'.*

2 wire version

Test In		COMMS		Shld	
<input type="checkbox"/>	<input type="checkbox"/>	A	B	<input type="checkbox"/>	<input type="checkbox"/>
<input type="checkbox"/>	<input type="checkbox"/>	<input type="checkbox"/>	<input type="checkbox"/>	<input type="checkbox"/>	<input type="checkbox"/>
7	8	9	10	11	12
<input type="checkbox"/>	<input type="checkbox"/>	<input type="checkbox"/>	<input type="checkbox"/>	<input type="checkbox"/>	<input type="checkbox"/>
1	2	3	4	5	6
RED	BLACK	BLUE	WHITE	+	-
TRANSDUCER				4-20mA	

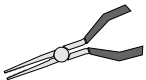
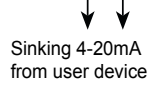

Use long nose pliers to extract terminals



Sultan Integral Units

The Sultan Integral unit has wiring information printed inside the flip lid of the unit.

Unscrew the lid to expose the facia.

The lid can be snapped back to allow easier access for wiring. When finished, first re-snap the double hinge into position before closing the lid. The top half of the facia is a flip cover which exposes the wiring terminals.

Ensure your power source is deactivated before handling power wires.

Pass cables through the cable entry gland before wiring into the terminal block.

To connect a wire, push down on the button above the terminal with a small flat head screwdriver and place the wire in the terminal. Release the pressure on the button to close the terminal and then pull on the wire to check that it is secure.

If you are connecting HawkLink communications, connect the blue wire to B and the white wire to A. The black wire should be connected to the Shld terminal.

Tighten cable entry gland(s) and cover to ensure sealing is effective.

234 wire version

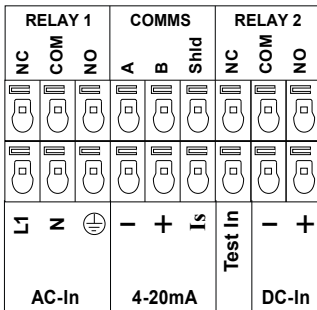

Sinking 4-20mA
from user device

OR

Sourcing 4-20mA
from Sultan

2 wire version

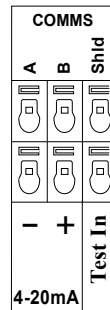

Sinking 4-20mA
from user device

Ensure that any unused cable gland entries are plugged or sealed.



Sultan Panel Mount Units

The Sultan Panel Mount has wiring information printed on the back of the unit.

Terminal blocks can be removed during installation to allow easier wire connection. Take care to return them to the correct position.

Ensure your power source is deactivated before handling power wires.

Ensure terminals are open by screwing counter clockwise with a flat head screwdriver. Place the exposed wires into the open terminals and tighten until firm.

The transducer terminals are labeled by colour on the back panel.

If you are connecting HawkLink communications, connect the blue wire to B and the white wire to A.

The black wire can be connected to the DC- or GND terminal next to A.

234 wire version

RELAY 1			RELAY 2			RELAY 3			RELAY 4			RELAY 5		
NC	COM	NO	NC	COM	NO	NC	COM	NO	NC	COM	NO	NC	COM	NO
N	L		+	-	A	B	Test In	RED	BLACK	BLUE	WHITE	-	+	Is
AC-In			DC-In			COMMS			TRANSDUCER			4-20mA		

Sinking 4-20mA
from user device

OR

Sourcing 4-20mA
from Sultan

2 wire version

N/C	N/C	N/C	N/C	I	A	B	Test In	RED	BLACK	BLUE	WHITE	-	+	N/C	
				COMMS				TRANSDUCER				4-20mA			

Sinking 4-20mA
from user device



Sultan SMART Units

The Sultan SMART unit has wiring information printed inside the lid of the unit.

Screw Cap Version

Unscrew the lid to expose the terminals. It is recommended you remove the terminal block from the unit before wiring - to do this, insert a screw driver into one of the middle terminals to lever the block out. Pass the cables through the cable entry gland before wiring in to the terminal block.

Ensure the terminal is open by screwing counter clockwise with a flat head screwdriver. Place the exposed wires into the open terminals and tighten until firm. Insert the block back into the unit when wiring is complete. Press firmly on the plug in terminal block to ensure it is fully home.

If you are connecting HawkLink communications, connect the blue wire to B and the white wire to A. The black wire can be connected to the DC- terminal next to B.

Tighten cable entry gland(s) and cover to ensure sealing is effective.

IP68 Sealed Cable Version

Connect the free ends of the cable following the wire colours as shown in the terminal diagrams.

AWSTA version

⊘	⊘	⊘	PURPLE	WHITE	BLUE	BLACK	⊘	⊘	GREEN	YELLOW
		Test In	A	B	I			-	+	
			COMMS					4-20mA		

↓ ↓
Sinking 4-20mA
from user device
(loop powered)

AWSTC version

⊘	⊘	⊘	⊘	⊘	⊘	⊘	⊘	⊘	⊘	⊘
BROWN	ORANGE	PURPLE	WHITE	BLUE	BLACK	RED				
COM	N/O	Test In	A	B	I	+				
RELAY			COMMS		DC In					

AWSTD version

⊘	⊘	⊘	⊘	⊘	⊘	⊘	⊘	⊘	⊘	⊘
BROWN	ORANGE	PURPLE	WHITE	BLUE	BLACK	RED	GREEN	YELLOW		
COM	N/O	Test In	A	B	I	+	-	+		
RELAY			COMMS		DC In		4-20mA			

↓ ↓
Sinking 4-20mA
from user device



When connecting the 4-20mA output to a user device such as a PLC input, DCS or indicator, use a voltmeter to check the field wires to be used for the 4-20mA signal. If DC voltage around 24V is present, use sinking connection. If no voltage is present, use sourcing connection.

SOURCING Type Output

Sultan output is sourcing current and provides voltage to drive a passive load, PLC input, indicator or other user device.

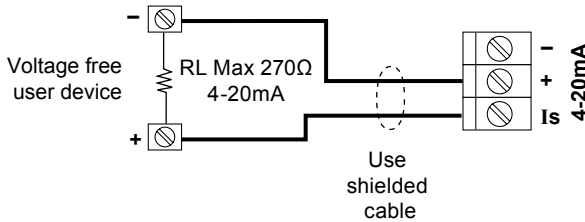

NOTE:
 Isolated current output can be made common with +DC or GND if required. (e.g. RL – connected to GND)

SINKING Type Output (also 2 wire loop powered)

Sultan output is sinking current. Voltage to drive current loop must be provided by PLC, indicator, other user device or external DC supply.

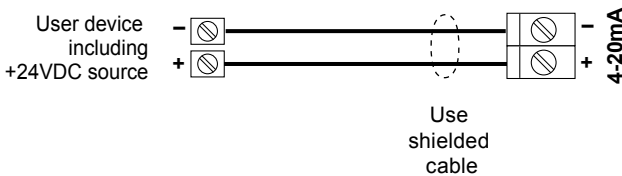

NOTE:
 RL Max = 750Ω if user DC Supply 24V.

Junction Box / Transducer Cable Extension

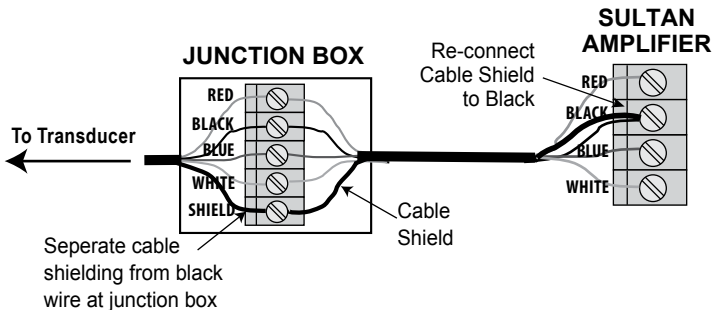

Wiring Transducer for Anti Crosstalk

Sultan Acoustic Wave Series



The term crosstalk is used to refer to interference between acoustic wave units of the same frequency located near one another. The units can 'hear' direct or reflected signals from one another. This can cause randomly false measurements and outputs whilst giving correct performance at other times.

Crosstalk is more likely to exist when there are multiple units in a small enclosed area with highly reflective surfaces and with fast moving applications.

Wiring for Anti Crosstalk

1. Link all units to a common ground, or parallel connect their 'GND' or 'DC-' terminals.
*GND and DC- terminals are electrically connected inside Sultan 234 units, so either one may be used.
2. At each individual unit, wire a connection between a Relay (eg Relay 1) 'Common' terminal and the 'TEST' terminal of the same amplifier.
3. Wire a connection between the chosen Relay 'Normally Open' terminals of all units to be linked (parallel connection of all units).
4. In the Output Adjust menu for each unit program the chosen Relay to 'FS' (Fail-safe) mode.
The units will now be linked so that they cannot crosstalk.
5. **(UPDATE MARCH 2012)**. New release software includes an additional menu in the 'Output Adjust' section called 'test input'. The option 'Synchronise' improves the cross talk sequencing for larger amounts of units.
HAWK does not recommend more than 6 transducers in a single anti cross talk circuit.

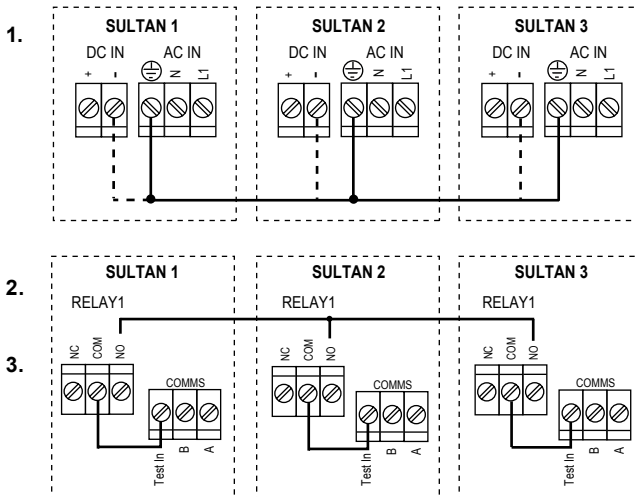

Digital Output Pulse Sequencing

Sultan Acoustic Wave Series



A PLC/DCS with digital outputs can be used to control or sequence pulse rates.

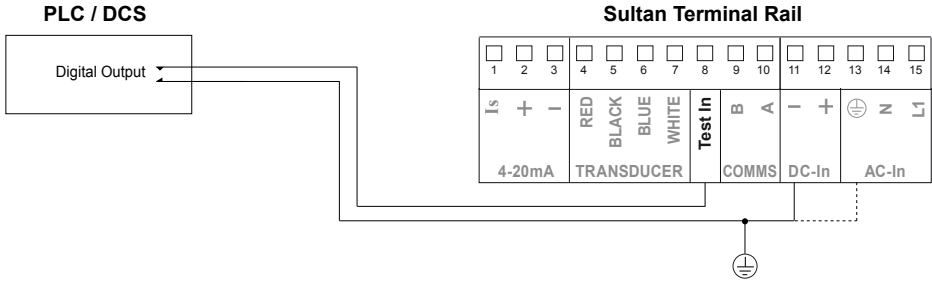

Sequence Timing

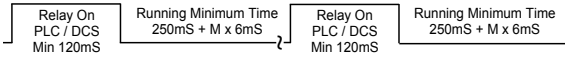

Incorrect Mounting

Sultan Acoustic Wave Series



These are examples of common **INCORRECT** mountings which can prevent the unit from operating correctly.

Do **NOT** mount near infeed

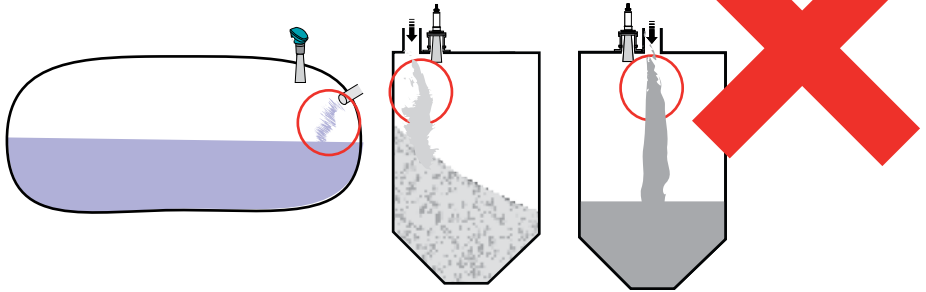

Do **NOT** mount over or adjacent to **any** obstacles

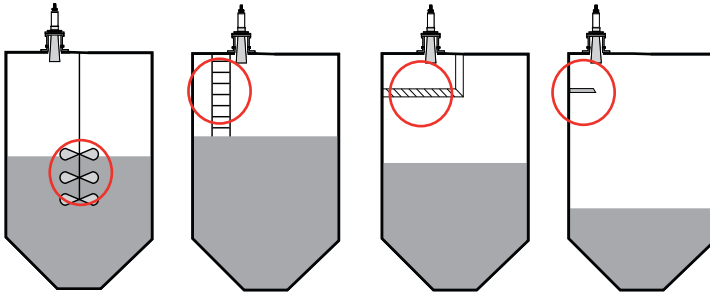

Do **NOT** mount cone or transducer face above roofline

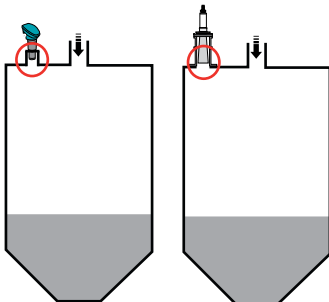

Do **NOT** mount on angle in liquid applications

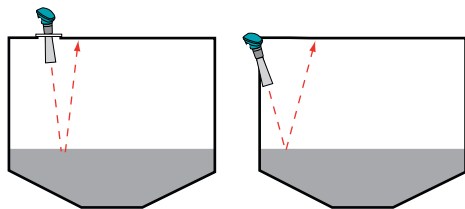

Correct Mounting

Sultan Acoustic Wave Series

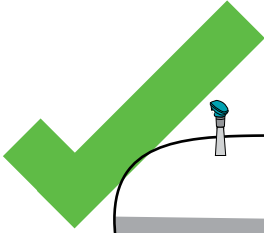

Mount away from infeed

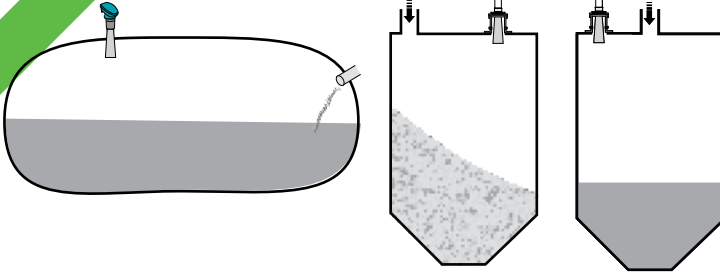

Mount away from all obstacles

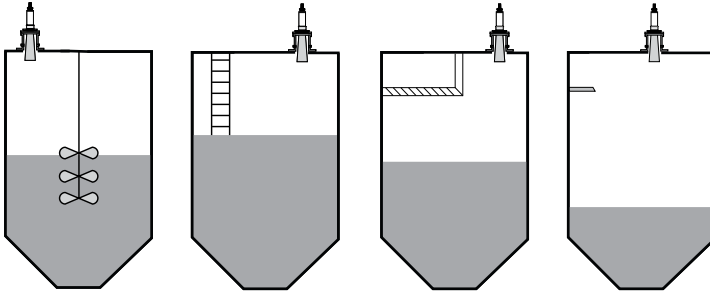

Mount cone / transducer face within the vessel

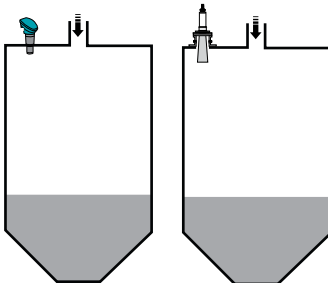

Mount perpendicular to liquids

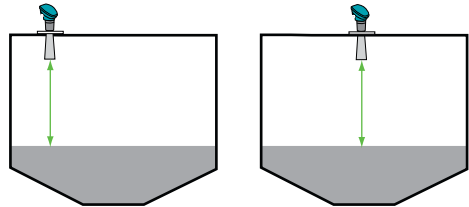



Amplifier

Select a suitable mounting position that is protected from direct sunlight. If necessary, utilize a sun hood (HAWK supplies purpose made sun hoods). Observe the minimum and maximum temperature limits (-20°C/-4°F to 60°C/140°F) Do not mount near sources of electrical noise such as high current cables, motor starters, or variable speed drives. Avoid mounting in high vibration areas such as handrails and rotating plant. Use rubber absorption mounts if mounting in light vibration areas. Protect the PCB assembly before knocking out the cable and conduit entry holes.

Panel Mount

- Select a suitable position within a panel layout which allows clearance around the outside of the front panel of the unit and also behind the panel for clearance around the screw fixing clamps used to retain the unit.
- Ensure that sufficient space is available behind the panel to accommodate the depth of the amplifier housing, and also allow cable bend clearance for wiring to the terminals on the rear of the amplifier.
- Mark and cut a 90x90mm (3.54x3.54") square cut out through the panel in the desired position.
- Insert the Sultan amplifier through the panel and install supplied screw clamps into the slotted holes in the amplifier housing.
- Tighten the screws until just firm to secure the amplifier in place.
- Connect wiring as required to the correct terminals on the removable rear panel connectors. When plugging connectors in to the rear panel, ensure that they are re-installed in the correct position.

Transducer

Selecting a suitable position to mount the transducer on the vessel is the single MOST IMPORTANT step. Please read all of the installation guide and contact your HAWK representative if you have any doubts or questions. The transducer face MUST be at least the blanking distance away from highest product level in the vessel.

Use common sense when selecting the transducer mounting position. **A clear line of sight from the transducer to the product being monitored is required.**

Take into account the change in material shape and level. The acoustic pulse must reflect back to the transducer.

Incorrect Mounting

Failure to mount the unit suitably can result in incorrect measurement and may cause process issues such as overfilling or damage to critical components.

Process Conditions

Ensure the process conditions within the vessel such as temperature, pressure and chemical composition of contents are within the specifications Sultan unit. The unit should not normally come into contact with the measured content.



Minimum Insertion

The transducer face or cone must be at least 50mm (2 inches) inside the tank.

If the transducer needs to be mounted above the roof line, use an appropriate standpipe or nozzle.

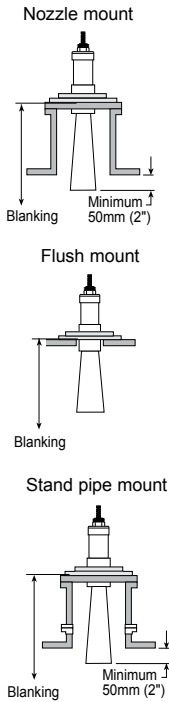

Moisture Seal

Sultan Integral and Smart units have cable glands with a moisture seal which must be tightened around the cable. Any unused glands must be plugged and sealed.

Transducer Location

It is vital that the Transducer has a clear view of the product surface at all times and is kept **away from the inflow** to avoid interference.

Blanking Distance

The unit will ignore any echoes and will never measure within its Blanking distance.

Minimum values must be respected. Where possible use the conservative values and increase this distance by 50% if there is foam, dust, steam, or condensation in the vessel being monitored.

(Refer to Blanking Distance table.)

If using a flange mounting, use a rubber or neoprene gasket and washers. If using a nipple mounting, ensure that the mounting bracket is **>6mm (0.24 in) from the rear** of the transducer. Do not over tighten the lock nuts.

Blanking Distance		Minimum	Nominal	Conservative
Transducer Frequency				
AWRT50	50kHz	0.25m (10")	0.3m (1ft)	0.35m (1.2ft)
AWRT40	40kHz	0.3m (1.1ft)	0.35m (1.2ft)	0.4m (1.4ft)
AWRT30	40kHz	0.35m (1.5ft)	0.4m (1ft)	0.5m (2.2ft)
AWRT20	20kHz	0.5m (2.2ft)	0.6m (1.3ft)	0.8m (2.6ft)
AWRT10	10kHz	1.0m (3.3ft)	1.1m (3.5ft)	1.3m (4.2ft)
AWRT5	5kHz	1.2m (3.9ft)	1.4m (4.6ft)	1.5m (5ft)

Always use conservative nominated distances if possible.

Installation Examples

Sultan Acoustic Wave Series



SOLID (Granular)



Aim transducer at point of outfeed.

LIQUID

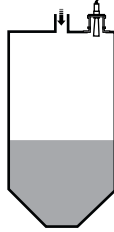

Transducer should vertical

DUAL OUTFEED



Two transducers may require anti-crosstalk wiring setup (see manual)

POWDER

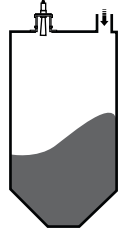

Mount away from infeed

MOUNTING POSITION

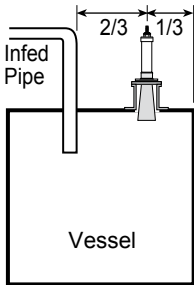

NOZZLE MOUNT

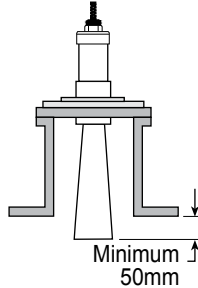

FLUSH MOUNT

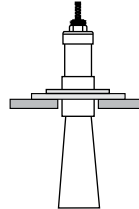

STAND PIPE MOUNT

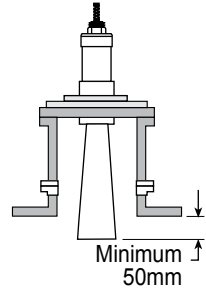

2" VERSION

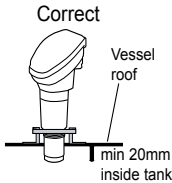

Threaded mounting should only be used where a flange/cone mounting is impossible. Hawk recommends & supplies focaliser cones for all transducers.

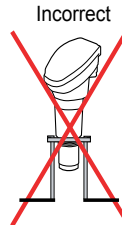
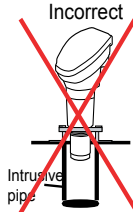

Face must not be inside mounting

Setting Your System

Sultan Acoustic Wave Series



After the unit has been installed, mounted and powered you can now enter the Quickstart settings to get the unit operational in your application conditions.

Be sure to enter settings for High & Low level, App Type, Fill Rate and Empty Rate of your vessel.

If you are unsure of your specific fill & empty speed enter a value you are sure is faster than your process.

All of the mentioned settings (except Blanking) are in the 'Quickset' menu of the unit. You access this menu on the control pad by pressing CAL and entering Unlock code 0.

You may also need to set relay switch points. These are found in 'Output Adjustment'. Relay alarms can be set on/off for hi/lo levels and failsafe.

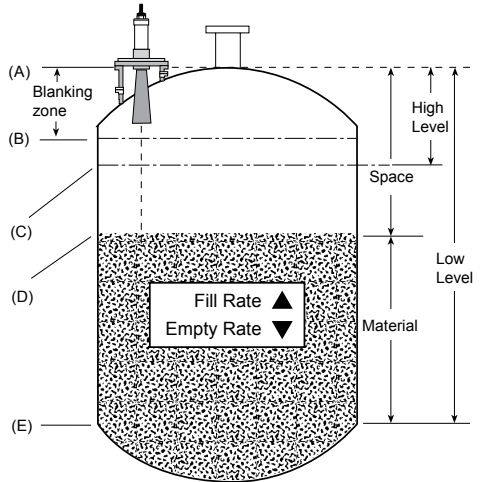

- (A) Transducer Face - Top of Flange
- (B) End of Blanking Zone
- (C) High Level or 100% (20mA) position.
- (D) Product Level being measured
- (E) Low Level or 0% (4mA) position.

High Level = Distance A to C
Low Level = Distance A to E

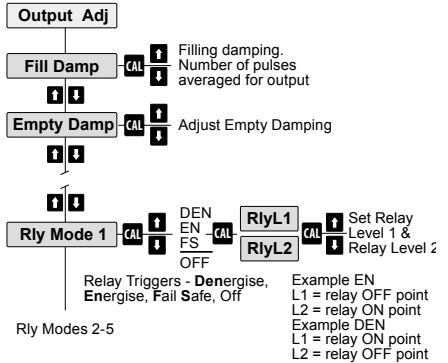
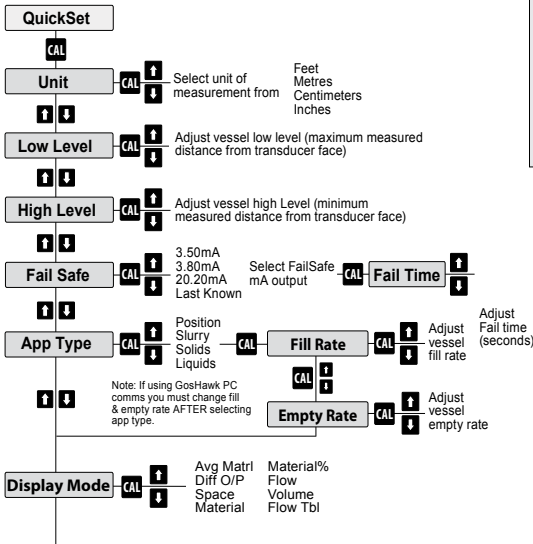

Dimensions

Sultan Acoustic Wave Series



Integral Units

Standard Type

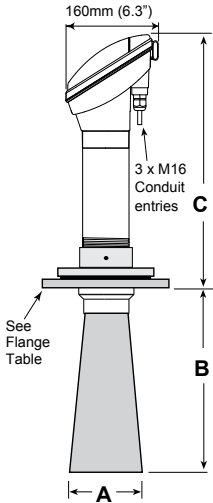

Compact Type (2" BSP / NPT)

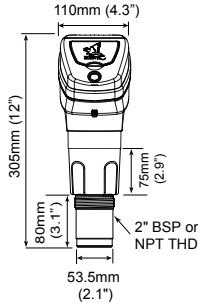

Remote Transducers

Standard Type

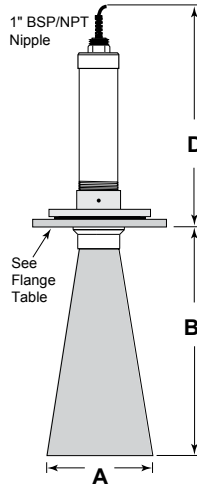

Compact Type (2" BSP / NPT)

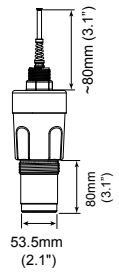

All cones must protrude into the main volume of the vessel by at least 50 mm (2 inches) past the lower end of the mounting nozzle.

Cone / Transducer Dimensions Table

Sensor Frequency	Selected Flange	A		B		C		D	
		mm	in.	mm	in.	mm	in.	mm	in.
5 kHz	10"	236	10.0	455	17.9	840	33.1	750	29.5
	8"	195	8.0	280	11.1	540	21.3	450	17.7
10 kHz	10"	236	10.0	455	17.9	540	21.3	450	17.7
	8"	195	8.0	280	11.0	440	17.3	350	13.8
15 kHz	10"	236	10.0	455	17.9	390	15.4	300	11.8
	8"	195	8.0	280	11.0	350	13.8	260	10.2
20 / 30 kHz	4"	98.5	4.0	280	11.0	350	13.8	260	10.2
30 / 40 / 50 kHz	4"	98.5	4.0	280	11.0	350	13.8	260	10.2



Flanges

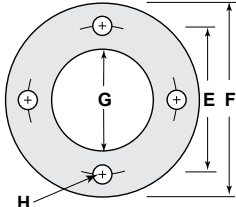

FLANGE TYPE:
 A = ANSI Flange
 J = JIS Flange
 D = DIN Flange

Standard ANSI/DN/JIS Flange Dimensions

Size	Flange Type	E (PCD)		F (OD)		G (ID)		H (Hole)		No. Holes
		mm	in.	mm	in.	mm	in.	mm	in.	
4"	FA4 ANSI class 150	190.5	7.5	229	9.0	100	4	19	0.75	8
	FD4 DIN100 PN10/16	180	7.1	220	8.7	100	4	18	0.71	8
	FJ4 JIS B2220-1984 10kg	175	6.9	210	8.4	100	4	19	0.75	8
6"	FA6 ANSI class 150	241.5	9.5	279	11.0	150	6	22	0.87	8
	FD6 DIN150 PN10	240	9.4	285	11.2	150	6	23	0.91	8
	FJ6 JIS B2220-1984 10kg	240	9.4	280	11.0	150	6	23	0.91	8
8"	FA8 ANSI class 150	298.5	11.8	343	13.5	200	8	22	0.85	8
	FD8 DIN200 PN10	295	11.6	340	13.4	200	8	22	0.85	8
	FJ8 JIS B2220-1984 10kg	290	11.4	330	13.0	200	8	19	0.91	12
10"	FA10 ANSI class 150	362	14.3	406	16.0	250	10	25	1.02	12
	FD10 DIN200 PN10	350	13.7	395	16.0	250	10	23	0.85	12
	FJ10 JIS B2220-1984 10kg	355	14.0	400	15.7	250	10	25	0.99	12

Remote Amplifier

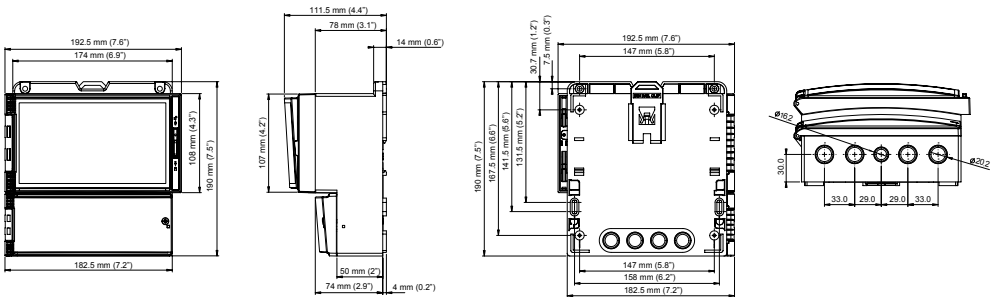

Minimum Measurement Range

Sultan Acoustic Wave Series



Each Transducer frequency has a different Blanking distance and recommended minimum distance (or high level) between the sensor face and measured product. This distance is measured from the sensor face or the bottom tip of flange down depending on model.

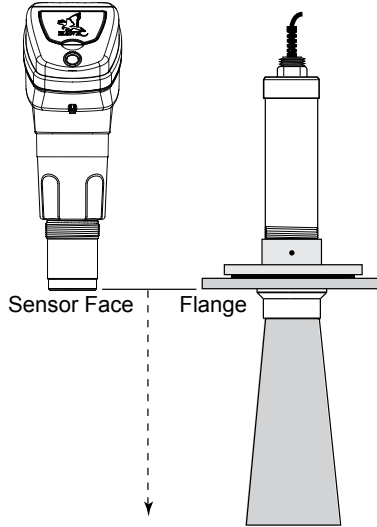

Part No.	Frequency	Minimum	Nominal	Conservative
AWRT50	50kHz	0.25m (10")	0.3m (1ft)	0.35m (1.2ft)
AWRT40	40kHz	0.3m (1ft)	0.35m (1.2ft)	0.4m (1.3ft)
AWRT30	30kHz	0.35m (1.2ft)	0.4m (1.3ft)	0.5m (1.6ft)
AWRT20	20kHz	0.45m (1.5ft)	0.6m (2ft)	0.7m (2.2ft)
AWRT15	15kHz	0.6m (2ft)	0.7m (2.2ft)	1.0m (3.2ft)
AWRT10	10kHz	0.75m (2.5ft)	1.1m (3.6ft)	1.3m (4.2ft)
AWRT05	5kHz	1.0m (3.2ft)	1.5m (4.9ft)	1.8m (5.9ft)

Always use conservative nominated distances if possible



AWR Remote Transmitter

AWR234

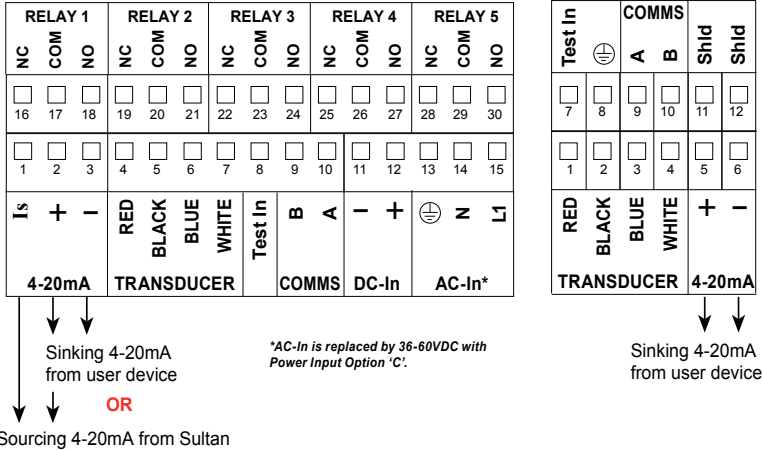

AWI Integral Transmitter

AWI234

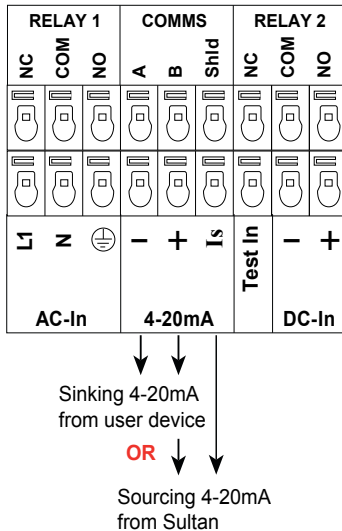

AWI2

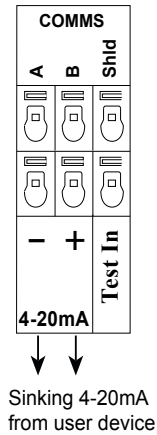



During running mode the Sultan will always display the selected primary display mode. There are further options referred to as 'diagnostics' which can be accessed using the arrow buttons which give immediate information about unit performance.

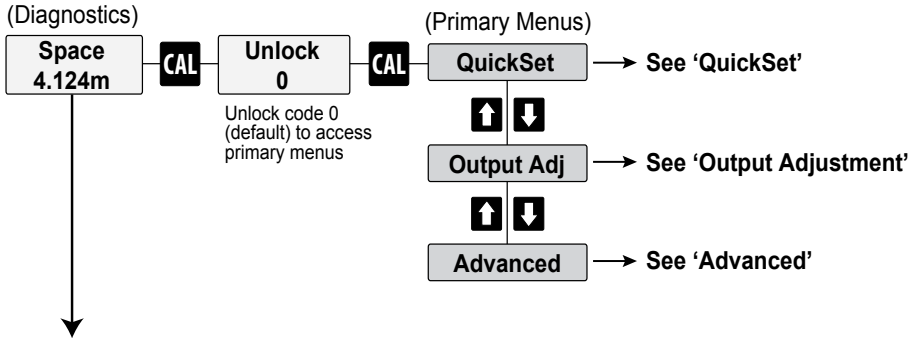

If you press the pushbuttons while the unit is in normal operation mode (displaying Space, Material% etc) the following diagnostic are shown (example values).

E:	Echo	4.2	Current distance the unit is detecting with each pulse (does not include output damping values)
S:	Size	1.11V	Echo size in volts - A high value (1.6-2V) indicates the unit may have too much gain for the current distance
Gn:	Gain	37.6%	Amount of gain applied at distance echo is detected
R:	Recover	2.3%	The amount of recover gain the unit is currently applying on top of normal gain to track the level
N:	Noise	1.9%	External noise level of similar frequency to Transducer (eg bulk solids filling)
T:	Temperature	23.2°C	Temperature at sensor face
Win Fwd		3.6m	Tracking Window starting distance
Win Bk		4.8m	Tracking Window finishing distance
Normal		Normal	Unit operational mode: Normal operation if tracked echo is above minimum threshold. Default minimum is 0.4V Recover if below minimum threshold, the unit will search for an echo for as long as the fail time

Quickset Flow Chart

Sultan Acoustic Wave Series

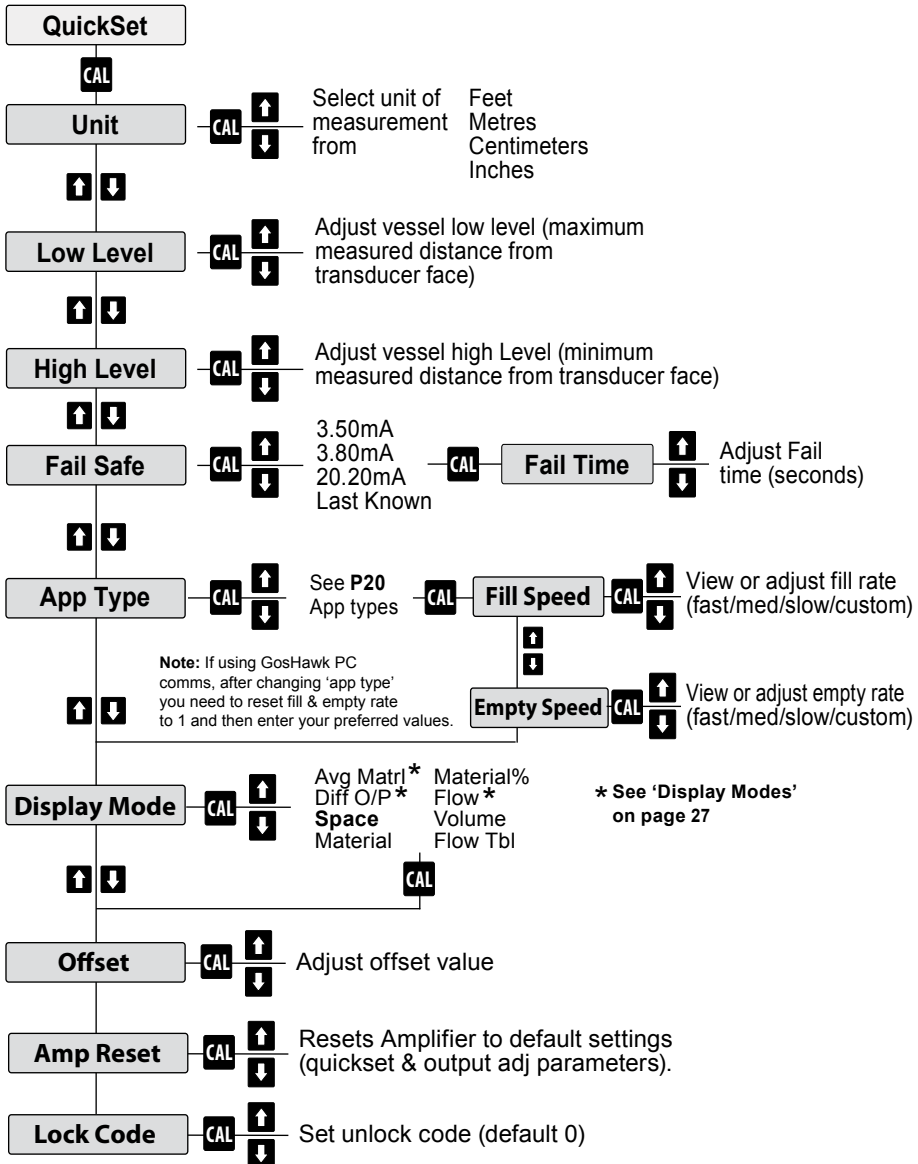



Quickset

To access to the **Quickset** parameter menu, press and hold the **CAL** button until “Unlock 0” is displayed on the LCD. Then use the **↑** **↓** buttons to select the access code.

The factory default is 0.

Unit

Allows the user to select the units for display of measured distances and relay set point programming. The choices are metres / centimetres or feet / inches.

Low Level

Sets the distance from the face of the transducer that corresponds to the low level in the vessel being monitored (4mA analog output level).

High level

Sets the distance from the face of the transducer that corresponds to the High level in the vessel being monitored (20mA analog output level).

Note: There must be a minimum span of 100mm between high & low levels.

Fail-Safe

Allows the user to select their preferred fail safe condition the 4-20mA output will transmit when the unit enters fail safe mode. There are 5 possible mA output failure values. They are: 20mA, 4mA, Last Known, <4.00mA and >20.00mA.

Application Type

Allows the user to select the type & speed of the customer application to automatically program unit settings. See dedicated ‘Application type’ on next page.

Display Mode

Allows the user to select the primary display mode reading. Options are average material, diff o/p, space, material, material%, flow, volume and flow tbl. ‘Space’ is default.

Lock Code

Allows the user to set an access code other than 0 to avoid unauthorised changes to the programming. Use the **↑** **↓** buttons to select the desired access code.

Application Types

Sultan Acoustic Wave Series



HAWK introduced additional application types to the Sultan series in software v5.78 (released 16 March 2012) along with a basic selection of process speed of 'fast', medium, or 'slow'. You can also manually select and adjust the fill & empty speeds (in selected unit per hour eg metres per hour) by using the 'Custom' option.

The application types are selectable in the 'Quickstart' menu. After you select the application type the first menu you will see is 'view'. To modify the settings use the arrows to scroll to 'fast', 'medium', 'slow' or 'custom'. 'View' displays the currently selected speeds.

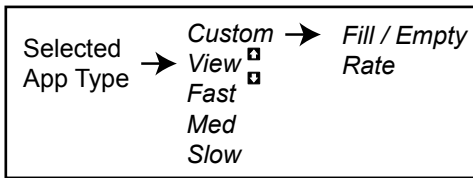

Bin Level

Fast	Fill	100m/h	Empty	100m/h
Med	Fill	50m/h	Empty	50m/h
Slow	Fill	10m/h	Empty	10m/h

Cement

Fast	Fill	20m/h	Empty	20m/h
Med	Fill	10m/h	Empty	10m/h
Slow	Fill	5m/h	Empty	5m/h

Coal

Fast	Fill	100m/h	Empty	100m/h
Med	Fill	50m/h	Empty	50m/h
Slow	Fill	10m/h	Empty	10m/h

Conveyor

Fast	Fill	6000m/h	Empty	6000m/h
Med	Fill	3000m/h	Empty	3000m/h
Slow	Fill	1000m/h	Empty	1000m/h

Crusher

Fast	Fill	800m/h	Empty	800m/h
Med	Fill	200m/h	Empty	200m/h
Slow	Fill	20m/h	Empty	20m/h

Detection

Fast	Fill	6000m/h	Empty	6000m/h
Med	Fill	3000m/h	Empty	3000m/h
Slow	Fill	1000m/h	Empty	1000m/h

Iron Ore

Fast	Fill	100m/h	Empty	100m/h
Med	Fill	50m/h	Empty	50m/h
Slow	Fill	5m/h	Empty	5m/h

Liquids

Fast	Fill	200m/h	Empty	200m/h
Med	Fill	50m/h	Empty	50m/h
Slow	Fill	5m/h	Empty	5m/h

Agitated Liquids

Fast	Fill	200m/h	Empty	200m/h
Med	Fill	60m/h	Empty	60m/h
Slow	Fill	10m/h	Empty	10m/h

Agitated Liquids

Fast	Fill	200m/h	Empty	200m/h
Med	Fill	50m/h	Empty	50m/h
Slow	Fill	10m/h	Empty	10m/h

Ore

Fast	Fill	100m/h	Empty	100m/h
Med	Fill	50m/h	Empty	50m/h
Slow	Fill	5m/h	Empty	5m/h

Plastics

Fast	Fill	20m/h	Empty	20m/h
Med	Fill	10m/h	Empty	10m/h
Slow	Fill	5m/h	Empty	5m/h

Application Types

Sultan Acoustic Wave Series



Positioning

Fast	Fill	4000m/h	Empty	4000m/h
Med	Fill	2000m/h	Empty	2000m/h
Slow	Fill	1000m/h	Empty	1000m/h

Powder

Fast	Fill	30m/h	Empty	30m/h
Med	Fill	15m/h	Empty	15m/h
Slow	Fill	5m/h	Empty	5m/h

Reflective

Fast	Fill	20m/h	Empty	20m/h
Med	Fill	10m/h	Empty	10m/h
Slow	Fill	5m/h	Empty	5m/h

ROM Bin

Fast	Fill	1200m/h	Empty	400m/h
Med	Fill	700m/h	Empty	250m/h
Slow	Fill	300m/h	Empty	100m/h

Silo Level

Fast	Fill	100m/h	Empty	100m/h
Med	Fill	50m/h	Empty	50m/h
Slow	Fill	10m/h	Empty	10m/h

Slurry

Fast	Fill	100m/h	Empty	100m/h
Med	Fill	50m/h	Empty	50m/h
Slow	Fill	20m/h	Empty	20m/h

Solids

Fast	Fill	100m/h	Empty	100m/h
Med	Fill	50m/h	Empty	50m/h
Slow	Fill	10m/h	Empty	10m/h

Stockpile

Fast	Fill	200m/h	Empty	200m/h
Med	Fill	50m/h	Empty	50m/h
Slow	Fill	20m/h	Empty	20m/h

Sump

Fast	Fill	200m/h	Empty	200m/h
Med	Fill	40m/h	Empty	40m/h
Slow	Fill	10m/h	Empty	10m/h

Process Sump

Fast	Fill	1000m/h	Empty	1000m/h
Med	Fill	300m/h	Empty	300m/h
Slow	Fill	20m/h	Empty	20m/h

Tank Level

Fast	Fill	200m/h	Empty	200m/h
Med	Fill	50m/h	Empty	50m/h
Slow	Fill	5m/h	Empty	5m/h



Non-standard display modes

AvgMatrl and **Diff O/P** are special operation modes which require two transducers connected to an amplifier via a junction box. Avg Matrl calculates the average level measured by the two transducers and Diff O/P calculates the difference in level between the two transducers. You will need to assign one transducer to ID2. To do this connect only one of the transducers, enter 'Quickset' and change the display mode to AvgMatrl or Diff O/P. Scroll down until you see 1:Sen Add 1 option, press CAL, select '1' for current transducer and press CAL again. The menu then proceeds to Tx Add.; press CAL to edit, press UP to scroll from 1 to 2 and press CAL to save. The currently connected transducer is now on ID2 - you can now connect the other transducer to the junction box which will be ID1 to complete the measurement pair required for Average & Differential measurement..

The **Flow** option can be used for basic open channel flow applications with a known Exponent value of the flume/channel/weir and the known max flow rate. Low & High level need to be set to represent the distance from the transducer face of 0-100% possible flow of the application. For more comprehensive flow measurement please see the dedicated flow measurement unit the Sultan Flow.

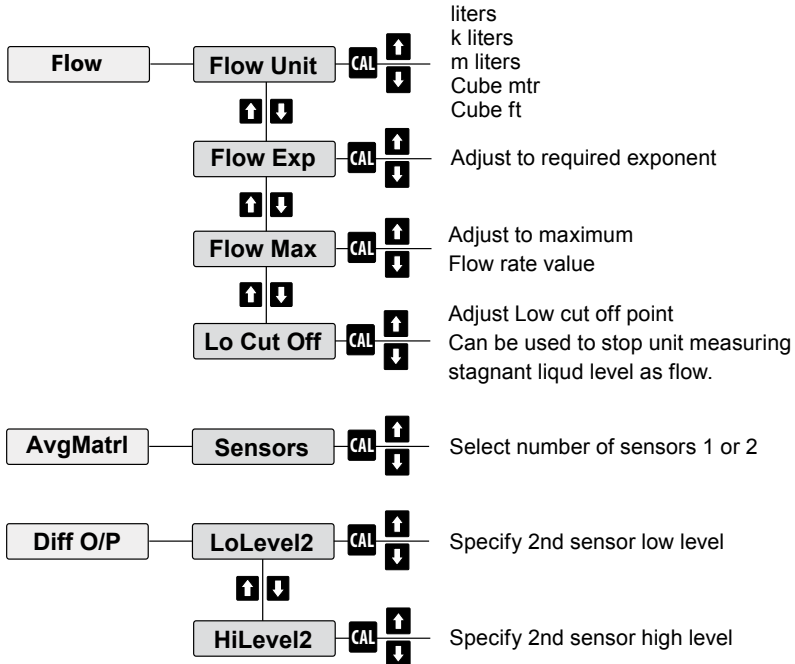

***Press RUN twice at any time to revert to normal operation**

Average Level

Sultan Acoustic Wave Series



Note: Average level requires a junction box AWRT-JB-01

What is Average Level?

Average Level (AvgMatrl) is used to measure the average of two levels using two Transducers and one amplifier providing one output. The Transducers are referred to as Sensor 1 and Sensor 2.

Average Material Calculation

The display mode 'AvgMatrl' (Average Material) gives a result calculated as follows:

$$\text{AvgMatrl} = \text{LowLevel} - \text{AvgSpace}$$

where

$$\text{AvgSpace} = (\text{Space1} + \text{Space2} + \text{offset})/2$$

Analog Output

Analog output is calculated based on the average material level.

The span of the analog output is defined by the LowLevel and HiLevel parameters. The analog output is calculated as follows:

$$\text{Current (mA)} = 16 * \text{AvgMatrl} / (\text{LowLevel-HiLevel}) + 4\text{mA}$$

Relays

The relays are switched based on the average space value. The relay set points L1 and L2 should be set considering the average space values at which the relay is required to switch.

Setting Sensor ID

You will need to assign one transducer to ID2.

To do this perform the following steps

1. Connect only one of the transducers
2. Enter 'Quickset' and change the display mode to AvgMatrl
3. Scroll down until you see 1:Sen Add 1 option.
4. Press CAL to edit. Select '1' for current transducer and press CAL again.

The menu then proceeds to Tx Add;

5. Press CAL to edit, press UP to scroll from 1 to 2 and press CAL to save.

The currently connected transducer is now on ID2

You can now connect the other transducer to the junction box which will be ID1 to complete the measurement pair required.

Accessing both Sensors Parameters

Both Sensor 1 and Sensor 2 parameters can be accessed through the KeyPad.

The parameter '**Sensor**' in '**Advanced**' determines which sensor (1 or 2) will be currently accessed if required to adjust settings.



Note: Differential level requires a junction box AWRT-JB-01

What is Differential Level?

Differential Level (Diff O/P) is the term used to define the measured difference between two material levels using two Transducers. The Transducers are referred to as Sensor 1 and Sensor 2.

Diff Calculation

In differential Mode the material level measured by Sensor 1 is subtracted from the material level measured by Sensor 2. Negative results will be reset to zero. The differential value is calculated as follow:

$$\begin{aligned} \text{Diff} &= \text{MaterialLevel2} - \text{MaterialLevel1} \\ \text{MaterialLevel2} &= \text{LowLevel2} - \text{Space2} \\ \text{MaterialLevel1} &= \text{Lowlevel1} - \text{Space1} \end{aligned}$$

Analog Output

Analog output is calculated based on the differential value.

The span of the analog output is according to the Lowlevel1 and Hilevel1. The analog output is calculated according the following equation:

$$\text{Current (mA)} = 16 * (\text{Diff}) / (\text{LowLevel1} - \text{HiLevel1}) + 4\text{mA}$$

Setting Sensor ID

You will need to assign one transducer to ID2.

To do this perform the following steps

1. Connect **only one** of the transducers
2. Enter 'Quickset' and change the display mode to AvgMatrI
3. Scroll down until you see 1:Sen Add 1 option.
4. Press CAL to edit. Select '1' for current transducer and press CAL again.

The menu then proceeds to Tx Add.,

5. Press CAL to edit, press UP to scroll from 1 to 2 and press CAL to save.

The currently connected transducer is now on ID2

You can now connect the other transducer to the junction box which will be ID1 to complete the measurement pair required.

Accessing both Sensors Parameters

Both Sensor 1 and Sensor 2 parameters can be accessed through the KeyPad.

The parameter '**Sensor**' in '**Advanced**' determines which sensor (1 or 2) will be currently accessed if required to adjust settings.

Relays

Relay Mode = EN (L1 < L2)	Relay Mode = DEN (L1 < L2)
OFF	ON
L2 = Diff2 _____	L2 = Diff2 _____
L1 = Diff1 _____	L1 = Diff1 _____
ON	OFF



Advanced settings adjusts the transducer sensing characteristics. It is not recommended you adjust these settings unless you are familiar with the effect they will have on your unit.

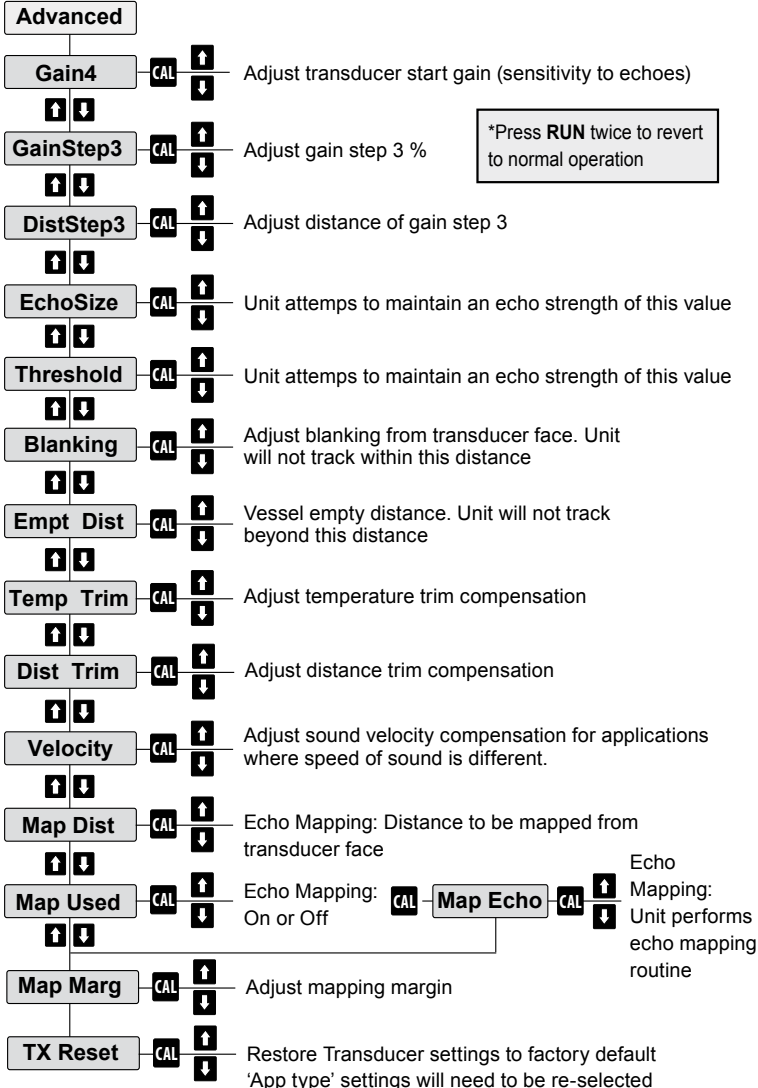

Press CAL to pulse the unit while adjusting Tx settings. Distance to level will be shown.



Gain4 (Gn):

This parameter is to increase or decrease the starting Gain4 value (sensitivity to return echoes). Gain4 is the primary gain control. The start point of this % is after Gain Step 3 / Distance Step 3.

The result of changes can be seen immediately by pressing CAL while adjusting the % (the unit will pulse once and display distance & echo size). A 'good' signal size is approximately 0.8V. A signal above 2V suggests Gain4 is too high.

Gain Step 3 / Distance Step 3 (G3 / D3):

Normally G3 and D3 are considered and adjusted as a pair, and should only need adjustment to assist in 'high level' lock ups or structures close to and around the transducer face (see troubleshooting / locking onto high level).

The result of changes can be seen immediately by pressing CAL while adjusting the % (the unit will pulse once and display distance & echo size).

EchoSize

The unit uses automatic gain control to maintain echo size to this value. While the unit is operating it is displayed as the diagnostic S:. The default settings for solid based applications is 0.6V and for Liquid based applications 0.8V.

Threshold

Threshold is the minimum echo size the unit will track. Any echo which passes this value (0.39V) the unit will use automatic gain control to track and hold to the EchoSize.

Blanking

The Blanking Distance is the minimum amount of space which should be between the transducer face and the product being monitored. This distance is a blank zone, the unit will not track anything within this distance.

Where possible use the conservative values and increase this distance by 50% if there is foam, dust, steam, or condensation.

See also 'Minimum Measurement Range'

Empty Distance

The Empty Distance is similar to Blanking, the unit will not track any echoes beyond this distance. Be conservative with this value, any empty bin with a conical bottom may require additional distance due to pulses reflecting of the cone angle before returning to the sensor face.

Digital Mapping

Digital mapping is a process where the unit scans a vessel for all potential false echoes and applies a filter to ignore them. Mapping should be considered a last resort, it may interfere with the units ability to follow the process level if not applied correctly.

Map Distance

The total distance (measured from transducer face) the unit will map.

Map Echo

Commences mapping process.

Map Used

Select only a portion of the Map Distance to use parameter (measured from transducer face)

Map Margin

This value is the amount of gain applied to the mapped echoes. This value should be adjusted in small amounts, if the value is set too high the mapped echoes will be very large resulting in the unit struggling to correctly following process level while it passes the mapped area.

Output Adjustment Setup Menu

Sultan Acoustic Wave Series

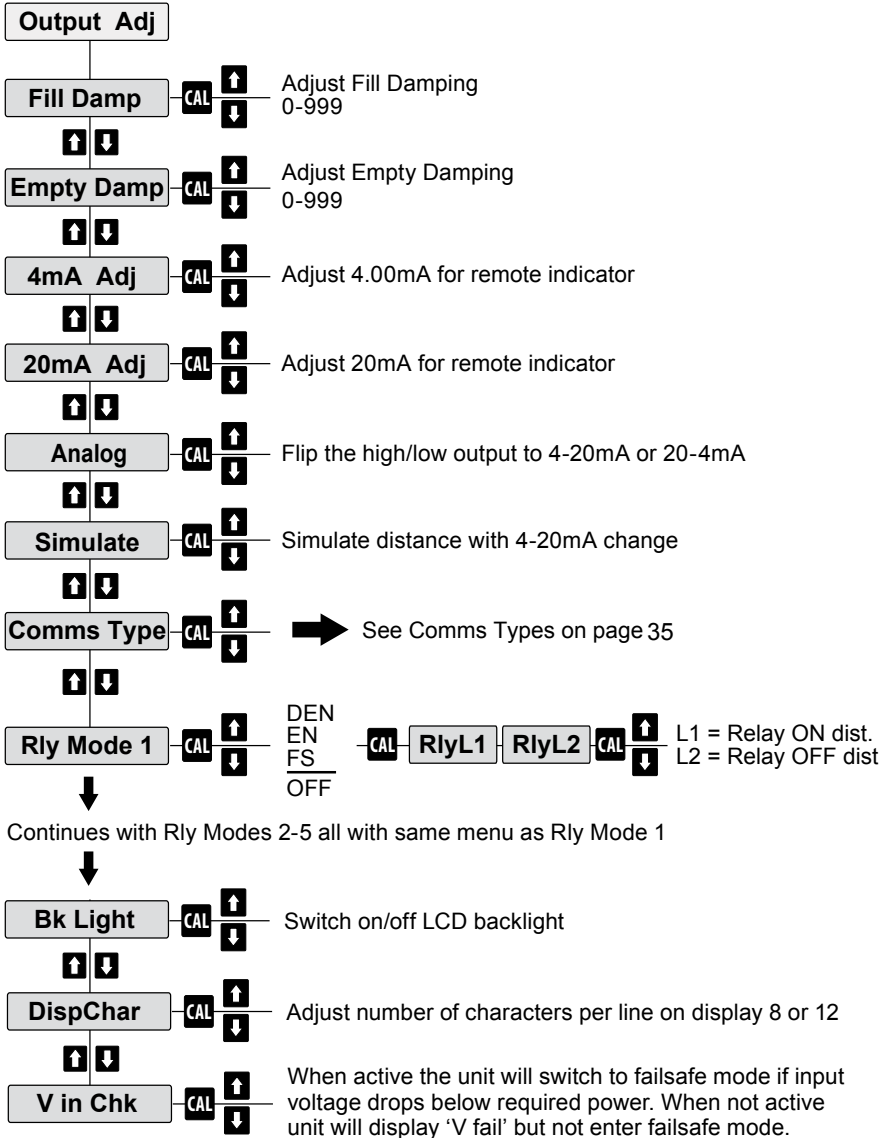

Press RUN twice to revert to normal operation

Output Adjustment Parameters

Sultan Acoustic Wave Series



Output Adjustment settings configure Analog, Relay and communication settings.

You can also adjust the fill and empty damping for smoother mA output readings

Fill & Empty Damping

Allows the user to define how quickly the unit responds to changes in the measured level. A low damping value gives a fast response and a high damping gives a slow response. The damping limits are from 0 to 999. Eg: If you set the damping to a value of 10, the displayed distance will be a rolling average of the last 10 pulses. The displayed distance includes the 4-20mA output and the default display mode value. Generally it is recommended this value is not lower than 5-10 for fast filling applications.

4mA Adj & 20mA Adj

Whilst the display shows '4mA Adj' or '20mA Adj', the analog (4-20mA) current output will be forced to its respective 4mA or 20mA state. The actual loop current can be measured with an external meter and calibrated exactly by pressing the **UP** or **DOWN** arrows until the external meter reads exactly 4.000mA or 20.000mA. Pressing the **CAL** button will store the calibration in the instruments memory.

Analog

4-20/20-4mA The analog current output of the instrument can be set to act in the normal (4-20mA) or reverse (20-4mA). The default condition is 4-20mA, where the furthest distance from the transducer (low level) is output as 4mA, and current increases with filling to the closer (high level) span point of 20mA.

Simulate

(Y/N): Select **Y** to access measurement simulation mode. In simulation mode, the **UP** and **DOWN** arrow keys vary the distance on the display. The current output and any relays used will behave exactly as they should do if the measured distance (in **SPACE** mode without damping) was that shown on the display.

This mode can be used to test correct behavior of outputs, or externally connected equipment.

Relays

Allows the user to set the relays for switching. The relays are programmed in a distance from the transducer face to the position where switching is required. Relays work in the following manner:

OFF The relay will always remain off

The relays can be programmed to energise (**EN**) or de-energise (**DEN**) depending on the product level in the vessel being monitored.

FS If FS is selected, the relay will operate as a fail safe relay. The relay will be energised at all times and will de-energise if the ultrasonic switch goes in to failsafe condition or if anything interferes with the unit's ability to keep the relay energised.

See also 'Relay Functions' for further information about the Relay switching on the next page.

Bk Light

Switch on/off LCD backlight

DispChar

Adjust number of characters per line 8 or 12. Some older units may have an 8 character display only.

V in Chk

The Sultan automatically detects if the input voltage below 9.5V for 234 wire units and 7V for 2 wire units. When this mode is active the unit will begin its failsafe routine and eventually display V fail. When not active the unit will still display the message 'Input voltage too low'.



Relay 1 - 5

Sub-Menu	Description	Options
RlyL1 1-5	Adjust Relay switch point (L1 must be < L2)	Adjustable
RlyL2 1-5	Adjust Relay switch point (L2 must be > L1)	Adjustable

- Set Relay Parameters in Output Adjustment menu
- The two relay levels are RlyL1 and RlyL2
- The display will show RlyL1 1, the last 1 indicated the Relay number (eg 1 to 5)
- L1 and L2 distances are measured from the transducer face

		Relay Action				
		Energise EN	DeEnergise DEN	FailSafe FS system operating normally	FailSafe FS power/system/ measurement failure	OFF
State 1						
State 2						
POWER FAILURE						

Comm Types Setup Menu

Sultan Acoustic Wave Series



All HAWK products come standard with Modbus. If a unit supports additional communications protocols, it will be indicated on the wiring label inside the unit and the part number.

Foundation Fieldbus and Profibus PA have stand alone manuals located in the downloads-manuals section of www.hawkmeasure.com

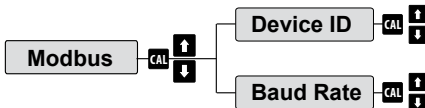
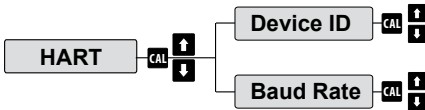
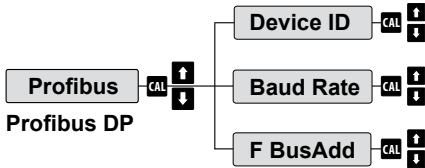
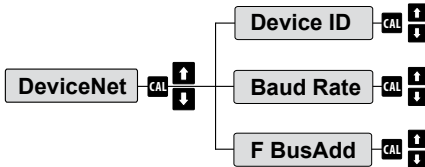
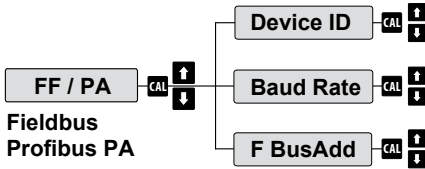



Modbus setup & basic spans & diagnostic registers for HAWK Sultan Series instruments v3.85 and later.

Protocol: Modbus RTU (2 wire)
Speed: 19200 Baud
Data bits: 8
Parity: None
Stop Bits: 1

HAWK Sultan series units act as 'slave' devices on a Modbus network.

Units are shipped from the factory with a default Modbus address of 1. The Modbus address of any unit can be changed individually if units are to be connected in a multi-drop network. Each address number must only be used once on any network (possible addresses are 1-255).

Diagnostic Block (Read Only): *Can be read as Singles or any Block wholly within the limits of this range of addresses*

- 40123 - LOW LEVEL span set point in mm
- 40124 - HIGH LEVEL span set point in mm
- 40125 - DISPLAYED DISTANCE (DISTANCE) in mm
- 40127 - NEW DISTANCE (E-DISTANCE) in mm
- 40128 - CONFIRM DISTANCE (C-DISTANCE) in mm
- 40129 - ECHO SIZE in Volts/102
- 40130 - GAIN at Echo detection point in %/7.5
- 40131 - NOT USED (Gain Limit)
- 40132 - RECOVER GAIN in %/7.5
- 40133 - NOISE in %/7.5
- 40134 - TEMPERATURE in Degrees K/10
(DegreesC - 273.2)/10)
- 40136 - CONFIRM COUNTER current value
- 40137 - HOLD COUNTER current value
- 40139 - WINDOW FORWARD POSITION in mm
- 40140 - WINDOW BACK POSITION in mm

Span Adjustment (Read/Write) **MUST** Read/Write SINGLES-NOT BLOCKS:

- 40011 - LOW LEVEL span set point in mm
- 40012 - HIGH LEVEL span set point in mm

Relay Function Adjustment (Read/Write) **MUST** Read/Write SINGLES-NOT BLOCKS:

- 40051 - Relay 1 Mode setting
 - 0-OFF
 - 1-FS (Failsafe)
 - 2-EN (Energise on Level)
 - 3-DEN (De-Energise on Level)
- 40052 - Relay 2 Mode setting (see Relay 1)
- 40053 - Relay 3 Mode setting (see Relay 1)
- 40054 - Relay 4 Mode setting (see Relay 1)
- 40055 - Relay 5 Mode setting (see Relay 1)
- 40035 - Relay 1 L1 set point in mm
- 40036 - Relay 1 L2 set point in mm
- 40037 - Relay 2 L1 set point in mm
- 40038 - Relay 2 L2 set point in mm
- 40039 - Relay 3 L1 set point in mm
- 40040 - Relay 3 L2 set point in mm
- 40041 - Relay 4 L1 set point in mm
- 40042 - Relay 4 L2 set point in mm
- 40043 - Relay 5 L1 set point in mm
- 40044 - Relay 5 L2 set point in mm

Modbus

Sultan Acoustic Wave Series



Extended Parameters (Read/Write) ***MUST** Read/Write SINGLES-NOT BLOCKS*:

40059 - DISPLAY UNITS

- 3-Millimetres
- 4-Centimetres
- 5-Metres
- 6-Feet
- 7-Inches

40014 - FAILSAFE MODE

- 0 - 3.5mA
- 1 - 3.8mA
- 2 - 20.2mA
- 3- Last Known
- 4 - 4.0mA
- 5 - 20.0mA

40015 - FAILSAFE TIME (seconds)

40016 - APPLICATION TYPE

- 0 - Liquid
- 1 - Solid
- 2 - Slurry
- 3 - Position

40017 - FILL RATE (metres per hour/10)

40018 - EMPTY RATE (metres per hour/10)

40019 - DISPLAY MODE

- 1 - Volume
- 2 - Flow
- 3 - Material %
- 4 - Material
- 5 - Space
- 6 - Differential Output
- 7 - Average Material

40032 - OFFSET (mm)

40020 - LOCK CODE

40021 - FILL DAMPING

40022 - EMPTY DAMPING

40063 - ANALOG

- 0 - 4-20mA (4mA low, 20mA high - standard)
- 1 - 20-4mA (20mA low, 4mA high - inverted)

40447 - GAIN parameter setting in %/7.5

40448 - GAIN STEP in %/7.5

40449 - DISTANCE STEP (mm)

40450 - THRESHOLD in Volts/100

40451 - BLANKING (mm)

40452 - EMPTY DISTANCE (mm)



Setting the Baud Rate and the DeviceNet Address

The DeviceNet factory default of Baud Rate and FBus Address are 125kbps and 63 in a Sultan unit with. To modify these values follow the instructions below.

1. Go to the 'Output Ad' menu
2. Use the Up and Down push buttons to reach the CommType parameter
3. Make sure that the **CommType** is set to 'DeviceNet'
4. Press the CAL button twice
5. DeviceID will be displayed - this ID is for Modbus networking, do not adjust.
6. Use the Down push button to reach the BaudRate parameter
7. The default value for the BaudRate is 125kbps. Press CAL button and use the Up and Down push buttons to modify this value
8. Press CAL button when finished
9. Use the Down push button to reach the FBusAdd. The default value of the FieldBus Address is 63. Press CAL button and use the Up and Down push buttons to modify this value
10. Press CAL button again when finished
11. Press RUN to save and several times again to return the unit to operating mode.

Output Data

Profibus/DeviceNet now transmit 18 bytes/9 words, description of the words is as follows (For firmware version 5.54 and above).

1. Displayed Distance
(Space Distance is the Primary Variable)
2. Percentage (Percent of Range)
3. Hi Level (Upper Range)
4. Low Level (Lower Range)
5. Status Flags
Bit0 = Echo was received inside the span.
Bit1 = Echo is Confirmed.
Bit3 = Searching is searching for an Echo.
BitF = Unit has Failed to detect an Echo.
6. Displayed Distance2 (Second Variable)*
7. Percentage2 (Second Percent of Range)*

*Used for Differential output on a Sultan

Integral

DEVNET			COMMS			RL1		
A	B	shld	A	B	shld	NC	COM	NO
⊖	⊖	⊖	⊖	⊖	⊖	⊖	⊖	⊖

AC-IN			DEVNET			TEST	DC-IN	
LI	N	⊕	shld	GND	24V+		-	+
⊖	⊖	⊖	⊖	⊖	⊖	⊖	⊖	⊖

Remote

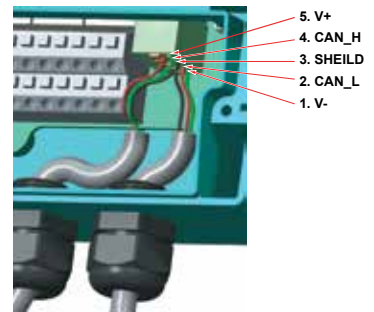

Bit F	Bit E	Bit 3	Bit 1	Bit 0
Failed	~~~~~	Search	0	Echo Cfm : 1 = , True, 0 = False
				Echo R : 1 = , True, 0 = False



Setting the Profibus DP Address

Factory defaults of FBusAdds is 126 in a Sultan unit with Profibus CommType. To modify this value follow the instruction below:

1. Go to the 'Output Ad' menu
2. Use the Up and Down push buttons to reach the CommType parameter
3. Make sure that the **CommType** is set to 'Profibus'
4. Press the CAL button twice
5. DeviceID will be displayed - this ID is for Modbus networking, do not adjust.
6. Use the Down push button to view the BaudRate parameter. The value for the BaudRate is selected automatically and can not be modified.
8. Use the Down push button to reach the FBusAdds. The default value of the FieldBus Address is 126. Press CAL button and use the Up and Down push buttons to modify this value.
9. Press CAL button again when finish.
10. Press RUN several times to return the unit to operating mode.

Output Data

DeviceNet now transmits 18 bytes/9 words, description of the words is as follows (For firmware version 5.54 and above)

1. Displayed Distance
(Space Distance is the Primary Variable)
2. Percentage (Percent of Range)
3. Hi Level (Upper Range)
4. Low Level (Lower Range)
5. Status Flags
 Bit0 = Echo was received inside the span.
 Bit1 = Echo is Confirmed.
 Bit3 = Searching is searching for an Echo.
 BitF = Unit has Failed to detect an Echo.
6. Displayed Distance2 (Second Variable)*
7. Percentage2 (Second Percent of Range)*

**Used for Differential output*

Wiring

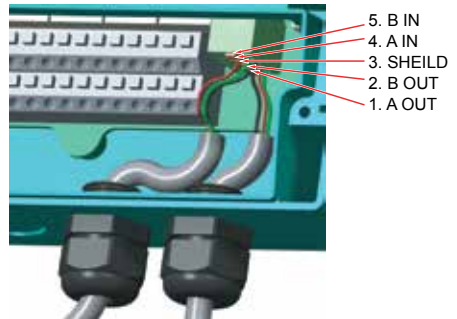

Bit F	Bit E	Bit 3	Bit 1	Bit 0
Failed	~~~~~	Search	0	Echo Cfm : 1 = , True, 0 = False
				Echo R : 1 = , True, 0 = False



HAWK provides free in-house developed software called GosHawkII. This software is supported by all current products and is used by HAWK Engineers & HAWK authorised representatives during commissioning, testing and monitoring unit performance.

The software allows easy access to unit setup menus using a PC rather than the keypad and gives a visual representation of what the unit is seeing (all echoes which pass the unit filter), transmitting and displaying on the unit face.

The best and easiest way to set up, troubleshoot and monitor a HAWK unit is via GosHawkII.

To connect to a unit using this software you need either a HawkLink modem or HawkLink USB connector.

For a multidrop network GosHawkII uses a Modbus ID to identify each unit.

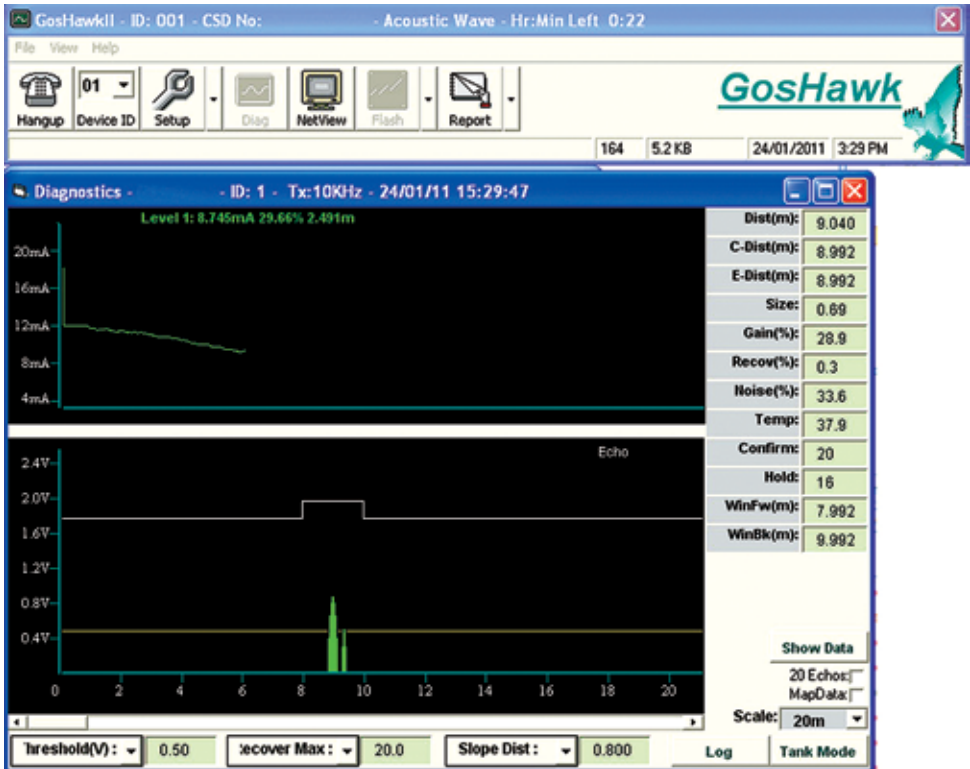

Converting 234 Wire to 2 Wire Loop

Sultan Acoustic Wave Series



Sultan234 units can be switched to 2 wire loop mode by flipping a SMART card on the analogue module. The module is located behind the display and will have MOD-AN moulded on the plastic as well as a sticker indicating the orientation of the SMART card for both modes

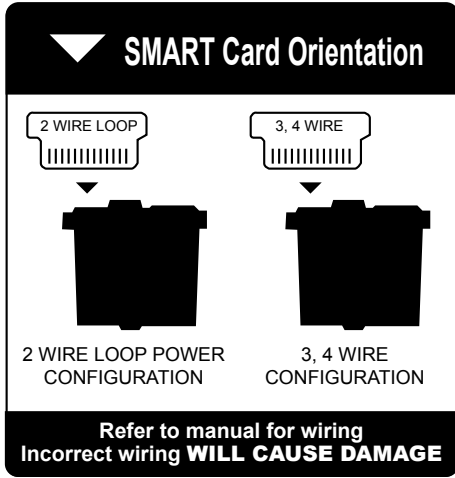

The card is secured by a small brown plastic lock. Gently lift both tips of the plastic lock until they click up to release the lock. Gently lift the card out and flip to the required mode. Place the card back in and re-lock down the plastic bracket.

The procedure is delicate, it is recommended to be performed in a workshop or lab and not in the field.



Remove screws

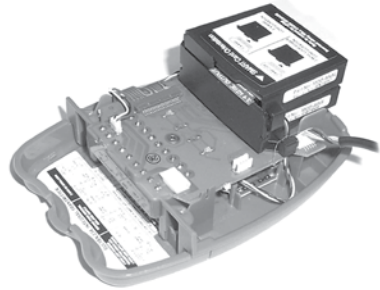

Remove screws



Troubleshooting

Sultan Acoustic Wave Series



- 39. Unit displays or transmits distance that is higher than the actual level / unit is locking on high level
- 40. Output doesn't match level during filling / emptying
- 40. Output is erratic / inconsistent
- 40. Replacing the amplifier or transducer
- 41. Hardware checks - Voltage & Resistance (Remote & Integral)
- 42. Error Codes
- 43. Contacting HAWK



Unit displays or transmits distance that is higher than the actual level / unit is locking on high level

1. Check the mounting conditions within the vessel.
Are there any obstacles in front or near the front & side of the face of the transducer? If so, consider moving the unit to a different location.
2. Check the distance of the false echo. If this is above your high level you can change the unit sensitivity to the echo. In 'Advanced' change the 'Dist Step3' to a distance further than the echo, and lower the 'Gain Step3' to make the unit less sensitive for the 'Dist Step' distance.

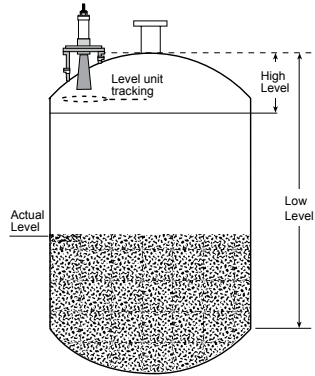

If the echo is below the 'High Level', you can still modify the Distance & Gain Steps3 to solve the problem. Consider lowering the 'High Level' value below the 'Dist Step3'.

If you cannot do this, lower the 'Gain4' value (also located in 'Advanced') incrementally until the unit cannot see the problem echo.

Lowering the Gain4 % will affect overall sensitivity of the unit. It will reduce unit capability. If you need to lower this value by 5-10% to avoid the unit locking onto an obstacle you must consider step 1 (adjusting mounting location).

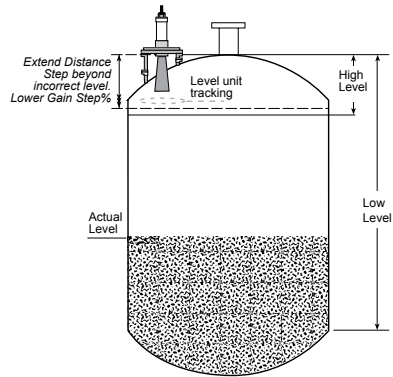

3. You can extend the 'Blanking' (TX Setup) distance to 'blank' the echo entirely. Anything within this 'Blanking' distance will NOT be tracked by the unit under any circumstances. Consider this in case of accidental over filling. Never have the 'Blanking' distance longer than the 'High Level'.

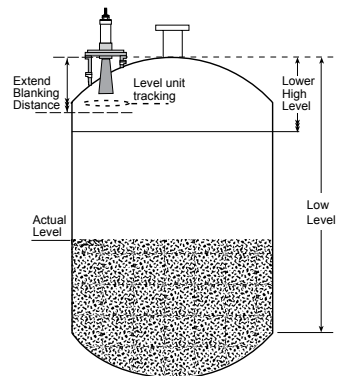

Output

Sultan Acoustic Wave Series



Output doesn't match level during filling / emptying

Ensure the span programmed into your PLC matches the span (high & low level) programmed into the unit

Ensure the Fill Rate and/or Empty rate is set fast enough for your application.

If the unit is 'locked' showing a higher level than see 'Unit displays or transmits distance that is higher than the actual level'.

Ensure resistance load is within HAWK specification on analog wires.

Output is erratic / inconsistent

Increase the 'damping' values to stabilise unit response times. The settings are in 'Output Adjustment' menu as 'FillDamp' and 'EmptyDamp'.

If material being measured forms angle of repose try adjusting Transducer mounting angle to get better reflections

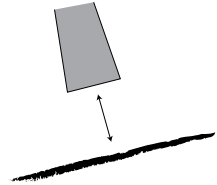

For analogue output related problems it is important to isolate the Sultan (disconnect from the network) and use a multimeter to read the analogue terminals directly.

Replacing a Transducer or Amplifier

If replacing either the amplifier or transducer you must re-enter your application settings into the unit.

Consider stocking spare amplifiers and transducers to avoid potential down time.

Unit Voltage Specs & Checks

Sultan Acoustic Wave Series



Remote & Integral

Sultan 234

Specified ranges (supply dependent): 90-260VAC, 12-30VDC, 36-60VDC). For suspected power issues ensure user supply is appropriate & consistent.

If using AC power you can check the power supply for faults by reading the DC +/- terminals with a multimeter set to DC. This terminal will produce 15-16VDC stable. If this value is lower or inconsistent you may have a problem with the internal power supply.

Unit performance will be affected if the unit detects voltage below 9VDC. If 'V in chk' is on the unit will trigger its failsafe routine. If V in chk is off the unit will display V fail on the LCD.

Sultan 2

Specified ranges: 12-30VDC.

Unit performance will be affected if power drops below 7VDC. If 'V in chk' is on the unit will trigger its failsafe routine. If V in chk is off the unit will display V fail on the LCD.

Transducers

The Transducer power (red wire) should draw 8-10VDC. If this figure is too high or too low check Sultan power & supplied power as above.

Check Resistances between transducer wires (approximate values):

Black - Blue = 15.6Kohms

Black - White = 15.6Kohms

Resistances between transducer terminals (approximate values):

Black - Blue = 16.2Kohms

Black - White = 16.2Kohms



Error Codes 01 - 04

Error 01: Amplifier/Transmitter can not communicate with transducer.

Wiring:

Check the terminals for a loose or incorrect connection (including junction box/cable extensions). Check the cables for any signs of damage. Ensure any customer supplied cable meets HAWK specifications.

If using junction box extension trace the 8-9VDC from the red/black amplifier terminals to the transducer to ensure wires are correct. If using a junction box ensure you follow Hawk specification for extending cable.

When the unit powers up does the transducer pulse once? If it does this indicates the transducer has powered correctly (red/black terminals). Check the comms wiring (blue/white). If the transducer does not pulse once when the red/black wires are applied (wires must be the potted Transducer wires) the Transducer most likely has a fault or damage.

Has the transducer ID number been modified while connected to a different transmitter? Re-connect the unit to the previous transmitter and change the ID via Quickstart/SenAdd CAL TxAdds.

Error 01

It can also be caused by power supply related issues. See 'Unit Voltage Specs & Checks'.

Error 02:

Communication data corruption between Transmitter and Transducer.

It can be a result of noise in data lines or one of data lines (white or blue) being open circuit.

Make sure wiring is correct especially look to the screen (earth).

Ensure you are using quality shielded instrument cable.

If using a junction box ensure you follow HAWK specification for extending cable.

Integral units with Error 02 will be an internal problem, contact your Hawk representative.

Error 03

Specific comms mode is selected (eg Profibus, FF) but comms module is not connected or responding. Check your unit part number to ensure it has correct comms. If you do not have additional comms (option X) then select Modbus.

Error 04

Amplifier is programmed with incorrect software. Contact your local support.

In general Error Code 01 indicates there is NO communication and Error Code 02 says there IS communication, but not of sufficient quality to be read reliably.

Technical Support

Sultan Acoustic Wave Series



Before contacting Hawk for assistance please write down the 'Diagnostics' displayed on the unit to assist with support speed. See '**DIAGNOSTICS & SOFTWARE OVERVIEW**' for further information.

Also include a diagram or drawing of the vessel marked with where the transducer is installed along with photographs of the installation and what is below the transducer.



Sultan Remote Transmitter

Model

- AWR2 Remote 2 Wire, No relays, 12-30VDC only, Modbus
- AWR234 Remote 2 / 3 / 4 Wire, 5 relays, Modbus

Housing

- S Polycarbonate

Power Supply

- B 12-30VDC
- C¹ 36-60VDC
- U¹ 12-30VDC and 90-260VAC

Additional Communications (PC comms GosHawk standard)

- S¹ No additional communications (5 Relays, Modbus)
- X 4-20mA analogue
- H² 4-20mA analogue with HART 2 wire
- I¹ 4-20mA analogue with HART Isolated 4 wire
- A Profibus PA
- P¹ Profibus DP
- F Foundation Fieldbus
- D¹ DeviceNet
- E¹ 4-20mA with Modbus over Ethernet TCP/IP

This option is no longer available

- X Option no longer available

Approval Standard

- X Not Required
- i0³ IECEx Zone 0 Ex ia IIA T4 IP67 Tamb -20°C to 70°C
- A0³ ATEX Grp II Cat 1 GD IP67 EEx ia IIA T4
- i20³ IECEx Zone 20 DIP A20 TA85C IP68 Tamb -20°C to 75°C
- A20³ ATEX Grp II Cat 1 D T85°C IP67 Tamb -20°C to 75°C
- A22 ATEX Grp II Cat 3 GD T85°C IP67 Tamb -40°C to 70°C
- GP⁴ CSA Equip Class 2; Pollution deg 2; Tamb -20°C to 75°C (Ordinary Locations)
- RN^{3,4} CSA Class I; Div 1/2; Group D; Zone 0; AEx / Ex ia IIA; T4

Position Slave / Crane Master

- X Not Required
- PS¹ Position Slave
- CM¹ Crane Master

¹ Model AWR234 only

² Model AWR2 only

³ Model AWR2 only.
Communication Option W, X, H only

⁴ Power supply option 'B' only

AWR234 S U X X X X



Sultan Remote Transducer 3” and 3.5”

Model

AWRT Acoustic Wave Remote Transducer

Transducer Frequency

- 30 30kHz for applications up to 15m for 3” (Cone required1)
- 20 20kHz for applications up to 20m, 3” only (Cone required1)
- 15 15kHz for applications up to 30m, 3” only (Cone required1)
- 10 10kHz for applications up to 40m, 3.5” only (Cone required1)
- 09 9kHz Positioning / Position Slave applications up to 180m (Cone required1)
- 05 5kHz for applications up to 60m, 3.5” only (Cone required1)
- 04 4kHz Positioning / Position Slave applications up to 180m (Cone required1)

Process Temperature - Facing material selection

- S Polyolefin 80°C (176°F)
- T Teflon 80°C (176°F)
- Y Titanium 80°C (176°F)

Transducer Housing Material

- 4 Polypropylene

Back Cap Mounting Thread Standards

- X Not Required (Standard Flange Mount)
- TB BSP

Back Cap Mounting Thread Sizes

- X Not Required (Standard Flange Mount)
- 30 3” BSP
- 50 3.5” BSP

Approval Standard

- X Not Required
- i0 IECEx Zone 0 Ex ia IIA T4 IP67 Tamb -20°C to 70°C
- A0 ATEX Grp II Cat 1 GD IP67 EEx ia IIA T4
- i1 IECEx Zone 1 Ex mb II IP68 T5(Tamb -20°C to 65°C) T6(Tamb -20°C to 50°C)
- A1 ATEX Grp II Cat 2 GD EEx m II IP68 T5(Tamb -20°C to 65°C) T6(Tamb -20°C to 50°C)
- i20 IECEx Zone 20 DIP A20 TA85C IP68 Tamb -20°C to 75°C
- A20 ATEX Grp II Cat 1 D T85°C IP67 Tamb -20°C to 75°C
- A22 ATEX Dust (Grp II Cat 3 D T85C IP67)
- GP CSA Equip Class 2; Pollution deg 2; Tamb -20°C to 75°C (Ordinary Locations)
- RN CSA Class I; Div 1/2; Group D; Zone 0; AEx / Ex ia IIA; T4
- KN CSA Class II; Div 2; Group F&G; Class III; T6 T85 for Tamb -20°C to 75°C
- QN CSA Class II; Div 1; Group E, F&G; Ex mb II; T5(T100) for Tamb -20°C to 65°C; T6(T85) for Tamb -20°C to 50°C

Connection

- C IP68 Sealed unit with cable

Cable Length

- 6 6m cable
- 15 15m cable
- 30 30m cable
- 50 50m cable

Mounting Accessories

- X Not Required
- CS End Cap Cable Suspension

Software Options

- X Not Required
- FP Fast Pulsing
- PS Position Slave (Requires Position Slave Amplifier)

AWRT 10 T 4 X X X C 6 X X



Sultan Remote Transducer 2" Version

Model

AWRT Acoustic Wave Remote Transducer

Transducer Frequency

- 50 50kHz for liquid applications up to 5m (Cone required¹)
- 40 40kHz for liquid applications up to 7m (Cone required¹)
- 30 30kHz for liquid applications up to 11m (Cone required¹)

¹See 'Transducer / Cone / Flange combination table

Process Temperature - Facing material selection

- T Tefzel 80°C (176°F)

Transducer Housing Material

- 6 Tefzel

Thread Standard

- TB BSP
- TN NPT

Thread Size

- 20 2" thread

Approval Standard

- X Not Required
- i0 IECEx Zone 0 Ex ia IIA T4 IP67 Tamb -20°C to 70°C
- A0 ATEX Grp II Cat 1 GD IP67 EEx ia IIA T4
- i1 IECEx Zone 1 Ex mb II IP68 T5(Tamb -20°C to 65°C) T6(Tamb -20°C to 50°C)
- A1 ATEX Grp II Cat 2 GD EEx m II IP68 T5(Tamb -20°C to 65°C) T6(Tamb -20°C to 50°C)
- i20 IECEx Zone 20 DIP A20 TA85C IP68 Tamb -20°C to 75°C
- A20 ATEX Grp II Cat 1 D T85°C IP67 Tamb -20°C to 75°C
- A22 ATEX Grp II Cat 3 GD T85°C IP67 Tamb -40°C to 70°C
- GP CSA Equip Class 2; Pollution deg 2; Tamb -20°C to 75°C (Ordinary Locations)
- RN CSA Class I; Div 1/2; Group D; Zone 0; AEx/Ex ia IIA; T4
- KN CSA Class II; Div 2; Group F&G; Class III; T6 T85 for Tamb -20°C to 75°C
- QN CSA Class II; Div 1; Group E, F&G; Ex mb II; T5(T100) for Tamb -20°C to 65°C; T6(T85) for Tamb -20°C to 50°C

Connection

- C IP68 Sealed unit with cable

Cable Length

- 6 6m cable
- 15 15m cable
- 30 30m cable
- 50 50m cable

Mounting Accessories

- X Not Required
- CS Cable Suspension on end cap

Software Options

- X Not Required

AWRT 30 T 6 TB 20 X C 6 X X



Sultan Integral 3" and 3.5"

Model

- AWI2 Integral 2 Wire, No relays, Modbus
- AWI234 Integral 2 / 3 / 4 Wire, 2 relays, Modbus

Housing

- S Valox 357U

Power Supply

- B 12-30VDC
- U¹ 12-30VDC and 90-260VAC

Transducer Frequency

- 30 30kHz for applications up to 11m for 2" and 15m for 3" (Cone required⁶)
- 20 20kHz for applications up to 20m, available in 3" only (Cone required⁶)
- 15 15kHz for applications up to 30m, available in 3" only (Cone required⁶)
- 10 10kHz for applications up to 40m, available in 3.5" only (Cone required⁶)
- 09 9kHz for Positioning / Position Slave applications up to 180m (Cone required⁶)
- 05 5kHz for applications up to 60m, available in 3.5" only (Cone required⁶)
- 04 4kHz for Positioning / Position Slave applications up to 180m (Cone required⁶)

Process Temperature - Facing material selection

- S² Polyolefin 80°C (176°F)
- T³ Teflon 80°C (176°F)
- Y⁴ Titanium 80°C (176°F)

Transducer Housing Material

- 4 Polypropylene

This option is no longer available

- X Option no longer available

This option is no longer available

- X Option no longer available

Additional Communication

- S¹ No additional communications (5 Relays, Modbus)
- X 4-20mA analogue
- H⁵ 4-20mA analogue with HART 2 wire
- I¹ 4-20mA analogue with HART Isolated 4 wire
- A Profibus PA
- F Foundation Fieldbus

Approval Standard

- X Not Required
- i0⁵ IECEx Zone 0 Ex ia IIA T4 IP67 Tamb -20°C to 70°C
- A0⁵ ATEX Grp II Cat 1 GD IP67 EEx ia IIA T4
- i20⁵ IECEx Zone 20 DIP A20 TA85C IP68 Tamb -20°C to 75°C
- A20⁵ ATEX Grp II Cat 1 D T85°C IP67 Tamb -20°C to 75°C
- A22 ATEX Grp II Cat 3 GD T85°C IP67 Tamb -40°C to 70°C

Software Options

- X Not Required

¹ Model AWI234 only

² Transducer Frequency 04, 05, 09, 10 only

³ Transducer Frequency 10, 15, 20, 30 only

⁴ Transducer Frequency 15 only

⁵ Model AWI2 only. Communication Option W, X, H only

⁶ See Transducer / Cone / Flange combination table

AWI234 S U 10 S 4 X X X X X



Sultan Integral 2”

Model

- AWI2 Integral 2 Wire, No relays, 12-30VDC only, Modbus
- AWI234 Integral 2 / 3 / 4 Wire, 2 relays, Modbus

Housing

- S Valox 357U

Power Supply

- B 12-30VDC
- U¹ 12-30VDC and 90-260VAC

Transducer Frequency

- 50 50kHz for liquid applications up to 5m (Cone required⁶)
- 40 40kHz for liquid applications up to 7m (Cone required⁶)
- 30 30kHz for liquid applications up to 11m (Cone required⁶)

Process Temperature - Facing material selection

- T Tefzel 80°C (176°F)

Transducer Housing Material

- 6 Tefzel

Thread Standards

- TB BSP
- TN NPT

Mounting Thread Sizes

- 20 2” thread

Additional Communication

- S¹ No additional communications (5 Relays, Modbus)
- X 4-20mA analogue
- H² 4-20mA analogue with HART 2 wire
- ^1¹ 4-20mA analogue with HART Isolated 4 wire
- A Profibus PA
- F Foundation Fieldbus

Approval Standard

- X Not Required
- i0³ IECEx Zone 0 Ex ia IIA T4 IP67 Tamb -20°C to 70°C
- A0³ ATEX Grp II Cat 1 GD IP67 EEx ia IIA T4
- i20³ IECEx Zone 20 DIP A20 TA85C IP68 Tamb -20°C to 75°C
- A20³ ATEX Grp II Cat 1 D T85°C IP67 Tamb -20°C to 75°C
- A22 ATEX Grp II Cat 3 GD T85°C IP67 Tamb -40°C to 70°C

Software Options

- X Not Required

¹ Model AWI234 only

² Model AWI2 only

³ Model AWI2 only. Communication Option W, X, H only

⁶ See Transducer / Cone / Flange combination table

AWI234 S U 40 T 6 TB 20 X X X



Flange Selection

F Flange

Dimension Standard

- A ANSI²
- D DN²
- J JIS²

Flange Sizes

- 2N Matches 2" NPT threaded units
- 2B Matches 2" BSP threaded units
- 3 3" acoustically isolated flange
- 4 4" acoustically isolated flange
- 6 6" acoustically isolated flange
- 8 8" acoustically isolated flange
- 10 10" acoustically isolated flange

Flange Mounting Position¹

- A Cone Mounted (standard)
- C Angled flange piece only

Flange Material

- 4 Polypropylene

F A 4 A - 4

Cone Selection

C Focaliser Cone

Cone Type¹

- 02N C04 cone for 2" NPT transducer
- 02B C04 cone for 2" BSP transducer
- 04 4" cone for 20kHz and 3" 30kHz transducers
- 08-15 8" cone for 15kHz
- 08-10 8" cone for 10kHz
- 10-15 10" cone for 15kHz
- 10-10 10" cone for 10kHz and 9kHz
- 10-05 10" cone for 5kHz and 4kHz

Cone Material

- 4 Polypropylene
- 7A Carbon Fibre. Includes matching ANSI Flange (4", 8" or 10")
- 7D Carbon Fibre. Includes matching DN Flange (4", 8" or 10")
- 7J Carbon Fibre. Includes matching JIS Flange (4", 8" or 10")
- 8 Polyurethane

C 04 - 4

Additional Flange Options¹

- FA8A-4-C4** 8" ANSI, polypropylene
- FA10A-4-C4** 10" ANSI, polypropylene
- FA6D50-4** 6" ANSI, polypropylene
- FA8D50-4** 6" ANSI, polypropylene
- FA10D50-4** 6" ANSI, polypropylene

Additional Cone Options¹

- C04-4-ZOD90** C04-4 trimmed to fit 90mm ID nozzle.
- C03-4-Z** Cone and coupling to fit 72mm ID nozzle for 20kHz and 30kHz (T4).

¹ Important: See Transducer / Cone / Flange combination table for valid part combinations

² See 'Flange Dimension Standards' table for full Flange specification



Transducer / Cone / Flange Combination Table

• Each line represents fitting combinations. Flange Dimension Standard A, D or J replaces underscore (_) position

Transducer	Cone	Flange Option 1	Flange Option 2	Flange Option 3	Flange Option 4
50 / 40kHz	C02	F_3A	F_4A		
30kHz (T6)	C02	F_3A	F_4A		
30kHz (T4)	C03-4-Z	F_3A			
	C04	F_3A	F_4A	F_6A	F_8A-4-C4
Back Cap Mount (TB30)		F_4A	FA6A		
20kHz	C03-4-Z	F_3A			
	C04	F_3A	F_4A	F_6A	F_8A-4-C4
Back Cap Mount (TB30)		F_4A	F_6A		
15kHz	C04	F_4A	F_6A		
	C08	F_8A	F_10A	F_6D50-4	
	C10	F_8A	F_10A	F_6D50-4	
Back Cap Mount (TB30)		F_4A	F_6A		
9 / 10kHz	C08	F_8A	F_10A	F_6D50-4	
	C10	F_8A	F_10A	F_6D50-4	
Back Cap Mount (TB50)		F_6D50-4	F_8D50-4	F_10D50-4	
4 / 5kHz	C08	F_8A	F_10A	F_6D50-4	
	C10	F_8A	F_10A	F_6D50-4	
Back Cap Mount (TB50)		F_6D50-4	F_8D50-4	F_10D50-4	

 Not Recommended

Accessories

HAWKLink Data Modem

Model

HLR Remote stand alone HAWKLink system

Power Supply

B 12-30VDC

U 12-30VDC and 90-260VAC

Network Type

G3 3G Autoband

Sim Card

S3 Australian Sim Card expires after 3 month

S12 Australian Sim Card expires after 12 month

X Not Required

HAWKLink USB PC connector for GosHawkII

HAWKLink-USB

Stainless Steel Sunhood

SUNHOOD

Junction Box for twin Transducer applications

AWRT-JB-01

AWRT-JB-06 (includes 6m cable)

Extra Cable (Belden 3084A)

CA-TXCC-R-C15 15m cable

CA-TXCC-R-C30 30m cable

CA-TXCC-R-C50 50m cable

CA-TXCC-R-C100 100m cable

HLR U G3 S3

Specifications

Sultan Acoustic Wave Series



Frequencies

- 4kHz, 5kHz, 9kHz, 10kHz, 15kHz, 20kHz, 30kHz, 40kHz, 50kHz

Operating Voltage

- 12-30VDC (residual ripple no greater than 100mV)
- 90-265VAC 50/60Hz
- 36-60VDC

Power Consumption

- <10VA @ 240VAC
- <3W @ 24VDC
- <6W @ 48VDC

Analog Output

- 4-20mA (750 ohms @ 24Vdc User supply, 250 ohms internally driven)

Communications

- GosHawk, HART, Modbus, Modbus over Ethernet TCP/IP, Profibus DP, DeviceNet, Foundation Fieldbus, Profibus PA. Multidrop mode can address 1-250 units over 4 wire

Relay Output

(2) Integral (5) Remote

- Form 'C' (SPDT) contacts, rated 0.5A at 240VAC non-inductive.
- All relays have independently adjustable dead bands.
- Remote fail-safe test facility for one relay.

Blanking Distance

See 'Minimum Measurement Range' section

Maximum Range

- 5m (16ft) 50kHz liquids
- 7m (22ft) 40kHz liquids
- 10m (33ft) 30kHz liquids, 5m (16ft) solids
- 20m (65ft) 20kHz liquids/slurries, 10m (33ft) solids
- 30m (98ft) 15kHz liquids/slurries, 20m (65ft) solids
- 60m (196ft) 10kHz liquids/slurries 40m (165ft) / powders/solids
- 60m (196ft) 5kHz liquids/slurries/powders/solids
- 180m (588ft) 4/9 kHz for extended range position applications

Resolution

- 1 mm (0.04") 50, 40, 30,20, 15, 10, 5kHz
- 4 mm (0.2") 9, 4kHz

Sensor Accuracy

- +/- 0.25% of measured range

Operating Temperature

- Integral System -40°C (-40°F) to 80°C (176°F)
- Remote electronics -40°C (-40°F) to 80°C (176°F)
- Remote transducer -40°C (-40°F) to 80°C (176°F)

Transducer / Amplifier Separation

- Up to 1000m using specified extension cable

Cable

- 4 conductor shielded twisted pair instrument cable.
- Conductor size dependent on cable length.
- BELDEN 3084A, DEKORON or equivalent.
- Max: BELDEN 3084A = 500m (1640 ft)
- Max: DEKORON IED183AA002 = 350m (980 ft)

Maximum Operating Pressure

- +/- 7.5 PSI (+/- 0.5 Bar)

Specifications / Approvals & Certification

Sultan Acoustic Wave Series



Beam Angle

- 7.5° without focaliser 50kHz/40kHz / 30kHz
- 4° with focaliser 50kHz/40kHz
- 6° with focaliser 30kHz/20kHz / 15kHz/10kHz/5kHz
- 10° with focaliser 9kHz/4kHz

Display

- 2 line x 12 digit alphanumeric LCD

Memory

- Non-Volatile (No backup battery required)
- >10 years data retention

Enclosure Sealing

- Integral System IP67
- Remote Electronics IP65 (NEMA 4x)
- Remote Transducer IP68

Cable Entries

- Integral: 3 x M16 Glands
- Remote: 3 x 20mm, 1 x 16mm knock outs.

Mounting

- ANSI, JIS or DIN Flange
- 4 in/100mm to 10 in/250mm
- 2in BSP Thread / NPT Thread

Typical Weight

	kg	lb
• Remote Amplifier with 6m cable	1	2.2
• Remote Amplifier with 15m cable	3	6.6
• Remote Amplifier with 30m cable	6	13.2
• Remote Amplifier with 50m cable	10	22.0

Typical Weight

Sultan Integral / Transducer with appropriate flange and cone

• 4/5kHz Transducer	13kg	28.6lb
• 9/10kHz Transducer	10kg	22lb
• 15kHz Transducer	8kg	17.6lb
• 20/30kHz (3") Transducer	3kg	6.6lb
• 2" 30/40/50kHz Transducer	1kg	2.2lb

Approvals & Certification

For queries about certification please contact techsupport@hawk.com.au

See www.hawkmeasure.com for full safety instructions and installation requirements in hazardous environments.

- IECEx Zone 0 Ex ia IIA T4 IP67 Tamb -20°C to 70°C
- ATEX Grp II Cat 1 GD IP67 EEx ia IIA T4
- IECEx Zone 1 Ex mb II IP68 T5 (Tamb -20°C to 65°C) T6 (Tamb -20°C to 50°C)
- ATEX Grp II Cat 2 GD EEx m II IP68 T5 (Tamb -20°C to 65°C) T6 (Tamb -20°C to 50°C)
- IECEx Zone 20 DIP A20 TA85C IP68 Tamb -20°C to 75°C
- ATEX Grp II Cat 1 D T85°C IP67 Tamb -20°C to 75°C
- ATEX Grp II Cat 3 GD T85°C IP67 Tamb -40°C to 70°C
- CSA Equip Class 2; Pollution deg 2; Tamb -20°C to 75°C (Ordinary Locations)
- CSA Class I; Div 1/2; Group D; Zone 0; AEx/Ex ia IIA; T4
- CSA Class II; Div 2; Group F&G; Class III; T6 T85 for Tamb -20°C to 75°C
- CSA Class II; Div 1; Group E, F&G; Ex mb II; T5(T100) for Tamb -20°C to 65°C; T6(T85) for Tamb -20°C to 50°C

Hawk Measurement Systems (Head Office)

15 - 17 Maurice Court
Nunawading VIC 3131, AUSTRALIA

Phone: +61 3 9873 4750

Fax: +61 3 9873 4538

info@hawk.com.au

Hawk Measurement

90 Glenn Street
Suite 100B, Lawrence, MA 01843, USA

Phone: +1 888 HAWKLEVEL (1-888-429-5538)

Phone: +1 978 304 3000

Fax: +1 978 304 1462

info@hawkmeasure.com

All company or product names are registered trademarks or trademarks of their respective owners.

DOC-SULTAN-MAN V1.14 0219

