

Vortex flow sensors // VVX for fluids



US version available

VVX20

Note: The US versions are separate products.
The units are not converted, but pre-configured at the factory for the respective variants.



VVX20 QuickFasten

Poka
Yoke

100 %

- Final water flow test by testing robot
- Adjustment of output signal and calibration at 3 test points
→ Traceable measurement performance
- Recording of the test data
→ Test protocols available for customers
- Traceability via serial number

µController

- Customer-specific adaptation through approx. 60 software parameters
- Software filter (optional)
→ exact flow measurement even with vibrations

Final test by testing robot

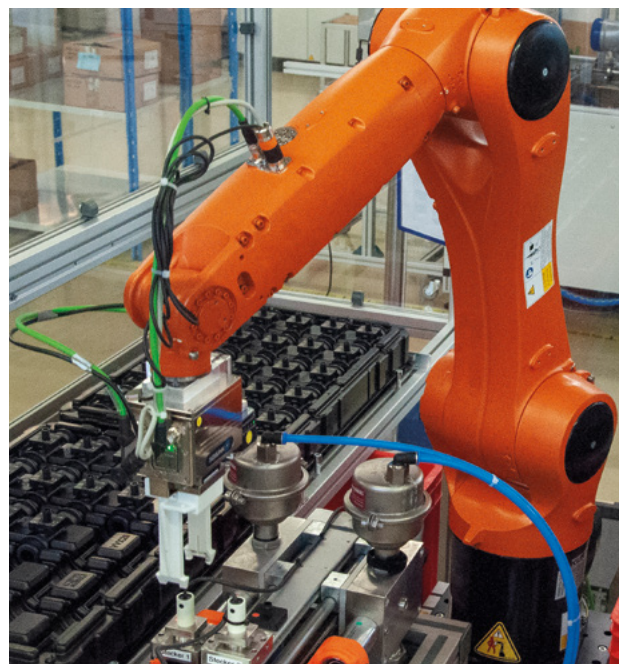

encapsulated piezoceramic sensor element



Reliable

- Piezoceramic sensor element completely encapsulated
→ no direct medium contact
→ dirt-resistant and fail-safe
- CE Marking
- OEM product developed and produced in Germany

Test reports for customers

- SIKA test labs - many qualification tests
 - Temperature shock
 - Contamination
 - and many other tests
- Test SIKA VVX in provided customer hydraulics
 - Optimization of the measurement performance in real installation situation
- Sample devices can be supplied with works test certificate

Test in provided customer hydraulics



QuickFasten

- Quick and safe plug-in connection
 - Poka Yoke
- Toolless assembly
- Form-fit connection

QuickFasten





Reliable partnership with SIKA

- More than 45 years of experience with flow sensors in heaters
- Leading heat pump manufacturers trust in SIKA Vortex flow sensors

General information on the principle of operation

Alternate vortices rotating in opposite directions are generated behind a bluff body immersed in a flow. The vortices detach from the edges of the bluff body and form a Kármán vortex street in the fluid stream. The distance between the single vortices is constant. The frequency of the vortices flowing past a sensor depends on the flow rate and is proportional to the flow. The sensor detects these vortices which are then converted to an electrical frequency signal.

- Minimal flow obstruction → low pressure drop
- Independent of the conductivity of the medium
- High long-term stability / no zero drift

Type	VVX15	VVX20	VVX25
Nominal diameter	DN 15	DN 20	DN 25
Nominal pipe size	½"	¾"	1"
Process connection	G¾-ISO 228 male, incl. O-rings	G1-ISO 228 male, incl. O-rings or QuickFasten without O-rings	G 1¼-ISO 228 male, incl. O-rings
Process connection	½" NPT	¾" NPT or QuickFasten	1" NPT
Inner diameter [mm]	Ø 13	Ø 19	Ø 25
Inner diameter [inch]	0.5	0.75	1
Medium	Water and aqueous solution		
Pressure rating	PN 10		
Pressure rating	Max. 145 psi		
Degree of protection EN 60529	IP65 and IP67 (each with attached cable socket)		
Flow measuring			
Flow range [l/min]	2...40*	5...80*	7...150*
Flow range [US gpm]	0.5...10*	1.3...21*	2...40*
Accuracy	±2 % of range*, deviations with media of higher viscosity		
Repeatability	±1 % at -20...5 °C Umgebungstemperatur ±0.5 % at 5...70 °C Umgebungstemperatur		
Repeatability	±1 % at -4...41 °F ambient temperature ±0.5 % at 41...158 °F ambient temperature		
Temperature ranges			
Medium	-20...90 °C (non-freezing)		
Medium	-4...194 °F (non-freezing)		
Ambient	-20...70 °C		
Ambient	-4...158 °F		
Electrical data			
Electrical connection	5-pin plug connector M12 x 1		
Power supply for output signal Push Pull (optional NPN) NPN 4...20 mA or 0...10 V	8...30 V DC 5 V DC 12...24 V DC		
Current consumption	< 15 mA		
Approvals			
			
 <ul style="list-style-type: none"> • Conforms to ANSI UL Std.61010-1 • Cert. to CAN/CSA C22.2 No.61010-1 			

* Test conditions:

- Test medium water
- Media temperature 20...30 °C / 68...86 °F
- Inlet pressure 7...10 bar / 102...145 psi
- Defined inlet and outlet pipes (see operating manual)

Three different versions available:

- Frequency output (1)
- Analogue 0.5...3.5 V and frequency output (1 and 2)
- Analogue 0...10 V or 4...20 mA and frequency output (1 and 3)

Frequency output 1	VVX15	VVX20	VVX25
Output signal flow	Frequency signal, square wave, pulse duty ratio 50:50, signal current max. 20 mA		
Pulse rate [1/l]	500 (optional 3...1000)	200 (optional 2...800)	100 (optional 1...500)
Pulse rate [pulses/gallon]	2000 (optional 12...4000)	750 (optional 8...3000)	400 (optional 4...2000)
Output signal temperature	Pt1000 2 wire, class B or NTC 10.74k, B 0/100 3450 or none		

Analogue output 2	VVX15	VVX20	VVX25
Output signal flow	0.5...3.5 V		
Scaling [l/min]	2...40	5...80	7...150 l/min
Scaling [US gpm]	0.5...10	1.3...21	2...40 GPM
Voltage rate → 0.5...3.5 V	0.07895 V / l/min	0.04000 V / l/min	0.02098 V / l/min
Voltage rate [V / US gpm] → 0.5...3.5 V	0.31579	0.15228	0.07895
Output signal temperature	Voltage signal 0.5...3.5 V corresponds to 0...90 °C / 32...194 °F or none		

Analogue output 3	VVX15	VVX20	VVX25
Output signal flow	0...10 V or 4...20 mA		
Scaling [l/min]	0...40	0...80	0...150
Scaling [US gpm]	0...10	0...21	0...40
Voltage rate [V / l/min] → 0...10 V	0.25000	0.12500	0.06667
Current rate [mA / l/min] → 4...20 mA	0.40000	0.20000	0.10667
Voltage rate [V / US gpm] → 0...10 V	1.00000	0.47619	0.25000
Current rate [mA / US gpm] → 4...20 mA	1.60000	0.76190	0.40000
Output signal temperature	none		

Typical pressure drop VVX15

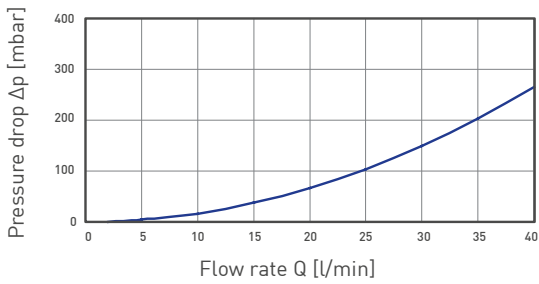

Typical pressure drop VVX15

US version

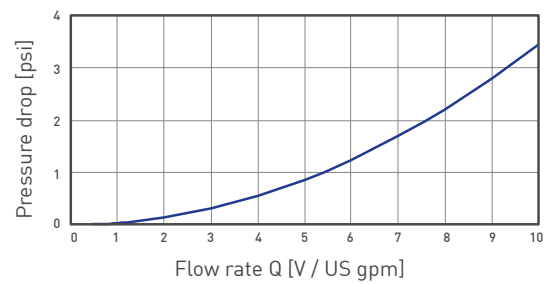

Typical pressure drop VVX20

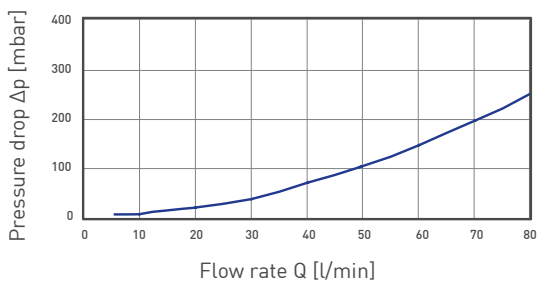

Typical pressure drop VVX20

US version

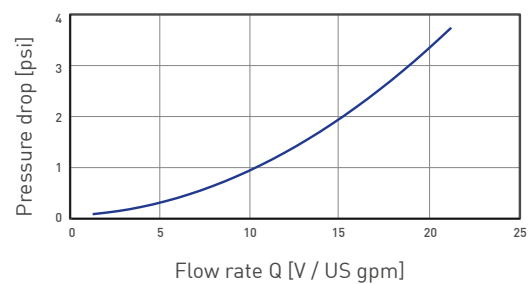

Typical pressure drop VVX25

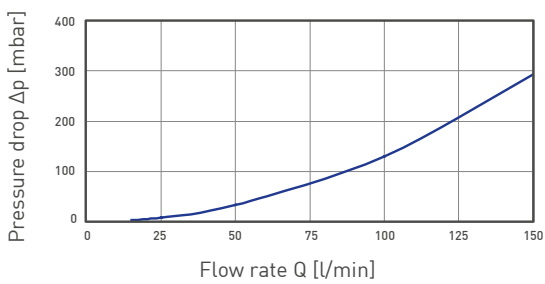

Typical pressure drop VVX25

US version

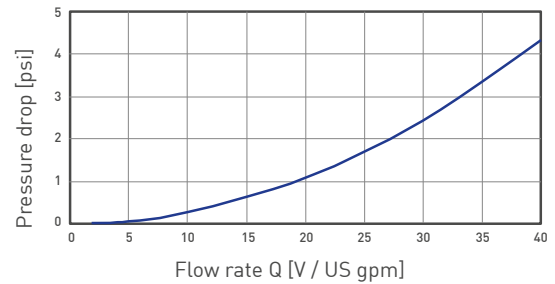

VVX20 QuickFasten

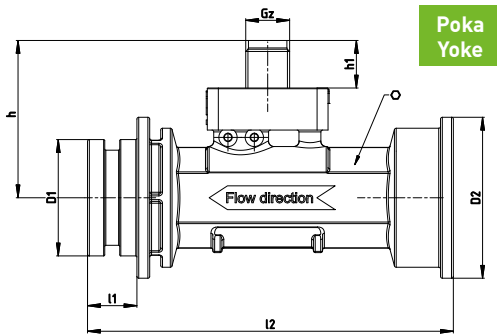

Flow direction

VVX threaded versions

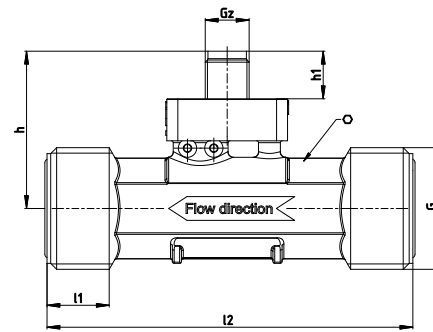

Flow direction

NPT version

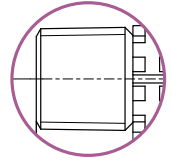

Dimensions [mm]	h	h1	D1	D2	l1	l2	G	Gz	○ Width across flats
Threaded version									
VVX15	40	13			16.5	80	G 3/4	M12 x 1	19
VVX20	43	13			16.5	100	G 1	M12 x 1	24
VVX25	46	13			16.5	95	G 1 1/4	M12 x 1	30
Quickfasten									
VVX20	43	13	31.8	44	13.5	100		M12 x 1	24
Dimensions [inch]									
Threaded version									
VVX15	1.57	0.51			0.79	3.45	1/2 - 14 NPT	M12 x 1	7.48 and 15/16"
VVX20	1.69	0.51			0.81	3.94	3/4 - 14 NPT	M12 x 1	9.45 and 1 1/8"
VVX25	1.69	0.51			0.53	3.94	1 - 11.5 NPT	M12 x 1	11.81 and 1 1/2"
Quickfasten									
VVX20	1.81	0.51	1.25	1.73	0.94	3.94			

Materials in contact with media

VVX15, VVX20, VVX25

Body /tube	PPS Fortron® 40 % glass fibre reinforced
Sensor	ETFE Tefzel®
O-rings	EPDM

Wiring

Pin assignment

The pin assignment depends on the chosen configuration of the device.

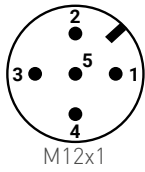

Possible pin assignments:

Pin 1: $+U_B$

Pin 2: U_{Flow} • R_{Temp} • Analog U/I • Alarm*¹

Pin 3: **GND**

Pin 4: Frequency • Analogue U/I • Alarm*¹

Pin 5: U_{Temp} • R_{Temp}

*¹ The alarm output is only possible with the corresponding firmware and has been determined during the order.

Wire the connecting cable according to your device version and the pin assignments shown on the type plate.

Supply voltage

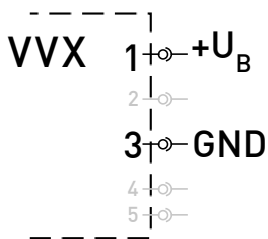

VVX with frequency output

Flow

Push-Pull*¹

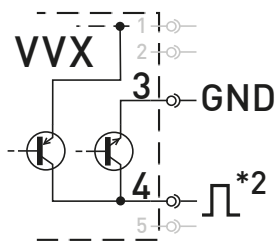

NPN Open Collector

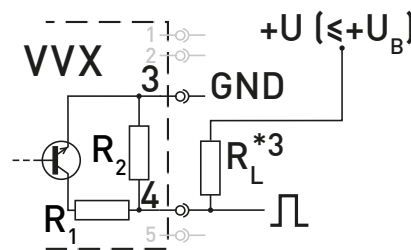

$$R1 \leq 47 \Omega / R2 \geq 10 \text{ k}\Omega$$

PNP Open Collector

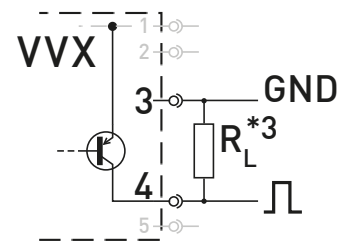

*¹: Not at 5 V.

*²: Do not wire the push-pull switch outputs of multiple VX devices in parallel.

*³: Recommended pull-up / pull-down resistance $R_L \sim 5 \text{ k}\Omega$.

VVX with temperature (optional)

NTC / Pt 1000

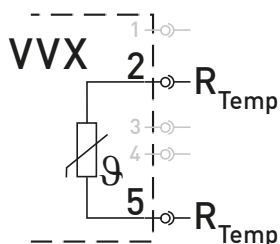

VVX with analogue output 0.5...3.5 V (optional)

Flow U_{Flow}

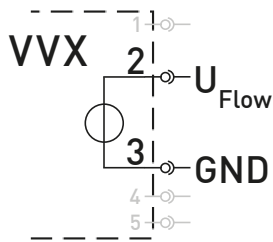

Temperature U_{Temp}

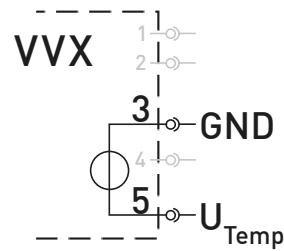

VVX with voltage 0...10 V or current output 4...20 mA (optional)

Flow

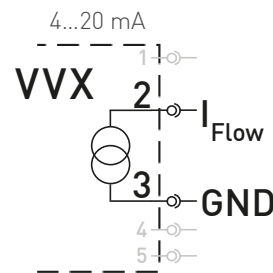
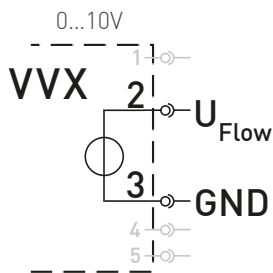

Use of frequency output and optional functions

The frequency output can be wired together with the optional functions. However, not every combination is possible. In principle, the pins 2, 4 and 5 can only be assigned with one function at a time. A multiple assignment is not possible. The wiring results from an overlay of the circuit diagrams of the corresponding functions, as shown in the two following examples.

Flow NPN + Analogue 0.5...3.5V

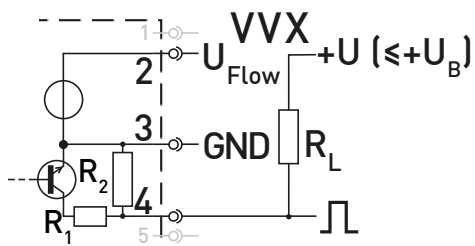

$$R1 \leq 47 \Omega / R2 \geq 10 \text{ k}\Omega$$

Recommendation for resistance $R_L \sim 5 \text{ k}\Omega$

Flow Push-Pull + current 4...20 mA

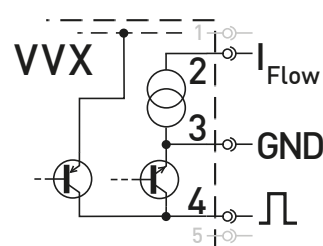

Version frequency output

Order code						
Nominal diameter						
WX15, DN 15 G $\frac{3}{4}$	WXA1S		A			514
WX20, DN 20 QuickFasten	WXC9S		B			52P
WX20, DN 20 G1	WXC9S		B			527
WX25, DN 25 G1 $\frac{1}{4}$	WXB2S		B			516
Power supply						
8...30 V DC		G			1	
5 V DC		N			2	
Output signal temperature						
Pt1000				RRRP		
NTC 10.74K				RRRN		
None				0000		
Example order number	WXA1S	G	A	RRRP	1	514

Order code						
Nominal pipe size						
WX15, $\frac{1}{2}$ "	WXAAE		1			51C
WX20, $\frac{3}{4}$ " QuickFasten	WXCCE		K			52P
WX20, $\frac{3}{4}$ "	WXCCE		K			528
WX25, 1"	WXBBE		2			51E
Power supply						
8...30 V DC		G			1	
5 V DC		N			2	
Output temperature sensor						
Pt1000				RRRP		
NTC 10.74K				RRRN		
None				0000		
Example order number	WXAAE	N	1	RRRP	1	51C

Version analogue output (0.5...3.5 V) and frequency output

Order code					
Nominal diameter					
WX15, DN 15 G $\frac{3}{4}$	WX15SNA	U1			514
WX20, DN 20 QuickFasten	WX20SNA	UC			52P
WX20, DN 20 G1	WX20SNA	UC			527
WX25, DN 25 G1 $\frac{1}{4}$	WX25SNA	U2			516
Output signal temperature					
0.5...3.5 V		U1			
none		00			
Power supply					
8...30 V DC				1	
5 V DC				2	
Example order number	VVXA1SNA	U1	U1	1	514

Order code					
Nominal pipe size					
WX15, $\frac{1}{2}$ "	WX15AEN1UA				51C
WX20, $\frac{3}{4}$ " QuickFasten	WX20AEN1UA				52P
WX20, $\frac{3}{4}$ "	WX20AEN1UH				528
WX25, 1"	WX25AEN2UB				51E
Output temperature sensor					
0.5...3.5 V		U1			
None		00			
Power supply					
8...30 V DC				1	
5 V DC				2	
Example order number	VVXAEN1UA	U1	1	1	51C

Version analogue output (0...10 V or 4...20 mA) and frequency output

Order code		
Nominal diameter		
WX15, DN 15 G $\frac{3}{4}$	VXA1SGA	K003514
WX20, DN 20 QuickFasten	WXC9SGB	N00352P
WX20, DN 20 G1	WXC9SGB	N003527
WX25, DN 25 G1 $\frac{1}{4}$	WXB2SGB	L003516
Output signal flow		
0...10 V		V
4...20 mA		A
Example order number	VVXA1SGA	V K003514

Order code		
Nominal pipe size		
WX15, $\frac{1}{2}$ "	WXAAEN1	P00351C
WX20, $\frac{3}{4}$ " QuickFasten	WXCCENK	Q00352P
WX20, $\frac{3}{4}$ "	WXCCENK	Q003528
WX25, 1"	WXBBEN2	S00351E
Output signal flow		
0...10 V		V
4...20 mA		A
Example order number	VVXAASN1	V P00351C

Order code	
Service - Test in the test bench	Order number
Tests in provided customer hydraulics including a test report Operation with SIKA test bench pump Operation with provided customer pump	WXTESTREPORT01 WXTESTREPORT02
Works calibration certificate for sample devices	WXWPS01

Order code					
Type	Accessories		Length [m]	Length [ft]	Order number
VVX15		Connection cable with 5 pin cable socket	1		XVWX040
VVX20		M12 x 1, angle type molded lead 5 x 0.34 mm ² ,	2		XVWX051
VVX25		sheathing material PVC, (Tmax = 80 °C / 176 °F),	3		XVWX039
		Pins: 1=brown, 2=white, 3=blue, 4=black, 5=grey,	5		XVWX041
		UL approval on request	10		XVWX042
		UL approval		10	XVWX017
		UL approval		16	XVWX018
		UL approval		33	XVWX019
		Connection cable with 5 pin cable socket	1.5	10	XVWX065
		M12 x 1, molded lead 5 x 0.34 mm ² , sheathing material PVC, 4 pin Molex MicroBlade wire-to-board housing, (Tmax = 80 °C / 176 °F), Pins: 1=brown, 2=white, 3=blue, 4=n.c., 5=black			
Type	Accessories	Scope of delivery: 1 piece each	Order number		Order number
VVX15		Screw coupling G 1/2, brass	BVWX1007		
		Soldering coupling Ø 15 mm, brass	BVWX1008		
VVX20		O-ring for QuickFasten, EPDM*	XVWX061		XVWX061
		Joint clip QuickFasten, stainless steel*	XVWX052		XVWX052
		Soldering coupling for QuickFasten, inlet side	BVWX1012		BVWX1012
		Soldering coupling for QuickFasten, outlet side	BVWX1011		BVWX1011
		Screw coupling G 1*, brass, compatibility type	BVWX1021		
VVX25		Screw coupling R1, brass	BVWX1003		
		Soldering coupling Ø 28 mm, brass	BVWX1004		
		Bonding coupling Ø 25 mm, PVC	BVWX1005		
		Screw coupling G 1, stainless steel 1.4571	BVWX1006		
		Screw coupling G 1 1/4*, brass, compatibility type	BVWX1022		

* Two pieces are required for the assembly