



COMELETRIC

Specialized rotary and control switches

series R20-DR20





| | |
|---|-------|
| R20 General Information R20 Informazioni Generali..... | 3-4 |
| R101 Model Modello R101..... | 5 |
| R102 Model Modello R102..... | 6 |
| R103 Model Modello R103..... | 7 |
| R126 Model Modello R126..... | 8 |
| R110 Model Modelli R110..... | 9 |
| R141 Model Modello R141..... | 10 |
| R104 PUSH / R107 PULL Model Modello R104 PUSH / R107 PULL..... | 11 |
| SR109 Model Modello R109..... | 12 |
| Switch functions and configurations Funzione e configurazione commutatori..... | 13-34 |
| BR001 Model Modello BR001..... | 35-36 |
| Front dimensions Dimensione frontali..... | 37-38 |
| DR110 / DR115 Model Modello DR110 / Modello DR115..... | 39-40 |
| DS functions and configurations Funzione e configurazione manipolatori..... | 41-45 |
| Accessories Accessori..... | 46 |
| Technical data Dati tecnici..... | 47-48 |
| Custom made models Modelli speciali..... | 49 |



Double bridge Rotor contact Knife type
Fixed contacts with self-cleaning effect.
Contatto mobile a doppio ponte contatti fissi
a coltello con effetto strisciante autopulente.

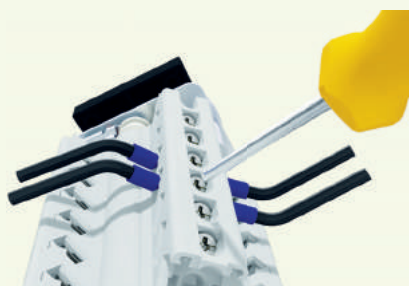

IP20 terminal screw with two entries.
Easy access to screws even
when the switch is wired.
Morsetto con protezione IP20 a doppio
ingresso. L'accesso alla vite garantito anche
a commutatore cablato.



Terminal easy to access from the rear of the
switch thanks to the inclined screw 45°.
Morsetto con viti inclinate a 45° facilità di accesso
al morsetto anche dal retro del commutatore.

R20 OFFERS ONLY ADVANTAGES

■ The switches/discrepancy switches "R20-DR20" have special characteristics that make them very different from the normal switches on the market.
Listed below are some of the many advantages they provide.

■ Contact system with self-cleaning action on both sides of contact, suitable for being used in highly aggressive environments, with presence of high percentage of saline dust and corrosive agents.

■ High resistance to shock and vibration, due to the clip and blade contact design.

■ Terminals with protection IP20 according to IEC 60529 with two entries.

■ Easy access to the screws of each terminal even when the switch is wired.

■ High mechanical strength, shaft and main structure in zinc plated steel, suitable for tropical climates.

■ Terminals screws at 45° for ease of access.

■ Last generation polymer with high mechanical strength and excellent electrical characteristics.
Self-extinguishing UL94V0.

R20 OFFRE SOLO VANTAGGI

■ I commutatori / manipolatori serie "R20-DR20" hanno caratteristiche particolari che li rendono molto differenti dai commutatori comunemente in commercio, elenchiamo di seguito quali sono ed i vantaggi che garantiscono.

■ Sistema contatto strisciante con effetto autopulente su entrambe le superfici di contatto particolarmente idonei ad essere utilizzati in ambienti altamente aggressivi presenza di polvere alto tasso salino ecc.

■ Elevata resistenza a Shock e Vibrazioni. Poiché il contatto fisso è posizionato tra le due lame, il contatto viene premuto su una lama nel caso la forza sull'altra diminuisca.

■ Morsetti con protezione IP20 in conformità alla normativa IEC 60529 con doppio ingresso.

■ Accesso alla vite del singolo morsetto anche a commutatore cablato per facilitare le operazioni di manutenzione.

■ Elevata robustezza meccanica, albero e struttura portante interamente in acciaio zincato elettroliticamente, idoneo ad essere montato anche in zone tropicali.

■ Morsetti con viti inclinate a 45° per accessi difficoltosi (facilità di accesso al morsetto anche dal retro del commutatore).

■ Tecnopolimero di ultima generazione con ottima resistenza meccanica, elevate caratteristiche elettriche ed autoestinguento UL94V0.

■ Wide range of accessories available.

■ Captive plus/minus terminal screws M3.5.

■ Terminals supplied opened for fast and easy installation.

■ Double choice of location of the cables. Possibility of wiring horizontally or vertically on a single model of switch.

■ Numbered plastic cover, customizable and replaceable in case of failure without removing the wires to the switch.

■ Geometric body insulation allows economizing space allowing close mounting of switches.

■ A wide range of realizable switching schemes.

■ Same parts used for base or panel mounting (upside down mounting).

■ Up to 23 packets of contacts assembled in a single switch.

■ 2/3 positions switch with the possibility of an internal common (avoids external bridges).

■ Ampia gamma di accessori disponibili.

■ Vite M3.5 con cavaliere serrafilo autosollevante e viti captive taglio +/-.

■ Terminali forniti aperti per velocizzare le operazioni di cablaggio.

■ Doppia scelta di ubicazione dei cavi con possibilità di cablaggi verticali ed orizzontali in un unico commutatore.

■ Tegolino con numerazione morsetti personalizzabile e sostituibile in caso di errore senza scablare il commutatore.

■ Geometria dell'isolante permette una economicizzazione degli spazi permettendo il montaggio ravvicinato dei commutatori.

■ Ampia gamma di schemi elettrici realizzabili

■ Stesse parti utilizzate per fissaggio base o fissaggio retroquadro (montaggio ribaltato).

■ Fino a 23 pacchi di contatti assemblati in un unico commutatore.

■ Commutatori a 2/3 posizioni con possibilità di comune interno (evita di eseguire ponti esterni).



Horizontal Wiring
Cablaggio orizzontale dei cavi.



Vertical Wiring
Cablaggio verticale dei cavi

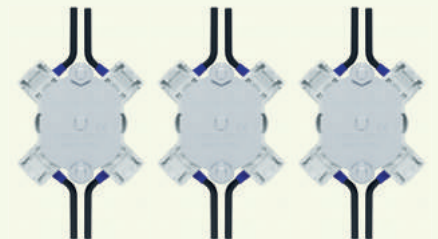

Double access to terminals allows close mounting of switches.
Possibilità di montaggio ravvicinato dei commutatori grazie al morsetto con doppia accessibilità.

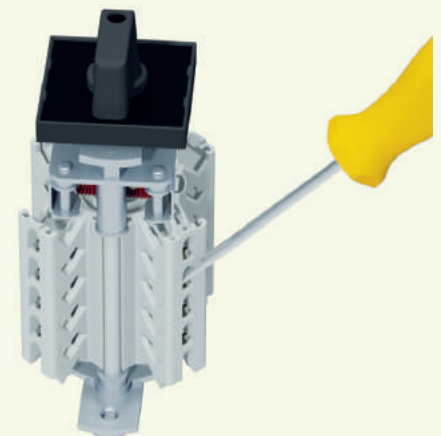

Same parts used for base or panel mounting (upside down mounting).
Per il Commutatore Base Mounting vengono utilizzate le medesime parti ma montate up-side down

R101 Model:

It can have from 2 to 8 positions fixed or with automatic return.

It may be supplied with frontplate size 48x48mm (Q4) or 64x64mm (Q7) Standard Type or Padlockable.

Realizza da 2 a 8 posizioni sia fisse che con molla di ritorno.

Può essere fornito con mostrina frontale 48x48mm (Q4) o 64x64mm (Q7) in versioni standard o Lucchettabili.

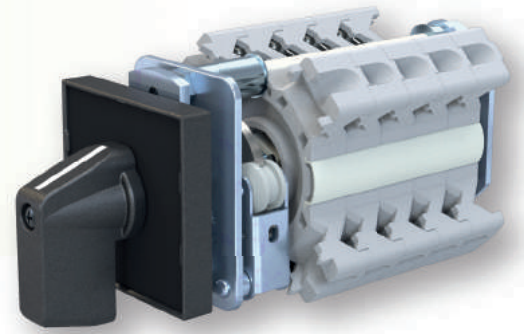

Dimensions

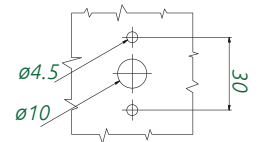
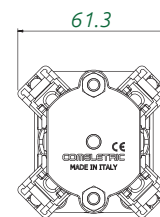
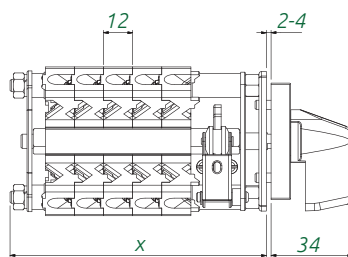
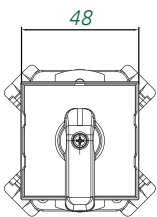

| N° of packets | 1 | 2 | 3 | 4 | 5 | 6 | 7 | 8 | 9 | 10 | 11 | 12 | 13 | 14 | 15 |
|---------------|----|----|----|-----|-----|-----|-----|-----|-----|-----|-----|-----|-----|-----|-----|
| Length (mm) | 69 | 81 | 93 | 105 | 117 | 129 | 141 | 153 | 165 | 177 | 189 | 201 | 213 | 225 | 237 |

Max 23 p.

R101 Frontplates R101 Mostrine

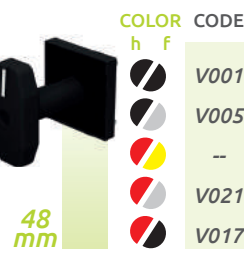
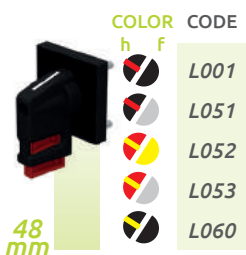
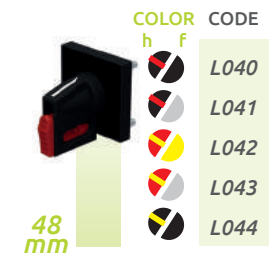
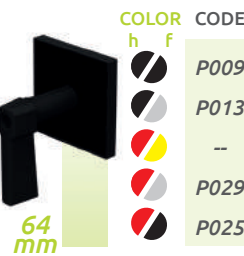
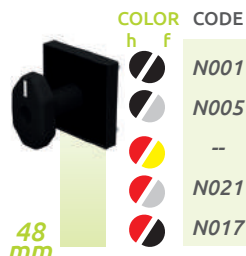
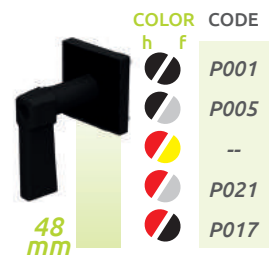
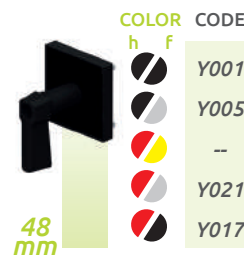
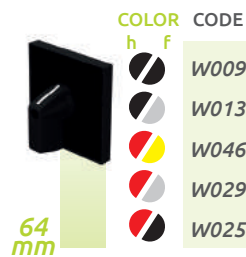
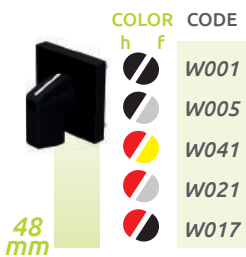

h=handle; f=frontplate
h=manopola; f=mostrina
Frontplate dimension on page 37/38
Dimensioni frontali a pag. 37/38

R102 Model:

Key Operated rotary switch.
Available with keys equal to each other and up to 200 different combinations.

Commutatore con operatore a chiave
Disponibile con chiavi uguali tra loro e fino a 200 combinazioni diverse tra loro.

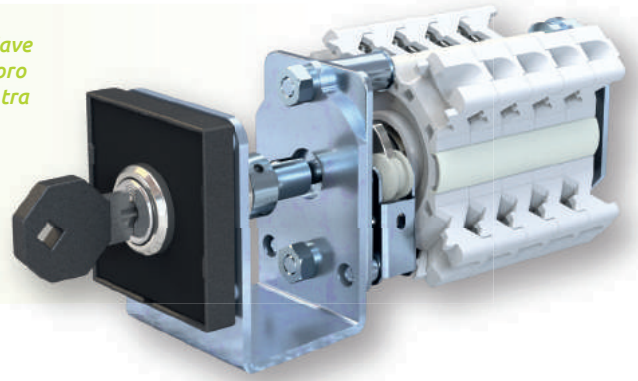

Dimensions

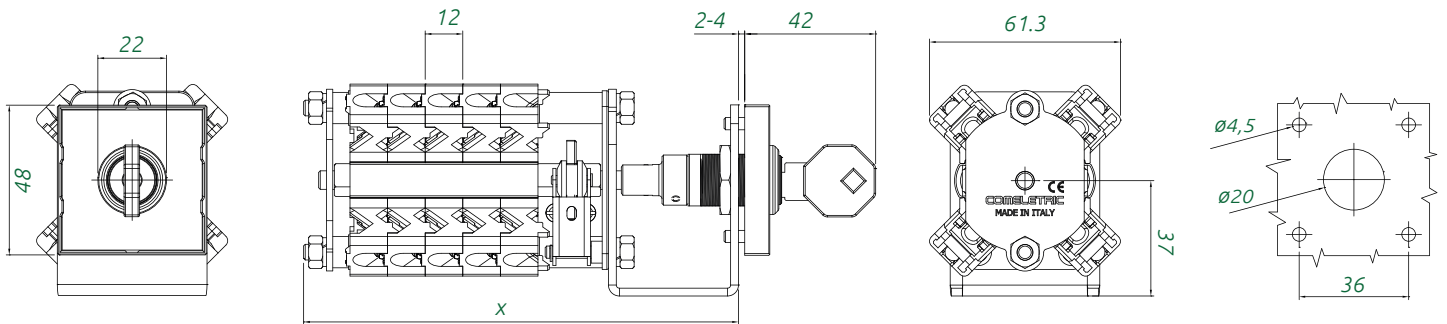

Panel Drilling

| N° of packets | 1 | 2 | 3 | 4 | 5 | 6 | 7 | 8 |
|---------------|-----|-----|-----|-----|-----|-----|-----|-----|
| Length (mm) | 102 | 114 | 126 | 138 | 150 | 162 | 174 | 186 |

R102 Frontplates R102 Mostrine

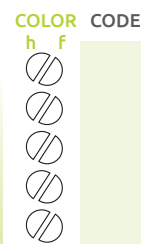
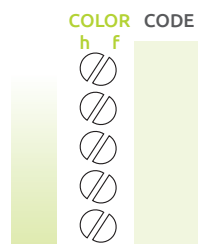
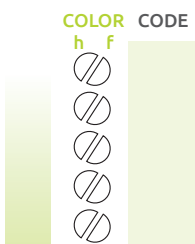
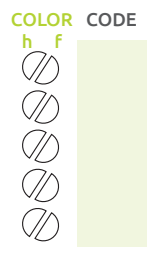
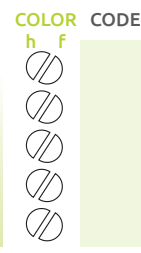

h=handle; f=frontplate
h=manopola; f=mostrina
Frontplate dimension on page 37/38
Dimensioni frontali a pag. 37/38

R103 Model:

Key Lock rotary switch.

Available with keys, that can be both equals or different one from the other (up to 500 different numbers).
MASTER KEY System is also available.

Commutatore con serratura di blocco.
Disponibile con chiavi uguali tra loro o fino a 500 combinazioni diverse tra loro.

Disponibile anche con MASTER KEY.

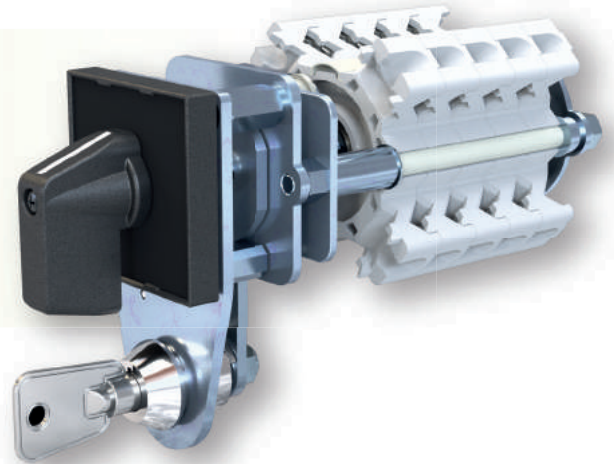

Dimensions

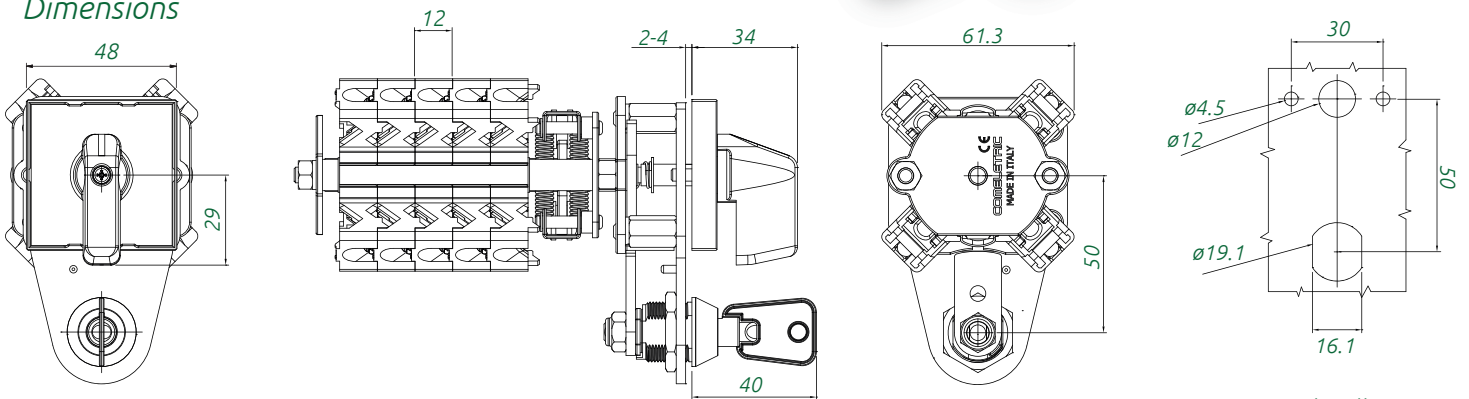

Panel Drilling

| N° of packets | 1 | 2 | 3 | 4 | 5 | 6 | 7 | 8 | 9 | 10 | 11 | 12 | 13 | 14 | 15 |
|---------------|----|-----|-----|-----|-----|-----|-----|-----|-----|-----|-----|-----|-----|-----|-----|
| Length (mm) | 89 | 101 | 113 | 125 | 137 | 149 | 161 | 173 | 185 | 197 | 209 | 221 | 233 | 245 | 257 |

Max 23 p.

R103 Frontplates R103 Mostrine

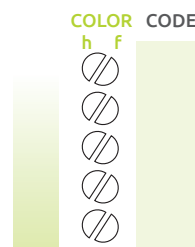
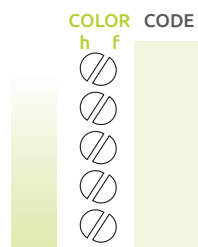
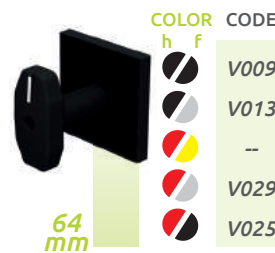
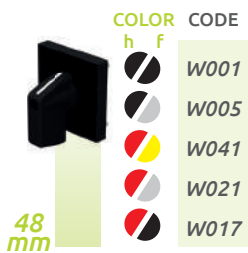

h=handle; f=frontplate
h=manopola; f=mostrina
Frontplate dimension on page 37/38
Dimensioni frontali a pag. 37/38

R126 Model:

The Mechanical trip Indicator shows the indication of the last given command.

Il dispositivo meccanico di avvenuta manovra indica l'ultimo comando effettuato dal commutatore.

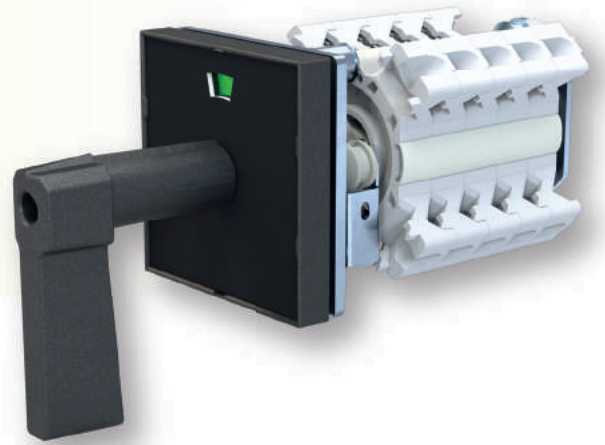

Dimensions

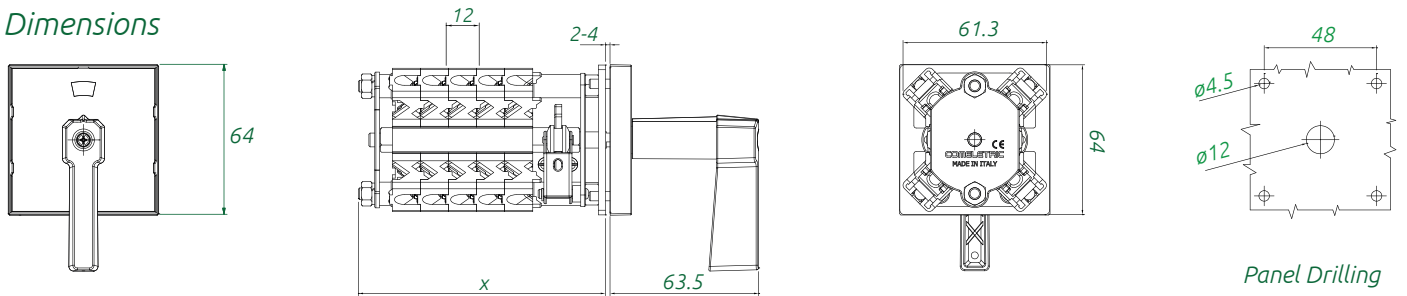

| N° of packets | 1 | 2 | 3 | 4 | 5 | 6 | 7 | 8 | 9 | 10 | 11 | 12 | 13 | 14 | 15 |
|---------------|----|----|----|-----|-----|-----|-----|-----|-----|-----|-----|-----|-----|-----|-----|
| Length (mm) | 69 | 81 | 93 | 105 | 117 | 129 | 141 | 153 | 165 | 177 | 189 | 201 | 213 | 225 | 237 |

Max 23 p.

R126 Frontplates R126 Mostrine

COLOR CODE

h f

- S016
- S017
- S018
- S019
- S020

64 mm

COLOR CODE

h f

- S021
- S022
- S023
- S024
- S025

64 mm

COLOR CODE

h f

- L012
- L061
- L062
- L063
- L064

64 mm

COLOR CODE

h f

- L005
- L065
- L007
- L030
- L066

64 mm

COLOR CODE

h f

- V034
- V036
- V037
- V038
- V039

64 mm

COLOR CODE

h f

- P033
- P034
- P035
- P036
- P037

64 mm

COLOR CODE

h f

-
-
-
-

h=handle; f=frontplate
 h=manopola; f=mostrina
 Frontplate dimension on page 37/38
 Dimensioni frontali a pag. 37/38

R110 Models:

Switch with removable handle is mainly used for Safety controls.

Commutatore con manopola asportabile adatto per comandi di sicurezza.

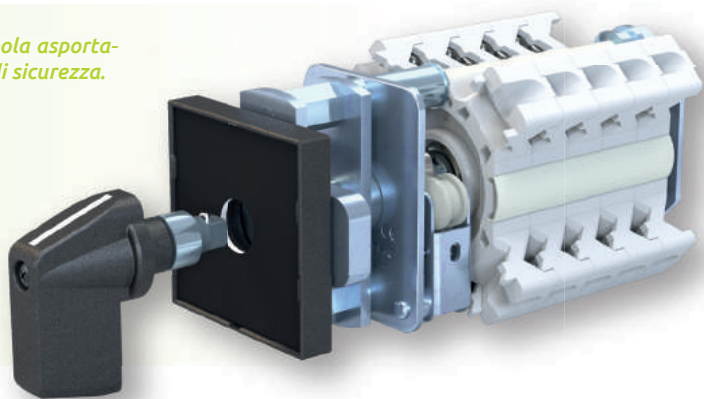

Dimensions

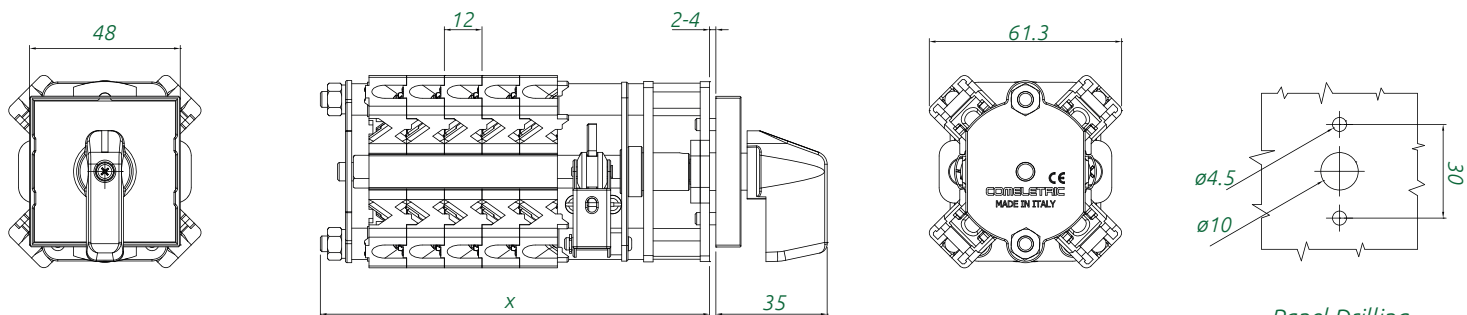

| N° of packets | 1 | 2 | 3 | 4 | 5 | 6 | 7 | 8 | 9 | 10 | 11 | 12 |
|---------------|----|-----|-----|-----|-----|-----|-----|-----|-----|-----|-----|-----|
| Length (mm) | 89 | 101 | 113 | 125 | 137 | 149 | 161 | 173 | 195 | 197 | 209 | 221 |

Max 23 p.

R110 Frontplates R110 Mostrine

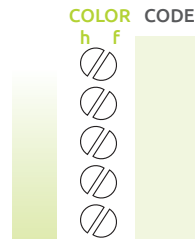
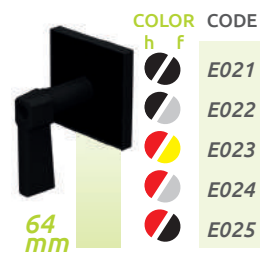
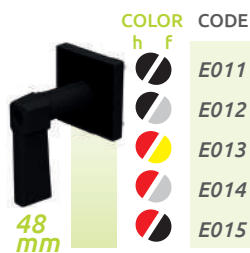

h=handle; f=frontplate
h=manopola; f=mostrina
Frontplate dimension on page 37/38
Dimensioni frontali a pag. 37/38

R141 Model:

Switch suitable for fitting at the bottom of the panel.
Access to screw from the front of the switch.

Commutatore idoneo al montaggio sul fondo del quadro.
L'accesso alle viti avviene dal fronte del commutatore.

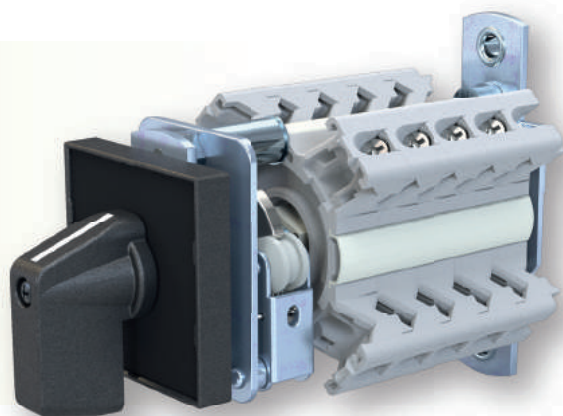

Dimensions

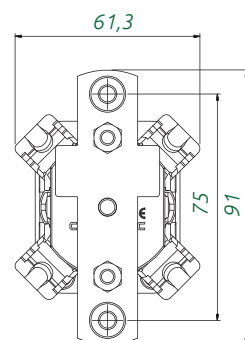
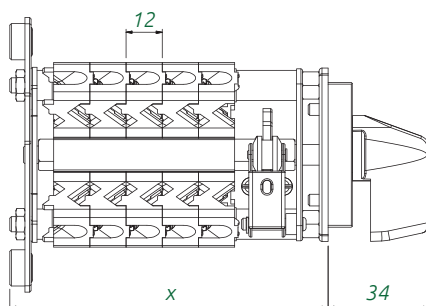
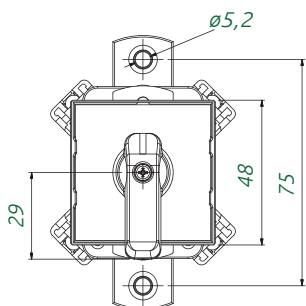

| N° of packets | 1 | 2 | 3 | 4 | 5 | 6 | 7 | 8 | 9 | 10 | 11 | 12 |
|---------------|----|----|----|-----|-----|-----|-----|-----|-----|-----|-----|-----|
| Length (mm) | 70 | 82 | 94 | 106 | 118 | 130 | 142 | 154 | 166 | 178 | 190 | 202 |

R141 Frontplates R141 Mostrine

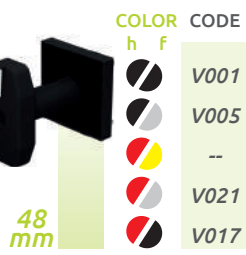
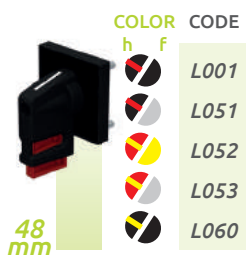
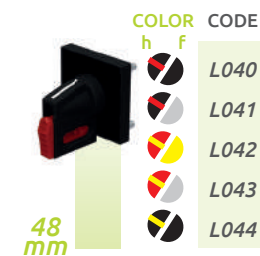
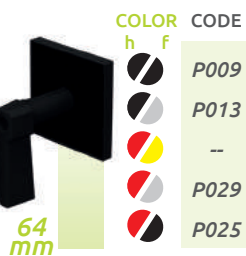
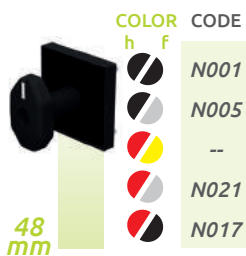
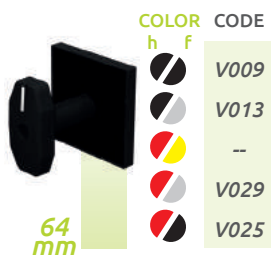
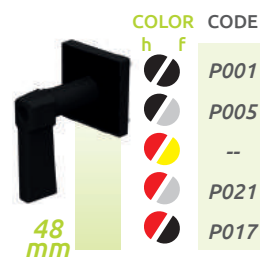
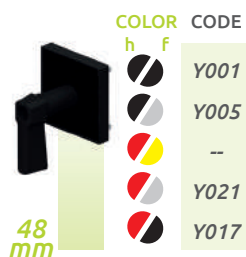
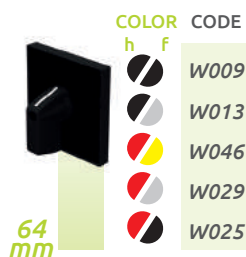

h=handle; f=frontplate
h=manopola; f=mostrina
Frontplate dimension on page 37/38
Dimensioni frontali a pag. 37/38

Models: **R104** push to operate **R107** pull to operate

This Switch is mainly used to avoid involuntary operations. It can be handled only by **PUSHING (R104)** or **PULLING (R107)** the knob of the switch.

Questo dispositivo di sicurezza serve per evitare manovre accidentali. Il commutatore può essere manovrato solamente **PREMENDO (R104)** o **TIRANDO (R107)** la manopola del commutatore.

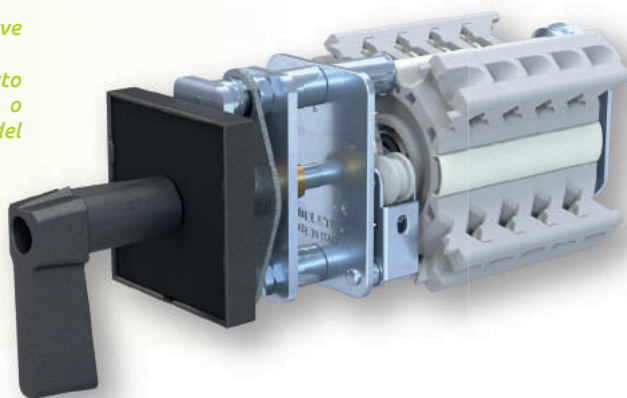

Dimensions

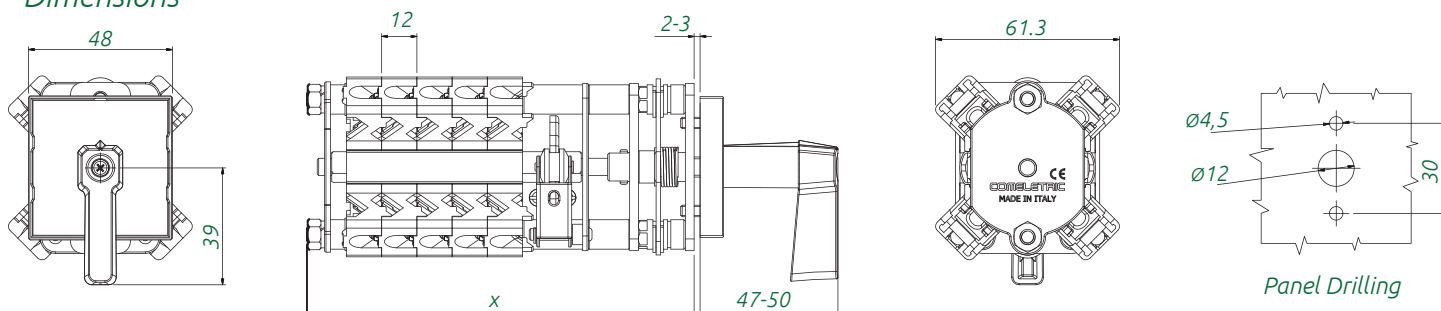

| N° of packets | 1 | 2 | 3 | 4 | 5 | 6 | 7 | 8 | 9 | 10 | 11 | 12 |
|---------------|----|-----|-----|-----|-----|-----|-----|-----|-----|-----|-----|-----|
| Length (mm) | 98 | 110 | 122 | 134 | 176 | 158 | 171 | 182 | 194 | 206 | 218 | 230 |

R104 / R107 Frontplates R104 / R107 Mostrine

48 mm

| COLOR | CODE |
|-------|------|
| h f | |
| | Z001 |
| | Z017 |
| | -- |
| | Z017 |
| | -- |

48 mm

| COLOR | CODE |
|-------|------|
| h f | |
| | Z009 |
| | Z041 |
| | -- |
| | Z025 |
| | Z049 |

64 mm

| COLOR | CODE |
|-------|------|
| h f | |
| | Z084 |
| | Z085 |
| | Z086 |
| | Z087 |
| | Z088 |

48 mm

| COLOR | CODE |
|-------|------|
| h f | |
| | Z057 |
| | Z080 |
| | Z081 |
| | Z082 |
| | Z083 |

64 mm

| COLOR | CODE |
|-------|------|
| h f | |
| | Z089 |
| | Z090 |
| | Z091 |
| | Z092 |
| | Z093 |

| COLOR | CODE |
|-------|------|
| h f | |
| | |
| | |
| | |
| | |
| | |

| COLOR | CODE |
|-------|------|
| h f | |
| | |
| | |
| | |
| | |
| | |

h=handle; f=frontplate
 h=manopola; f=mostrina
 Frontplate dimension on page 37/38
 Dimensioni frontali a pag. 37/38

SR109 Model:

Switch with electromagnetic interlocking device.

Allows manoeuvre after electric consent.

The switch is unblocked by exciting the circuit.

SOLENOIDS AT VOLTAGES:

24Vdc - 110Vdc - 220Vdc

other tensions on request.

Commutatore con elettromagnete di interblocco.

Permette la manovra dopo un consenso elettrico.

Lo sblocco del commutatore avviene eccitando il circuito.

ELETTROMAGNETI A TENSIONE:

24Vcc - 110Vcc - 220Vcc

altre tensioni su richiesta.

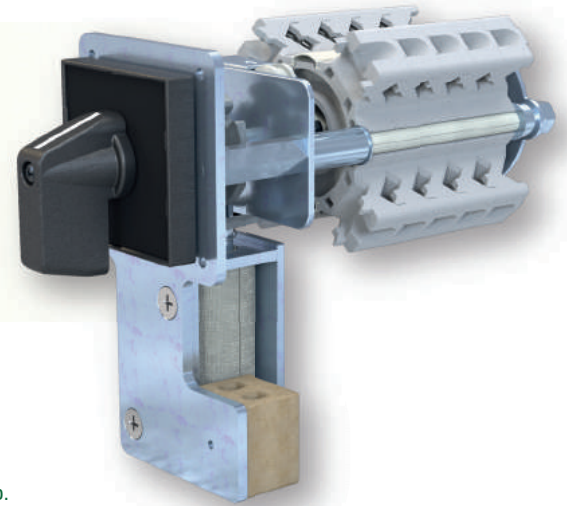

| N° of packets | 1 | 2 | 3 | 4 | 5 | 6 | 7 | 8 | 9 | 10 | 11 | 12 | 13 | 14 | 15 |
|---------------|----|----|----|-----|-----|-----|-----|-----|-----|-----|-----|-----|-----|-----|-----|
| Length (mm) | 69 | 81 | 93 | 105 | 117 | 129 | 141 | 153 | 165 | 177 | 189 | 201 | 213 | 225 | 237 |

Max 23 p.

Dimensions

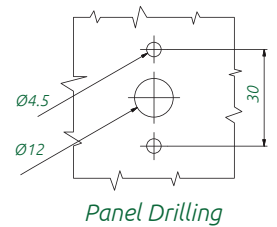
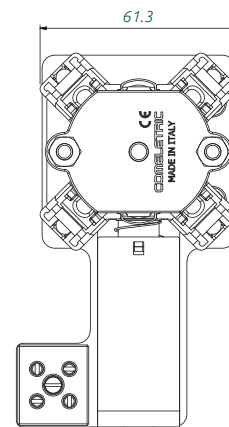
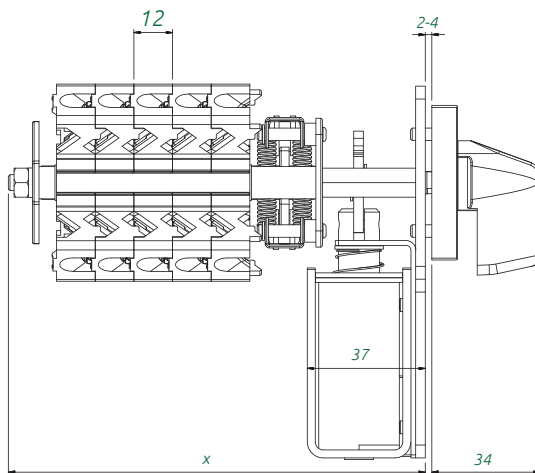
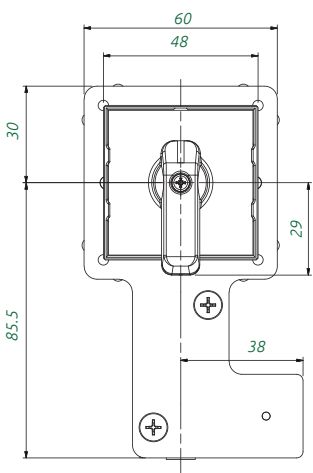

SR109 Frontplates SR109 Mostrine

COLOR CODE

| h | f | CODE |
|-------|--------|------|
| Black | Black | W001 |
| Black | White | W005 |
| Black | Yellow | W041 |
| Black | Red | W021 |
| Black | Black | W017 |

48 mm

COLOR CODE

| h | f | CODE |
|-------|--------|------|
| Black | Black | W009 |
| Black | White | W013 |
| Black | Yellow | W046 |
| Black | Red | W029 |
| Black | Black | W025 |

64 mm

COLOR CODE

| h | f | CODE |
|-------|--------|------|
| Black | Black | Y001 |
| Black | White | Y005 |
| Black | Yellow | -- |
| Black | Red | Y021 |
| Black | Black | Y017 |

48 mm

COLOR CODE

| h | f | CODE |
|-------|--------|------|
| Black | Black | P001 |
| Black | White | P005 |
| Black | Yellow | -- |
| Black | Red | P021 |
| Black | Black | P017 |

48 mm

COLOR CODE

| h | f | CODE |
|-------|--------|------|
| Black | Black | V009 |
| Black | White | V013 |
| Black | Yellow | -- |
| Black | Red | V029 |
| Black | Black | V025 |

64 mm

COLOR CODE

| h | f | CODE |
|-------|--------|------|
| Black | Black | N001 |
| Black | White | N005 |
| Black | Yellow | -- |
| Black | Red | N021 |
| Black | Black | N017 |

48 mm

COLOR CODE

| h | f | CODE |
|-------|--------|------|
| Black | Black | P009 |
| Black | White | P013 |
| Black | Yellow | -- |
| Black | Red | P029 |
| Black | Black | P025 |

64 mm

COLOR CODE

| h | f | CODE |
|-------|--------|------|
| Black | Black | Y009 |
| Black | White | Y013 |
| Black | Yellow | -- |
| Black | Red | Y029 |
| Black | Black | Y025 |

64 mm

COLOR CODE

| h | f | CODE |
|-------|--------|------|
| Black | Black | V001 |
| Black | White | V005 |
| Black | Yellow | -- |
| Black | Red | V021 |
| Black | Black | V017 |

48 mm

COLOR CODE

| h | f | CODE |
|-------|--------|------|
| Black | Black | |
| Black | White | |
| Black | Yellow | |
| Black | Red | |
| Black | Black | |

COLOR CODE

| h | f | CODE |
|-------|--------|------|
| Black | Black | |
| Black | White | |
| Black | Yellow | |
| Black | Red | |
| Black | Black | |

h=handle; f=frontplate
h=manopola; f=mostrina
Frontplate dimension on page 37/38
Dimensioni frontali a pag. 37/38

Metodo di ordinazione commutatori R20

In questo Catalogo si possono trovare alcuni schemi e le istruzioni per comporre autonomamente i codici d'ordinazione dei commutatori Serie R20 standard.

Per schemi Speciali o schemi non presenti in questo catalogo utilizzare il form. a pag. 34.

Gli schemi del presente catalogo ed il loro utilizzo nei codici sono applicabili esclusivamente alle serie di commutatori R20 e non per le altre Serie.

Codice prodotto

| | | | | | | |
|--------------------------------|------|--------|----|---|---|------|
| Esempio commutatore a manopola | R101 | 202002 | | | - | W001 |
| Esempio commutatore con chiave | R102 | 202002 | 07 | D | - | K001 |
| | ① | ② | ③ | ④ | | ⑤ |

① Modello del Commutatore.

Come n° di Modello si intende il montaggio e la forma costruttiva univoca di ogni commutatore
questo riferimento identifica la specifica costruzione meccanica del commutatore .

Questo n° di Modello viene indicato nel catalogo insieme al relativo disegno di ingombro e della foratura del pannello.

② Schema elettrico.

Questo numero rappresenta l'indicazione dello schema del commutatore richiesto.

Esso comprende lo schema elettrico ed il movimento della manopola , in riferimento agli schemi di seguito rappresentati.

③ Programma Bloccaggio/Estrazione chiave o altro.

Questo numero viene utilizzato solamente nei commutatori con chiave di comando , serratura di blocco, commutatore lucchettabile e commutatori con manopola estraibile.

Esso rappresenta la posizione in cui il commutatore può essere bloccato.

Il bloccaggio dei commutatori con chiave di comando o serratura di blocco avviene mediante l'estrazione della chiave dallo stesso.

Nei modelli con manopola estraibile la posizione il bloccaggio è la medesima di quelli a chiave , nei modelli lucchettabili il riferimento è invece la posizione dove viene data la possibilità di inserire il lucchetto.

La tabella di riferimento per il N° di programma di bloccaggio è presente a pag. 34 del presente catalogo e deve essere conforme allo spostamento della manopola previsto nello schema di riferimento del commutatore.

④ Chiave uguali tra di loro o chiavi differenti tra di loro.

Questo numero viene utilizzato solamente nei commutatori con chiave di comando , serratura di blocco.

Esso rappresenta se le chiavi dei commutatori devono essere uguali tra loro o Differenti tra loro.

La lettera "D" è l'indicazione di chiavi diverse tra di loro , quindi ogni commutatore ordinato avrà una chiave unica , quindi non è possibile manovrare altri commutatori con la medesima chiave.

Se non indicata i commutatori vengono forniti tutti con medesima chiave .

⑤ Tipo dimensione e colore Finitura (parte frontale)

Questo numero indica il tipo la dimensione ed il colore delle manopole e Finiture frontali del commutatore

Method for coding of R20 switches

In the present catalogue you will find examples of diagrams and the instruction enabling you to the creation by yourself of the ordering codes of R20 switches (standard).

For all the other special diagrams or any scheme which is not present in this catalogue, please use the form on page 34. The diagrams represented in this catalogue and their use in the codes are strictly related to R20 switches and not to all the others.

Switch code

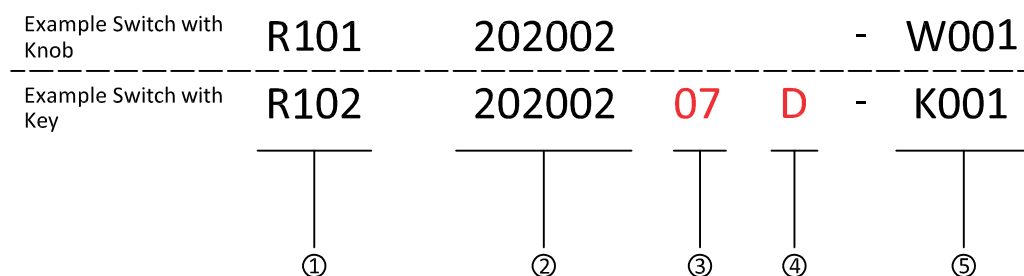

① Switch model

As switch model it is meant the kind of fitting and the mechanical structure of each specific switch
This reference is mentioned in the catalogue along with the dimensional drawing and the cutout of the panel.

② Electrical diagram

This reference is referred to the electrical diagram of the switch.
It includes the diagram and the movement of the knob, with reference to diagrams present in the following pages of the catalogue.

③ Locking/extraction program of keys or any other locking facility.

This reference is not used in those switches key operated, with ey lock, padlockable or with removable knob.
It gives the positions where the switch must be blocked.
The locking of any type of key switch is done by removing the key in the required position, the same for the switches with removable handle.
On the contrary, for switches with padlockable devices, this code reference will state where the padlockable could be inserted and blocking the rotation of the knob.
The table with locking references is on page 34 of this catalogue and it must be conform to the switching positions foreseen in the electrical diagram referred to the switch.

④ Alike or different key references.

This reference is present only in codes of switches with a key device.
It states if the switches must be equipped with keys with same references or all different ones.
Letter "D" at the end of the code means all different key references, so each switch will be provided with a unique key, the key of one switch could not be used for operating any other switch of the same supply.
If not clearly mentioned in the order, the switches will be provided keys all alike.

⑤ Dimension and front colour

This is referred to the dimension of the frontplate and its and knob's colour.

Switch Function and Configuration

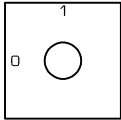
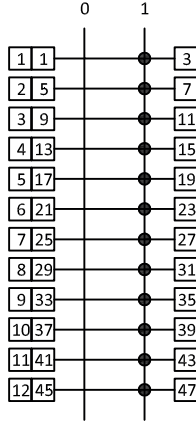
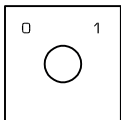
| Function | Handle Movements | Decks | Code | Connection Diagram |
|---|---|---|--|---|
| On/Off Switches | | | | |
| 1 pole 2 pole 3 pole 4 pole 5 pole 6 pole 7 pole 8 pole 9 pole 10 pole 11 pole 12 pole |  | 1 2 3 4 5 6 7 8 9 10 11 12 | 201019 202019 203019 204019 205019 206019 207019 208019 209019 210019 211019 212019 |  |
| 1 pole 2 pole 3 pole 4 pole 5 pole 6 pole 7 pole 8 pole 9 pole 10 pole 11 pole 12 pole |  | 1 2 3 4 5 6 7 8 9 10 11 12 | 201020 202020 203020 204020 205020 206020 207020 208020 209020 210020 211020 212020 | |

Double Throw Switch Without "0" position.

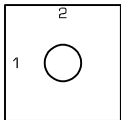
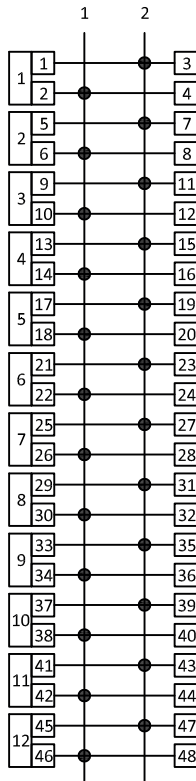
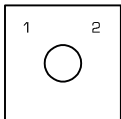
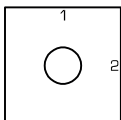
| | | | | |
|---|---|---|--|---|
| 1 pole 2 pole 3 pole 4 pole 5 pole 6 pole 7 pole 8 pole 9 pole 10 pole 11 pole 12 pole |  | 1 2 3 4 5 6 7 8 9 10 11 12 | 201001 202001 203001 204001 205001 206001 207001 208001 209001 210001 211001 212001 |  |
| 1 pole 2 pole 3 pole 4 pole 5 pole 6 pole 7 pole 8 pole 9 pole 10 pole 11 pole 12 pole |  | 1 2 3 4 5 6 7 8 9 10 11 12 | 201002 202002 203002 204002 205002 206002 207002 208002 209002 210002 211002 212002 | |
| 1 pole 2 pole 3 pole 4 pole 5 pole 6 pole 7 pole 8 pole 9 pole 10 pole 11 pole 12 pole |  | 1 2 3 4 5 6 7 8 9 10 11 12 | 201003 202003 203003 204003 205003 206003 207003 208003 209003 210003 211003 212003 | |

Switch Function and Configuration

| Function | Handle Movements | Decks | Code | Connection Diagram |
|----------|------------------|-------|------|--------------------|
|----------|------------------|-------|------|--------------------|

2 Positions switch with 1 input & 2 Output in each deck

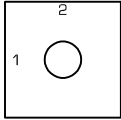
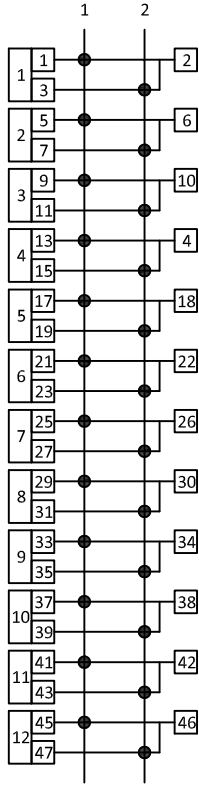
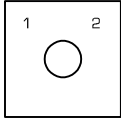
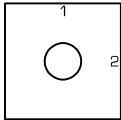
| | | | | |
|---|---|---|--|--|
| 1 pole 2 pole 3 pole 4 pole 5 pole 6 pole 7 pole 8 pole 9 pole 10 pole 11 pole 12 pole |  | 1 2 3 4 5 6 7 8 9 10 11 12 | 201007 202007 203007 204007 205007 206007 207007 208007 209007 210007 211007 212007 |  |
| 1 pole 2 pole 3 pole 4 pole 5 pole 6 pole 7 pole 8 pole 9 pole 10 pole 11 pole 12 pole |  | 1 2 3 4 5 6 7 8 9 10 11 12 | 201008 202008 203008 204008 205008 206008 207008 208008 209008 210008 211008 212008 | |
| 1 pole 2 pole 3 pole 4 pole 5 pole 6 pole 7 pole 8 pole 9 pole 10 pole 11 pole 12 pole |  | 1 2 3 4 5 6 7 8 9 10 11 12 | 201009 202009 203009 204009 205009 206009 207009 208009 209009 210009 211009 212009 | |

2 Positions switch with Make before Break Contacts

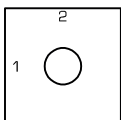
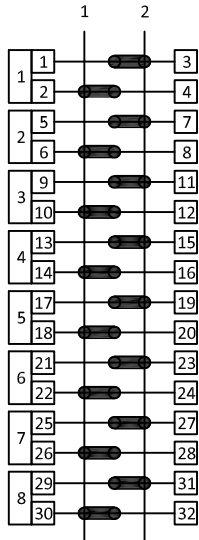
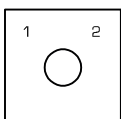
| | | | | |
|--|---|--------------------------------------|--|---|
| 1 pole 2 pole 3 pole 4 pole 5 pole 6 pole 7 pole 8 pole |  | 1 2 3 4 5 6 7 8 | 201055 202055 203055 204055 205055 206055 207055 208055 |  |
| 1 pole 2 pole 3 pole 4 pole 5 pole 6 pole 7 pole 8 pole |  | 1 2 3 4 5 6 7 8 | 201056 202056 203056 204056 205056 206056 207056 208056 | |

Switch Function and Configuration

| Function | Handle Movements | Decks | Code | Connection Diagram |
|----------|------------------|-------|------|--------------------|
|----------|------------------|-------|------|--------------------|

3 pos. switch with "0" Position with electrically isolated contacts

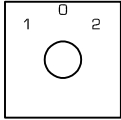
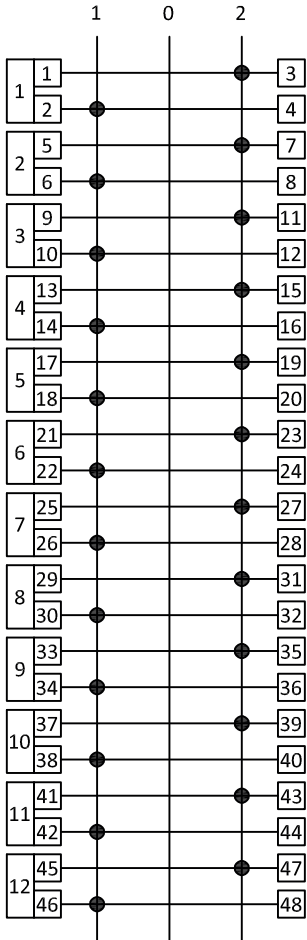
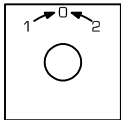
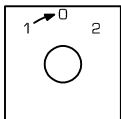
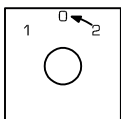
| | | | | |
|--|---|---|--|--|
| 1 pole 2 pole 3 pole 4 pole 5 pole 6 pole 7 pole 8 pole 9 pole 10 pole 11 pole 12 pole |  | 1 2 3 4 5 6 7 8 9 10 11 12 | 301001 302001 303001 304001 305001 306001 307001 308001 309001 310001 311001 312001 |  |
| With Spring return to "0" position from pos."1" & pos."2". 1 pole 2 pole 3 pole 4 pole 5 pole 6 pole 7 pole 8 pole |  | 1 2 3 4 5 6 7 8 | M301001 M302001 M303001 M304001 M305001 M306001 M307001 M308001 | |
| With Spring return to "0" position from pos."1". 1 pole 2 pole 3 pole 4 pole 5 pole 6 pole 7 pole 8 pole |  | 1 2 3 4 5 6 7 8 | 301012 302012 303012 304012 305012 306012 307012 308012 | |
| With Spring return to "0" position from pos."2". 1 pole 2 pole 3 pole 4 pole 5 pole 6 pole 7 pole 8 pole |  | 1 2 3 4 5 6 7 8 | 301020 302020 303020 304020 305020 306020 307020 308020 | |

Switch Function and Configuration

| Function | Handle Movements | Decks | Code | Connection Diagram |
|----------|------------------|-------|------|--------------------|
|----------|------------------|-------|------|--------------------|

3 pos. switch with "0" Position with 1 input and 2 output in each deck.

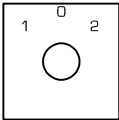
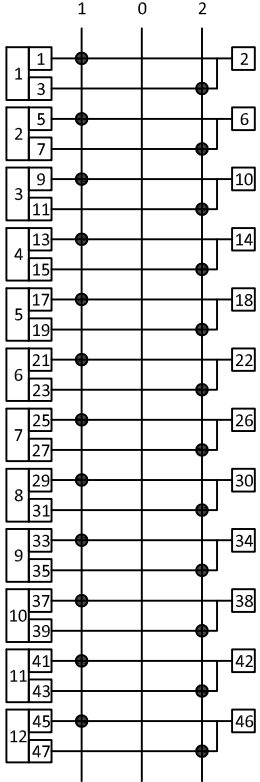
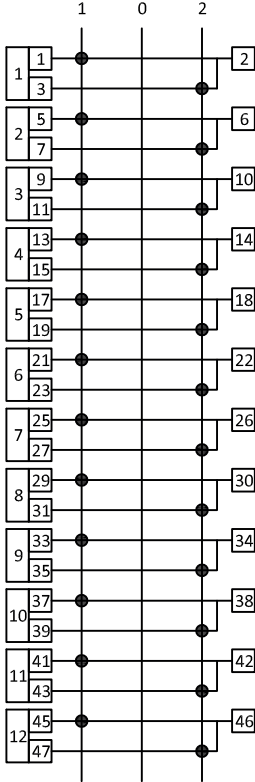
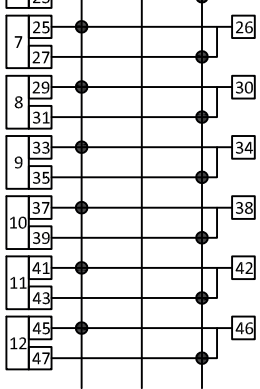
| | | | | |
|--|--|---|--|--|
| 1 pole 2 pole 3 pole 4 pole 5 pole 6 pole 7 pole 8 pole 9 pole 10 pole 11 pole 12 pole |  | 1 2 3 4 5 6 7 8 9 10 11 12 | 301003 302003 303003 304003 305003 306003 307003 308003 309003 310003 311003 312003 |  |
| With Spring return to "0" position from pos."1" & pos."2". 1 pole 2 pole 3 pole 4 pole 5 pole 6 pole 7 pole 8 pole |  | 1 2 3 4 5 6 7 8 | M301003 M302003 M303003 M304003 M305003 M306003 M307003 M308003 |  |

3 pos. switch without "0" Position with 1 input and 3 output in each deck.

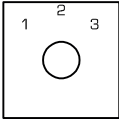
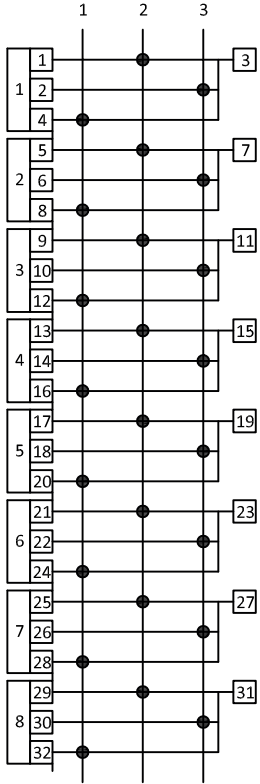
| | | | | |
|---|---|---|--|---|
| 1 pole 2 pole 3 pole 4 pole 5 pole 6 pole 7 pole 8 pole 9 pole 10 pole 11 pole 12 pole |  | 1 2 3 4 5 6 7 8 9 10 11 12 | 301004 302004 303004 304004 305004 306004 307004 308004 309004 310004 311004 312004 |  |
|---|---|---|--|---|

Switch Function and Configuration

| Function | Handle Movements | Decks | Code | Connection Diagram |
|----------|------------------|-------|------|--------------------|
|----------|------------------|-------|------|--------------------|

3 pos. switch Without "0" Position, with electrically isolated contacts.

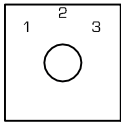
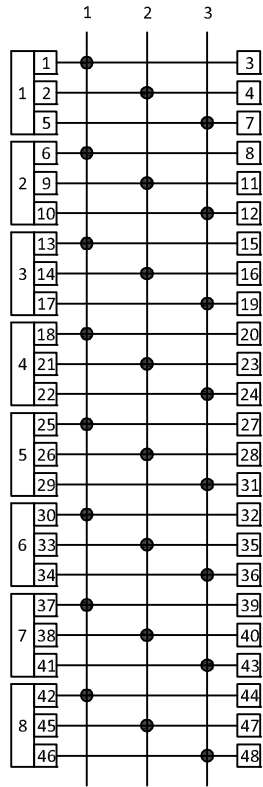
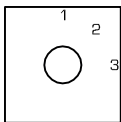
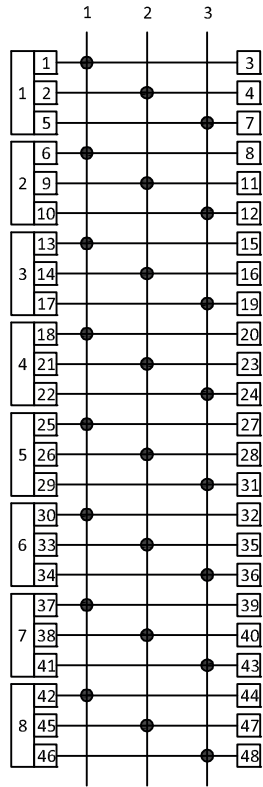
| | | | | |
|--|---|--|--|--|
| 1 pole 2 pole 3 pole 4 pole 5 pole 6 pole 7 pole 8 pole |  | 2 3 5 6 8 9 11 12 | 302078 303078 305078 306078 308078 309078 311078 312078 |  |
| 1 pole 2 pole 3 pole 4 pole 5 pole 6 pole 7 pole 8 pole |  | 2 3 5 6 8 9 11 12 | 302134 303134 305134 306134 308134 309134 311134 312134 |  |

3 pos. switch with "0" Position, with electrically isolated contacts.

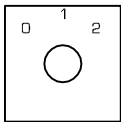
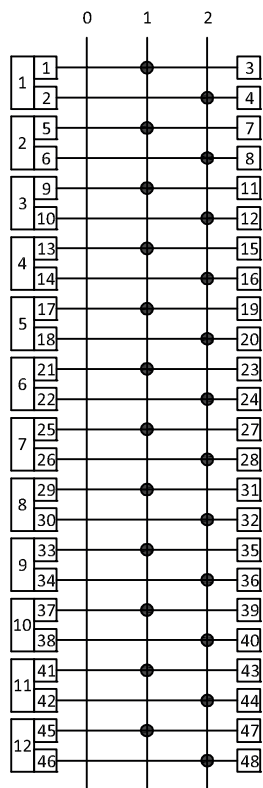
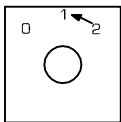
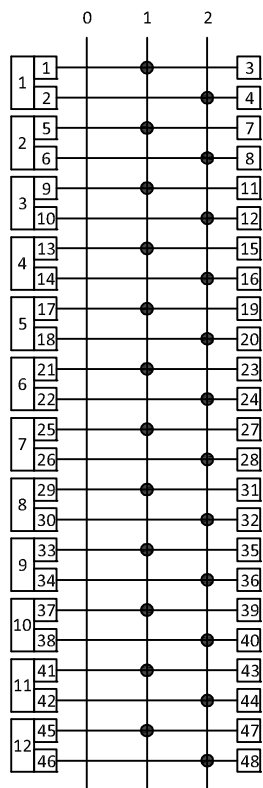
| | | | | |
|---|---|---|--|---|
| 1 pole 2 pole 3 pole 4 pole 5 pole 6 pole 7 pole 8 pole 9 pole 10 pole 11 pole 12 pole |  | 1 2 3 4 5 6 7 8 9 10 11 12 | 301016 302016 303016 304016 305016 306016 307016 308016 309016 310016 311016 312016 |  |
| With Spring return to "0" position from pos. "2". 1 pole 2 pole 3 pole 4 pole 5 pole 6 pole 7 pole 8 pole |  | 1 2 3 4 5 6 7 8 | 301048 302048 303048 304048 305048 306048 307048 308048 |  |

Switch Function and Configuration

| Function | Handle Movements | Decks | Code | Connection Diagram |
|----------|------------------|-------|------|--------------------|
|----------|------------------|-------|------|--------------------|

4 pos. switch With "0" Position, with electrically isolated contacts.

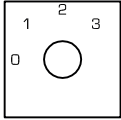
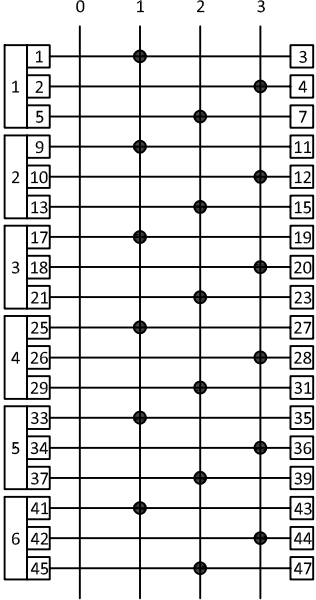
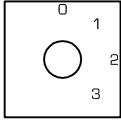
| | | | | |
|--|---|------------------------------|--|--|
| 1 pole 2 pole 3 pole 4 pole 5 pole 6 pole |  | 2 4 6 8 10 12 | 402008 404008 406008 408008 410008 412008 |  |
| 1 pole 2 pole 3 pole 4 pole 5 pole 6 pole |  | 2 4 6 8 10 12 | 402087 404087 406087 408087 410087 412087 | |

4 pos. switch with "0" Position, with 1 Input and 3 output per Pole.

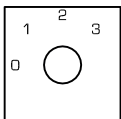
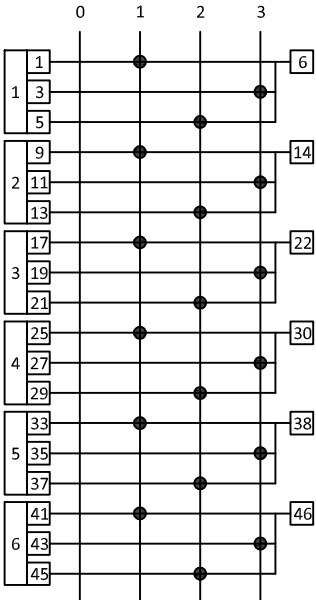
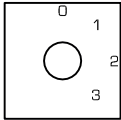
| | | | | |
|--|---|------------------------------|--|---|
| 1 pole 2 pole 3 pole 4 pole 5 pole 6 pole |  | 2 4 6 8 10 12 | 402011 404011 406011 408011 410011 412011 |  |
| 1 pole 2 pole 3 pole 4 pole 5 pole 6 pole |  | 2 4 6 8 10 12 | 402088 404088 406088 408088 410088 412088 | |

Switch Function and Configuration

| Function | Handle Movements | Decks | Code | Connection Diagram |
|----------|------------------|-------|------|--------------------|
|----------|------------------|-------|------|--------------------|

4 pos. switch Without "0" Position, with electrically isolated contacts.

| | | | | |
|--|--|------------------------------|--|--|
| 1 pole 2 pole 3 pole 4 pole 5 pole 6 pole | | 2 4 6 8 10 12 | 402003 404003 406003 408003 410003 412003 | |
| 1 pole 2 pole 3 pole 4 pole 5 pole 6 pole | | 2 4 6 8 10 12 | 402017 404017 406017 408017 410017 412017 | |

4 pos. switch without "0" Position, with 1 Input and 4 output per Pole.

| | | | | |
|--|--|------------------------------|--|--|
| 1 pole 2 pole 3 pole 4 pole 5 pole 6 pole | | 2 4 6 8 10 12 | 402007 404007 406007 408007 410007 412007 | |
| 1 pole 2 pole 3 pole 4 pole 5 pole 6 pole | | 2 4 6 8 10 12 | 402089 404089 406089 408089 410089 412089 | |

Switch Function and Configuration

| Function | Handle Movements | Decks | Code | Connection Diagram |
|----------|------------------|-------|------|--------------------|
|----------|------------------|-------|------|--------------------|

5 pos. switch With "0" Position, with electrically isolated contacts.

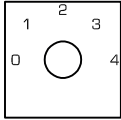
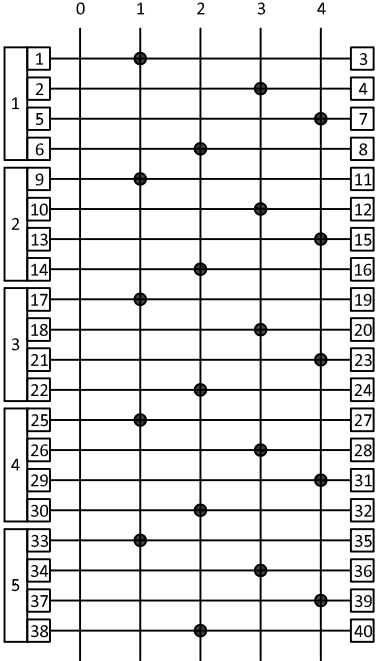
| | | | | |
|--|---|------------------------|--|---|
| 1 pole 2 pole 3 pole 4 pole 5 pole |  | 2 4 6 8 10 | 502020 504020 506020 508020 510020 |  |
|--|---|------------------------|--|---|

5 pos. switch with "0" Position, with 1 Input and 4 output per Pole.

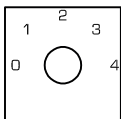
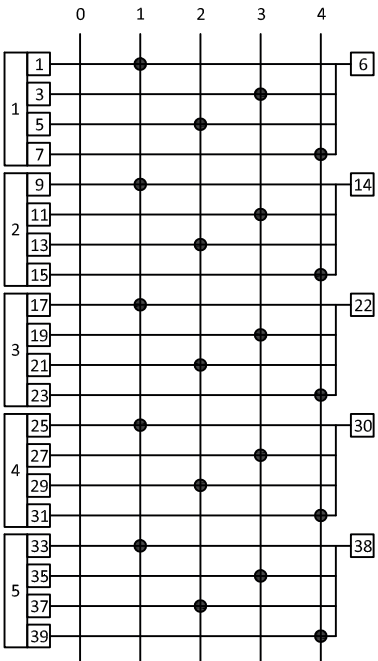
| | | | | |
|--|---|------------------------|--|--|
| 1 pole 2 pole 3 pole 4 pole 5 pole |  | 2 4 6 8 10 | 502010 504010 506010 508010 510010 |  |
|--|---|------------------------|--|--|

Switch Function and Configuration

| Function | Handle Movements | Decks | Code | Connection Diagram |
|----------|------------------|-------|------|--------------------|
|----------|------------------|-------|------|--------------------|

5 pos. switch Without "0" Position, with electrically isolated contacts.

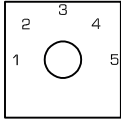
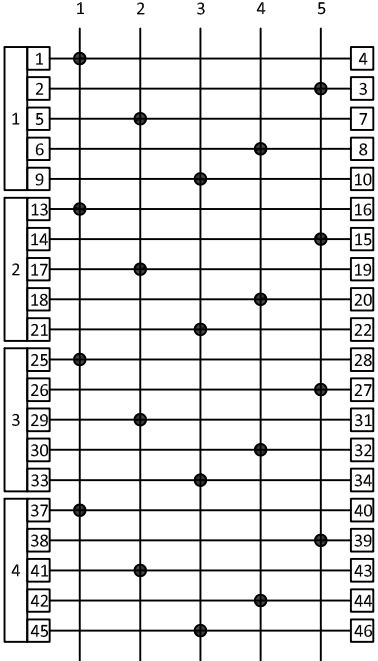
| | | | | |
|--------------------------------------|---|-------------------|--------------------------------------|---|
| 1 pole 2 pole 3 pole 4 pole |  | 3 6 9 12 | 503018 506018 509018 512018 |  |
|--------------------------------------|---|-------------------|--------------------------------------|---|

5 pos. switch without "0" Position, with 1 Input and 5 output per Pole.

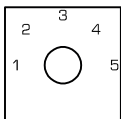
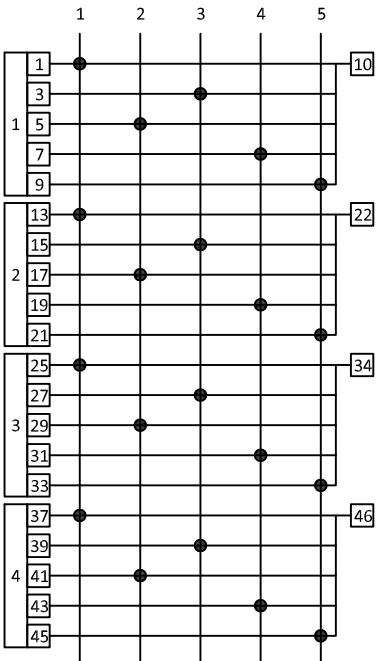
| | | | | |
|--------------------------------------|---|-------------------|--------------------------------------|--|
| 1 pole 2 pole 3 pole 4 pole |  | 3 6 9 12 | 503013 506013 509013 512013 |  |
|--------------------------------------|---|-------------------|--------------------------------------|--|

Switch Function and Configuration

| Function | Handle Movements | Decks | Code | Connection Diagram |
|----------|------------------|-------|------|--------------------|
|----------|------------------|-------|------|--------------------|

6 pos. switch With "0" Position, with electrically isolated contacts.

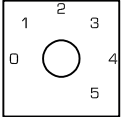
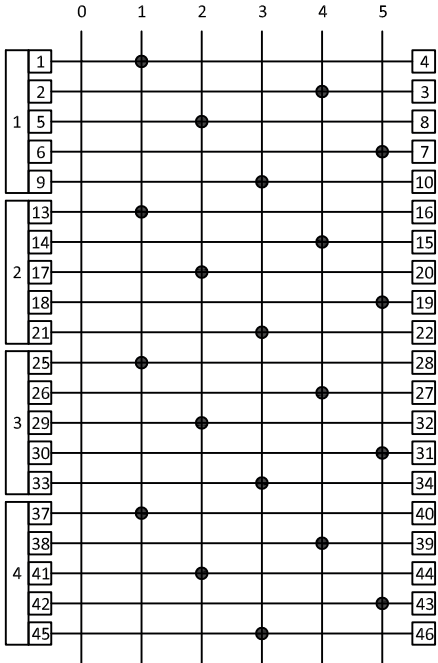
| | | | | |
|--------------------------------------|---|-------------------|--------------------------------------|---|
| 1 pole 2 pole 3 pole 4 pole |  | 3 6 9 12 | 603009 606009 609009 612009 |  |
|--------------------------------------|---|-------------------|--------------------------------------|---|

6 pos. switch with "0" Position, with 1 Input and 5 output per Pole.

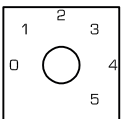
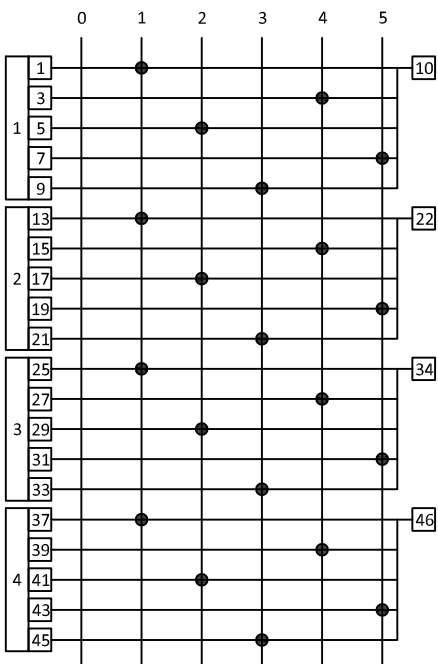
| | | | | |
|--------------------------------------|---|-------------------|--------------------------------------|--|
| 1 pole 2 pole 3 pole 4 pole |  | 3 6 9 12 | 603003 606003 609003 612003 |  |
|--------------------------------------|---|-------------------|--------------------------------------|--|

Switch Function and Configuration

| Function | Handle Movements | Decks | Code | Connection Diagram |
|----------|------------------|-------|------|--------------------|
|----------|------------------|-------|------|--------------------|

6 pos. switch Without "0" Position, with electrically isolated contacts.

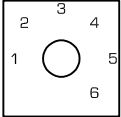
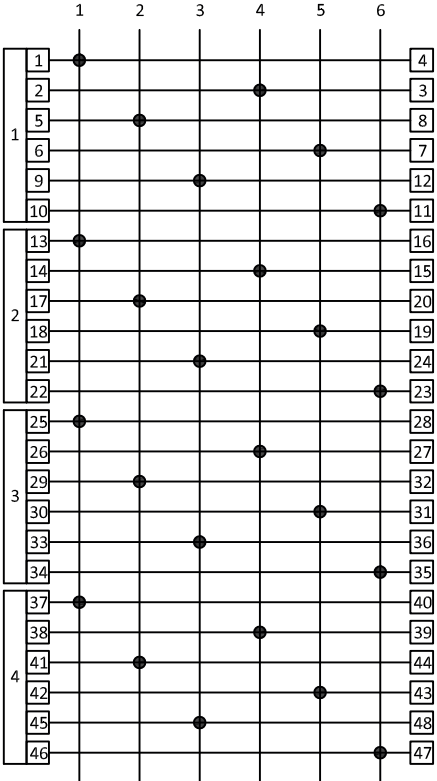
| | | | | |
|--|---|-----------------------------|--|---|
| <p>1 pole 2 pole 3 pole 4 pole</p> |  | <p>3 6 9 12</p> | <p>603008 606008 609008 612008</p> |  |
|--|---|-----------------------------|--|---|

6 pos. switch without "0" Position, with 1 Input and 6 output per Pole.

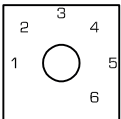
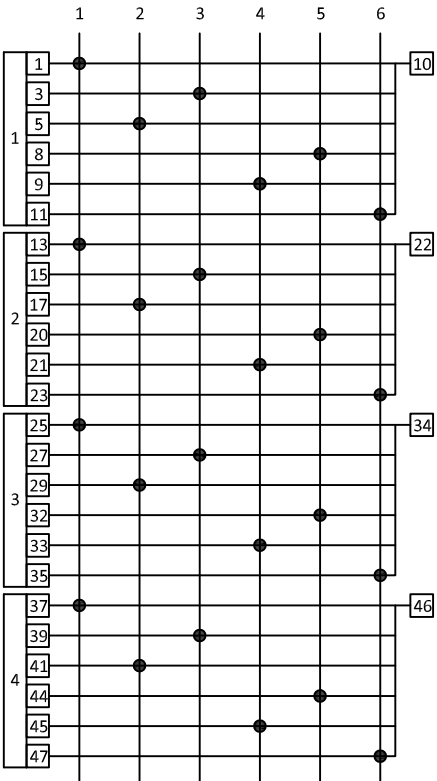
| | | | | |
|--|---|-----------------------------|--|--|
| <p>1 pole 2 pole 3 pole 4 pole</p> |  | <p>3 6 9 12</p> | <p>603004 606004 609004 612004</p> |  |
|--|---|-----------------------------|--|--|

Switch Function and Configuration

| Function | Handle Movements | Decks | Code | Connection Diagram |
|----------|------------------|-------|------|--------------------|
|----------|------------------|-------|------|--------------------|

7 pos. switch With "0" Position, with electrically isolated contacts.

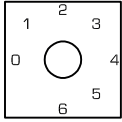
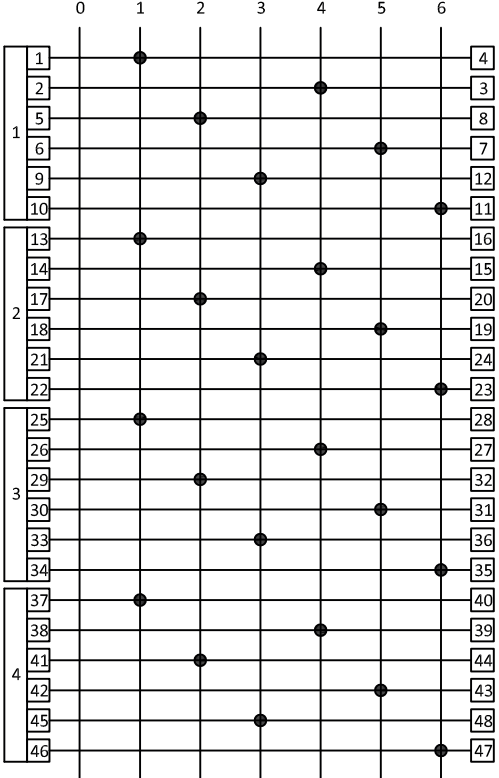
| | | | | |
|--------------------------------------|---|-------------------|--------------------------------------|---|
| 1 pole 2 pole 3 pole 4 pole |  | 3 6 9 12 | 703012 706012 709012 712012 |  |
|--------------------------------------|---|-------------------|--------------------------------------|---|

7 pos. switch with "0" Position, with 1 Input and 6 output per Pole.

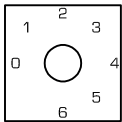
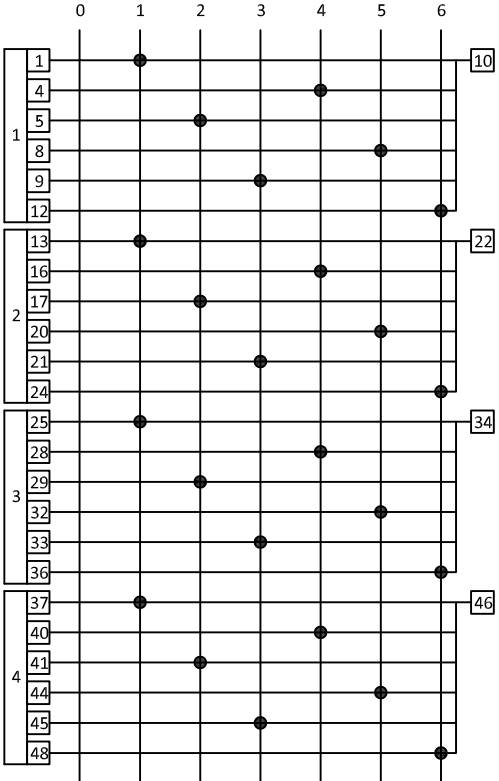
| | | | | |
|--------------------------------------|---|-------------------|--------------------------------------|--|
| 1 pole 2 pole 3 pole 4 pole |  | 3 6 9 12 | 703006 706006 709006 712006 |  |
|--------------------------------------|---|-------------------|--------------------------------------|--|

Switch Function and Configuration

| Function | Handle Movements | Decks | Code | Connection Diagram |
|----------|------------------|-------|------|--------------------|
|----------|------------------|-------|------|--------------------|

7 pos. switch Without "0" Position, with electrically isolated contacts.

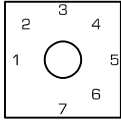
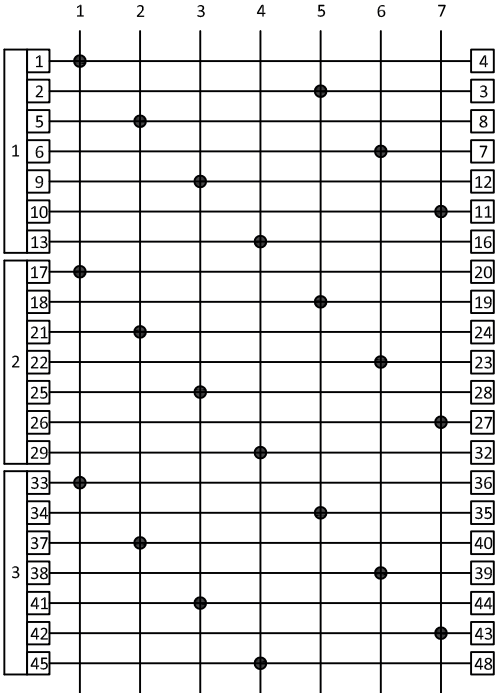
| | | | | |
|----------------------------|---|--------------|----------------------------|---|
| 1 pole 2 pole 3 pole |  | 4 8 12 | 704001 708001 712001 |  |
|----------------------------|---|--------------|----------------------------|---|

7 pos. switch Without "0" Position, with 1 Input and 7 output per Pole.

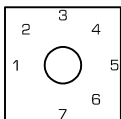
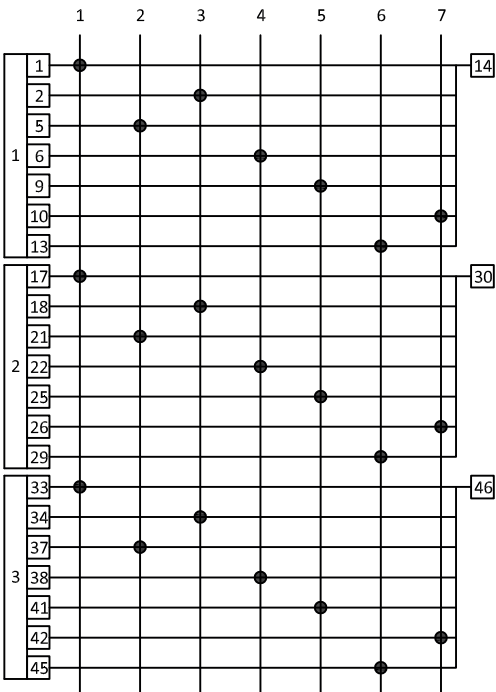
| | | | | |
|----------------------------|---|--------------|----------------------------|--|
| 1 pole 2 pole 3 pole |  | 4 8 12 | 704013 708013 712013 |  |
|----------------------------|---|--------------|----------------------------|--|

Switch Function and Configuration

| Function | Handle Movements | Decks | Code | Connection Diagram |
|----------|------------------|-------|------|--------------------|
|----------|------------------|-------|------|--------------------|

8 pos. switch With "0" Position, with electrically isolated contacts.

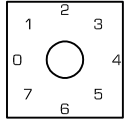
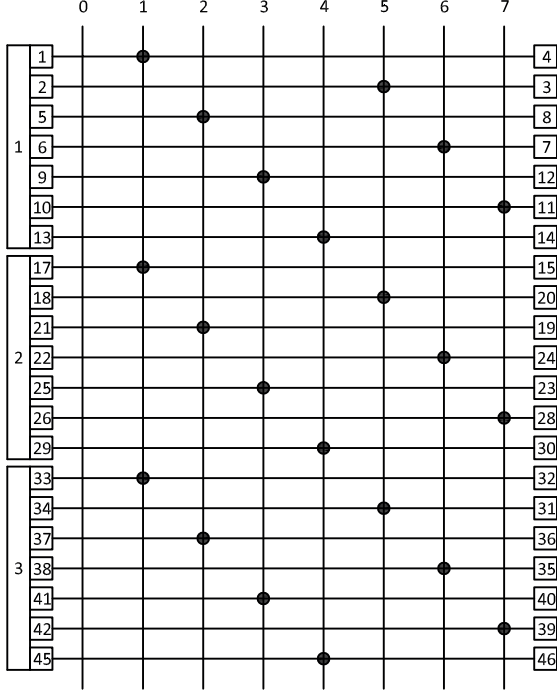
| | | | | |
|----------------------------|---|--------------|----------------------------|---|
| 1 pole 2 pole 3 pole |  | 4 8 12 | 804003 808003 812003 |  |
|----------------------------|---|--------------|----------------------------|---|

8 pos. switch with "0" Position, with 1 Input and 7 output per Pole.

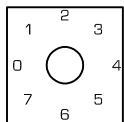
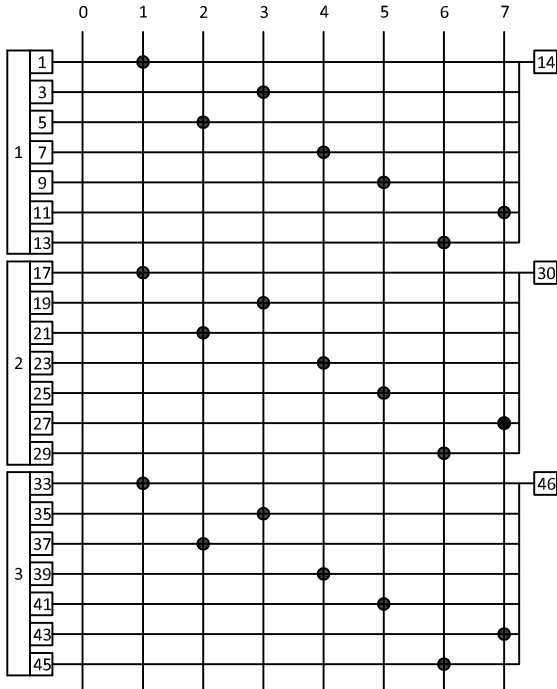
| | | | | |
|----------------------------|---|--------------|----------------------------|--|
| 1 pole 2 pole 3 pole |  | 4 8 12 | 804005 808005 812005 |  |
|----------------------------|---|--------------|----------------------------|--|

Switch Function and Configuration

| Function | Handle Movements | Decks | Code | Connection Diagram |
|----------|------------------|-------|------|--------------------|
|----------|------------------|-------|------|--------------------|

8 pos. switch Without "0" Position, with electrically isolated contacts.

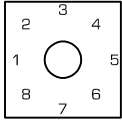
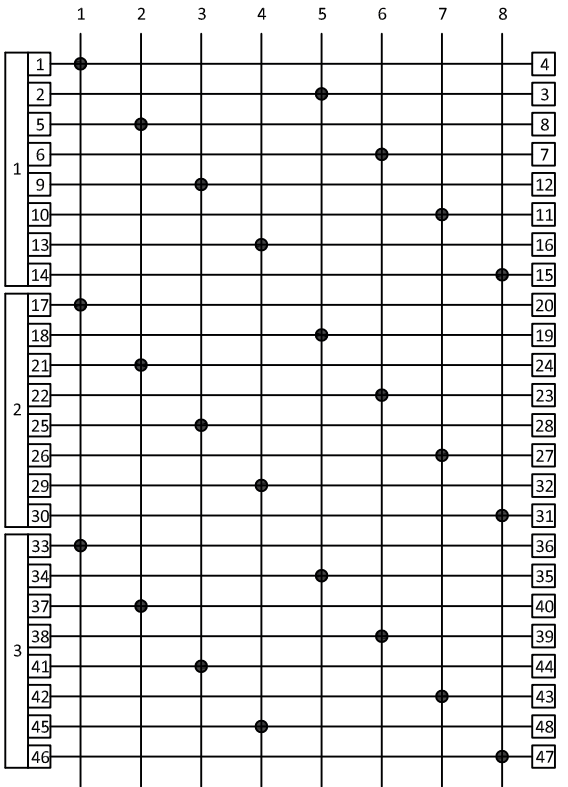
| | | | | |
|-------------------------------------|---|-----------------------|-------------------------------------|---|
| <p>1 pole 2 pole 3 pole</p> |  | <p>4 8 12</p> | <p>804001 808001 812001</p> |  |
|-------------------------------------|---|-----------------------|-------------------------------------|---|

8 pos. switch without "0" Position, with 1 Input and 8 output per Pole.

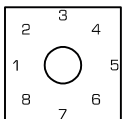
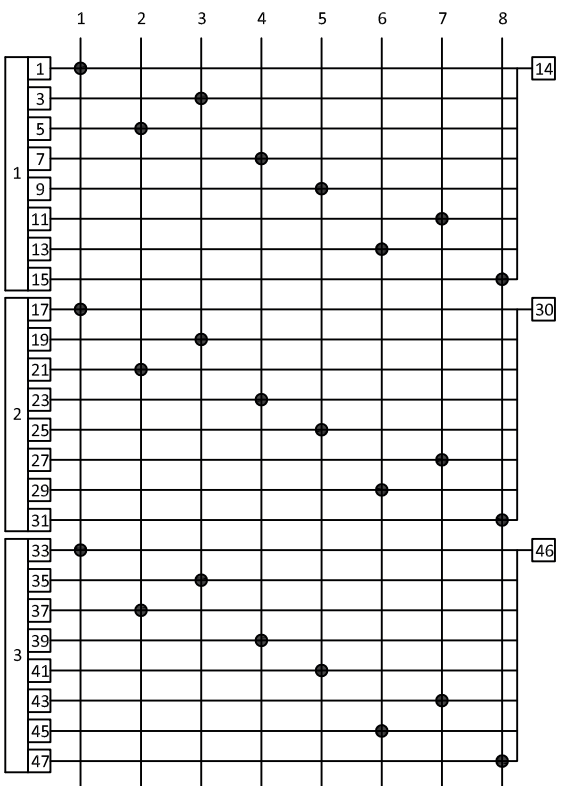
| | | | | |
|-------------------------------------|---|-----------------------|-------------------------------------|--|
| <p>1 pole 2 pole 3 pole</p> |  | <p>4 8 12</p> | <p>804002 808002 812002</p> |  |
|-------------------------------------|---|-----------------------|-------------------------------------|--|

Switch Function and Configuration

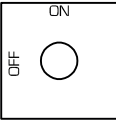
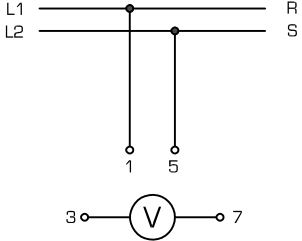
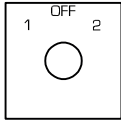
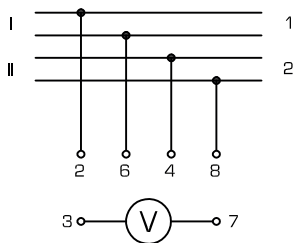
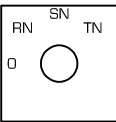
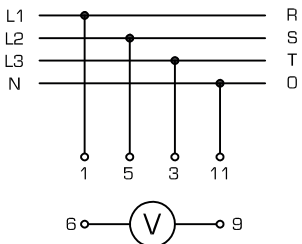
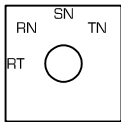
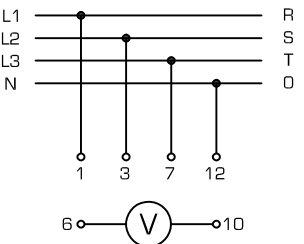
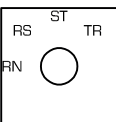
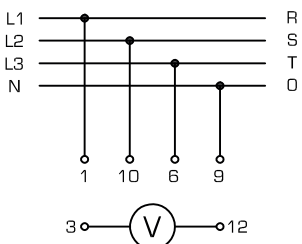
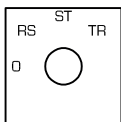
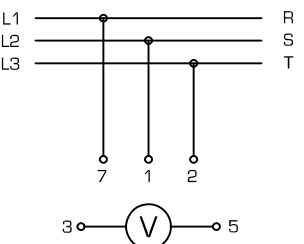
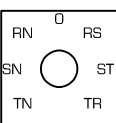
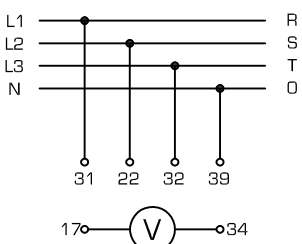
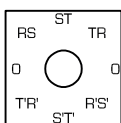
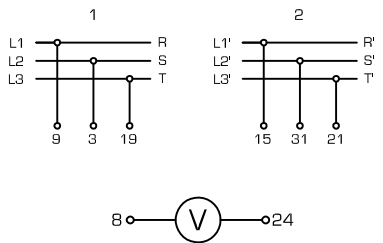
| | | | |
|---|---|---|---|
| <p>Diagram n° 202V</p> | <p>VOLTMETER SWITCH: 2 wire Single Phase or DC</p> | <p>Diagram n° 302V10</p> | <p>VOLTMETER SWITCH: 4 wire two Phases or two separate DC circuits</p> |
|  |  |  |  |
| <p>Diagram n° 403V15</p> | <p>VOLTMETER SWITCH: 3 Phase Voltage</p> | <p>Diagram n° 403V16</p> | <p>VOLTMETER SWITCH: 1 Phase to Phase and 3 phases Voltage.</p> |
|  |  |  |  |
| <p>Diagram n° 403V17</p> | <p>VOLTMETER SWITCH: 1 Phase Voltage and 3 Phase to Phase</p> | <p>Diagram n° 402V09</p> | <p>VOLTMETER SWITCH: 3 Phase to Phase</p> |
|  |  |  |  |
| <p>Diagram n° 705V12</p> | <p>VOLTMETER SWITCH: 3 Phase and 3 Phase to Phase</p> | <p>Diagram n° 8S08</p> | <p>VOLTMETER SWITCH: 3 Phase to Phase in two 3 Phase circuits.</p> |
|  |  |  |  |

Switch Function and Configuration

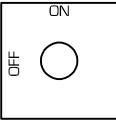
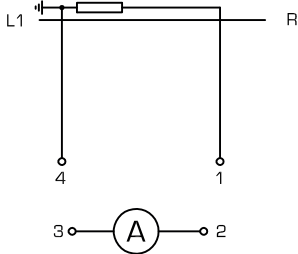
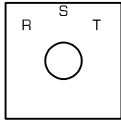
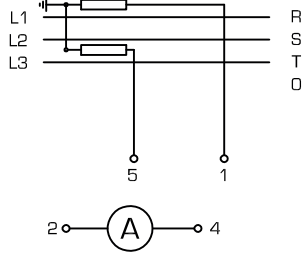
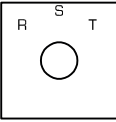
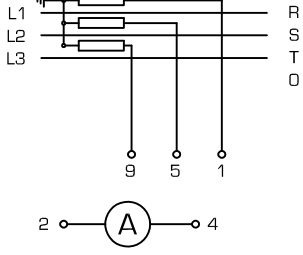
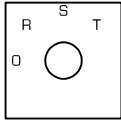
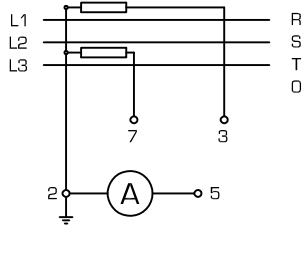
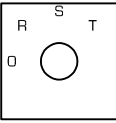
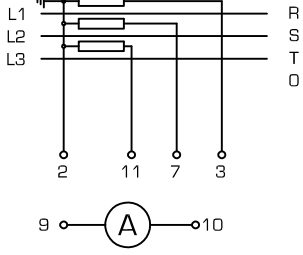
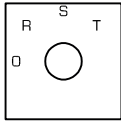
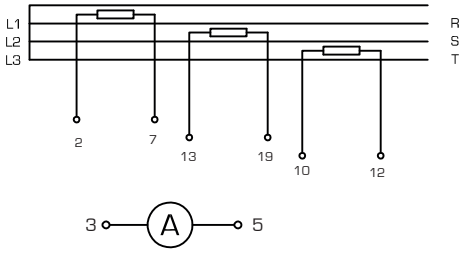
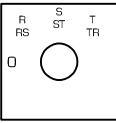
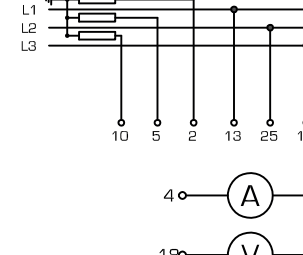
| | | | |
|---|--|---|---|
| <p>Diagram n° 2G02</p> | <p>AMMETER SWITCH: 1 phase Current Transformer with "0" Pos.</p> | <p>Diagram n° 302A01</p> | <p>AMMETER SWITCH: 3 Current Measurements with 2 CT without "0"</p> |
|  |  |  |  |
| <p>Diagram n° 303A11</p> | <p>AMMETER SWITCH: 3 Current Measurements with 3 CT without "0"</p> | <p>Diagram n° 402A06</p> | <p>AMMETER SWITCH: 3 Current Measurements with 2 CT with "0"</p> |
|  |  |  |  |
| <p>Diagram n° 403A08</p> | <p>AMMETER SWITCH: 3 Current Measurements with 3 CT with "0"</p> | <p>Diagram n° 405A02</p> | <p>AMMETER SWITCH: 3 Current Measurements with 3 CT with "0" crossing Currents.</p> |
|  |  |  |  |
| <p>Diagram n° 407AV01</p> | <p>VOLT-AMMETER SWITCH: 3 Current Measurements with 3 CT with "0" For Voltages and Currents Measurements</p> | | |
|  |  | | |

Standard Escutcheon Plate Ordering

La mostrina si intende parte integrante del commutatore in quanto necessaria per il fissaggio al pannello dello stosso, se non specificata nessuna incisione essa verrà fornita Neutra, codice 00000.

The Escutcheon plate is strictly necessary for fitting the switch to the panel , if none engraving is specified , the frontplate will be supplied Blank , code 00000. The engraving listed below, are only a little part of those available, requir the code of the needed one if not present.

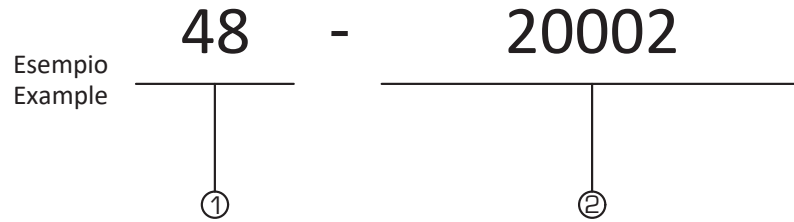

① Dimensions of the Escutcheon Plate.

48= 48x48mm
64= 64x64mm

②

2 Positions

| | | | | | | | | | | | | | |
|-------------------------|--------------|----------------|----------------|------------|---------------|---------------|----------------|-------------------|------------|---------------------|------------------|------------|-------------------|
| 1 O | AUT. MAN | MAN. AUT. | AUT. MAN. | 1 2 | INCL. ESQ. | DIST. LOC. | 2 1 | REMOTE LOCAL | 1 E | L R | LOC. REM. | TE TI | OFF ON |
| 20002 | 20004 | 20006 | 20007 | 20008 | 20010 | 20012 | 20013 | 20016 | 20022 | 20028 | 20030 | 20035 | 20036 |
| R L | REM. LOC. | ON OFF | AUTO O | MAN. O | LOC. DIST. | OFF ON | AUT. MAN. | PROVA SERVIZIO | LOC. SUPV. | EMERGENCY NORMAL | A B | SHIP SHORE | HAND AUTO |
| 20037 | 20041 | 20050 | 20054 | 20055 | 20059 | 20068 | 20070 | 20106 | 20187 | 20160 | 20065 | 20085 | 20184 |
| PARALLELO INDIVIDUAL | REM. SUPV. | MANUAL AUTO | IN OUT | TRIP ALARM | MANUAL AUTO | SERV. TRIP | NORMAL TEST | TR1 TR2 | ATA ATB | MAN A B INVA | WINTER SUMMER | LOC. SCADA | OUTBOARD SPARE |
| 20116 | 20404 | 20231 | 20322 | 20505 | 20463 | 20058 | 20138 | 20174 | 20196 | 20277 | 20289 | 20429 | 20341 |
| NORMAL TRANSFER | REM. SUPV. | GS | BYPASS SERVICE | M | O | OUT IN | TRIP NORMAL | DG1 DG2 | HAND AUTO | AUTO MANUAL | | | |
| 20346 | 20404 | 20161 | 20510 | 20021 | 20001 | 20464 | 20553 | 20279 | 20152 | 20205 | | | |

3 Positions

| | | | | | | | | | | | | | |
|----------------|------------------|----------------|---------------|-----------------|-------------|-----------------|----------------|---------------|----------------------|---------------|-----------------|-------------|----------------|
| MAN. AUT. | AUT. MAN. | M A | CH. AP. | DIM. ALUM. | AP. CH. | 1 2 | TEST TRIP | 1 2 | LOC. DIST. | 1 2 3 | ALUM. DIM. | OPEN CLOSE | CLOSE OPEN |
| 30003 | 30004 | 30005 | 30010 | 30011 | 30012 | 30013 | 30014 | 30015 | 30016 | 30017 | 30019 | 30024 | 30031 |
| A C B | START STOP | TRIP CLOSE | LOC. REM. | LOC. AUT. | 2 1 3 | O MAN. AUT. | O MAN. AUT. | O 1 2 | C-BREAKER TRIP CLOSE | TEST STOP | EM. LOC. REM. | ON OFF TEST | RAISE LOWER |
| 30032 | 30050 | 30052 | 30057 | 30060 | 30082 | 30083 | 30084 | 30385 | 30085 | 30086 | 30078 | 30079 | 30087 |
| DOS SCADA SCS | INCR. DECR. | COLD HEAT | G1 G2 | A X/B B | OFF ON | L R | O 1+3 | NEUTRAL CLOSE | 1 OFF 2 | RS ST TR | RY YB BR | R S T | R Y B |
| 30088 | 30089 | 30090 | 30040 | 30047 | 30055 | 30062 | 30172 | 30120 | 30561 | 30630 | 30631 | 30632 | 30633 |
| TEST LOC. REM. | A B C | TEST TRIP N.O. | AUTO OFF MAN. | LOWER OFF RAISE | OUVRE FERME | LOC. REM. SUPV. | SHORE OFF GEN. | IN OUT | AUTO HAND | LOC. OFF REM. | TR1 PARALL. TR2 | T1 T1+T2 T2 | MAN. LOC. REM. |
| 30025 | 30114 | 30371 | 30080 | 30113 | 30154 | 30165 | 30634 | 30626 | 30635 | 30467 | 30476 | 30486 | 30192 |
| IN NORMAL OUT | BYPASS OFF CHECK | O L1 L2 | S P M | AUTO MAN. | | | | | | | | | |
| 30609 | 30608 | 30183 | 30526 | 30108 | | | | | | | | | |

4 Positions

| | | | | | | | | | | | | | |
|-----------|-----------|-----------|-----------|-----------|-----------|-----------|-----------|-----------|-----------|-----------|-----------|-----------|-----------|
| 40001 | 40002 | 40003 | 40004 | 40005 | 40006 | 40007 | 40008 | 40009 | 40010 | 40011 | 40012 | 40013 | 40014 |
| 40112 | 40027 | 40017 | 40015 | 40018 | 40019 | 40021 | 40022 | 30015 | 40177 | 40023 | 40072 | 40029 | 40071 |
| 40235 | 40019 | 40230 | 40237 | 40037 | 40056 | 40137 | 40223 | 40231 | | | | | |

5 Positions

| | | | | | | | | | | | | |
|-----------|-----------|-----------|-----------|-----------|-----------|-----------|-----------|-----------|-----------|-----------|-----------|-----------|
| 50001 | 50002 | 50005 | 50006 | 50048 | 50005 | 50061 | 50051 | 50062 | 50063 | 50014 | 50010 | 50064 |
|-----------|-----------|-----------|-----------|-----------|-----------|-----------|-----------|-----------|-----------|-----------|-----------|-----------|

6 Positions

| | | | | | |
|-----------|-----------|-----------|-----------|-----------|-----------|
| 60001 | 60002 | 60015 | 60019 | 60016 | 60020 |
|-----------|-----------|-----------|-----------|-----------|-----------|

7 Positions

| | | |
|-----------|-----------|-----------|
| 70001 | 70002 | 70007 |
|-----------|-----------|-----------|

8 Positions

| | | | | | | | | |
|-----------|-----------|-----------|-----------|-----------|-----------|-----------|-----------|-----------|
| 80004 | 80005 | 80003 | 80001 | 80002 | 80006 | 80007 | 80008 | 80023 |
|-----------|-----------|-----------|-----------|-----------|-----------|-----------|-----------|-----------|

Blank

| |
|-----------|
| 00000 |
|-----------|

Locking Programs

La linea di riferimento indica la posizione in cui il commutatore è bloccato e la chiave è estratta.
The reference line shows where the switch is blocked and the key is withdrawn.

| | | | | | | | | | | | | | | | | | | |
|--------|--------|--------|--------|--------|--------|--------|--------|--------|--------|--------|--------|--------|--------|--------|--------|--------|--------|--------|
| 01 | 02 | 03 | 04 | 05 | 06 | 07 | 08 | 09 | 10 | 11 | 12 | 13 | 14 | 15 | 16 | 17 | 18 | 19 |
| 27 | 28 | | | | | | | | | | | | | | | | | |

Form for special diagram

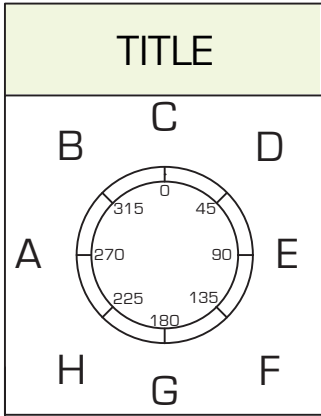

| Position Engraving | |
|--------------------|-----------|
| Position | Engraving |
| TITLE | |
| A | |
| B | |
| C | |
| D | |
| E | |
| F | |
| G | |
| H | |

| | | | | | | | | | |
|---------------|--------------------------|--------------------------|--------------------------|--------------------------|--------------------------|--------------------------|--------------------------|--------------------------|--------------------------|
| Lock in Pos. | <input type="checkbox"/> | <input type="checkbox"/> | <input type="checkbox"/> | <input type="checkbox"/> | <input type="checkbox"/> | <input type="checkbox"/> | <input type="checkbox"/> | <input type="checkbox"/> | <input type="checkbox"/> |
| Spring Return | <input type="checkbox"/> | <input type="checkbox"/> | <input type="checkbox"/> | <input type="checkbox"/> | <input type="checkbox"/> | <input type="checkbox"/> | <input type="checkbox"/> | <input type="checkbox"/> | <input type="checkbox"/> |
| Positions | | | | | | | | | |
| A | B | C | D | E | F | G | H | | |

| Contacts | |
|----------|--|
| 1 | |
| 2 | |
| 3 | |
| 4 | |
| 5 | |
| 6 | |
| 7 | |
| 8 | |
| 9 | |
| 10 | |
| 11 | |
| 12 | |
| 13 | |
| 14 | |
| 15 | |
| 16 | |
| 17 | |
| 18 | |
| 19 | |
| 20 | |
| 21 | |
| 22 | |
| 23 | |
| 24 | |

Switch Action :

Stayput Spring return Stayput and Spring return

Specification:.....

Model number:

Ordering Code : (it will provided by COMELETRIC)

Accessories / Informations:

| | | |
|--|---|--|
| Panel Mounting <input type="checkbox"/> | Pistol Grip Handle <input type="checkbox"/> | Key Lock (Different Keys) <input type="checkbox"/> |
| Base Mounting <input type="checkbox"/> | Padlockable <input type="checkbox"/> | Electromechanical interlock <input type="checkbox"/> |
| Gilded Contacts <input type="checkbox"/> | Mechanical Indicator (only for Spring Return Switches) <input type="checkbox"/> | Led Indicator <input type="checkbox"/> |
| IP55 Front Protection <input type="checkbox"/> | Key Lock (Same Keys) <input type="checkbox"/> | Removable Knob <input type="checkbox"/> |
| Push to Operate <input type="checkbox"/> | Pull to Operate <input type="checkbox"/> | Master Key <input type="checkbox"/> |

Legenda Symbols

| | | | |
|--|--|--|-----------------------------------|
| | Closed Contact | | Spring Return |
| | Closed Contact Two consecutive Positions | | Spring Return from Left and Right |
| | Make Before Break Contacts | | |
| | Dragged Contact | | |

BR001 Models:

Designed for the Circuit Breaker control. It consists of two main groups of contacts and a dragging joint. The group dragged contacts is used as an alarm or indication.

Progettato per il comando interruttore. Esso è formato da due gruppi di contatti uno principale ed uno trascinato. Il gruppo contatti trascinato viene utilizzato come allarme o indicazione.

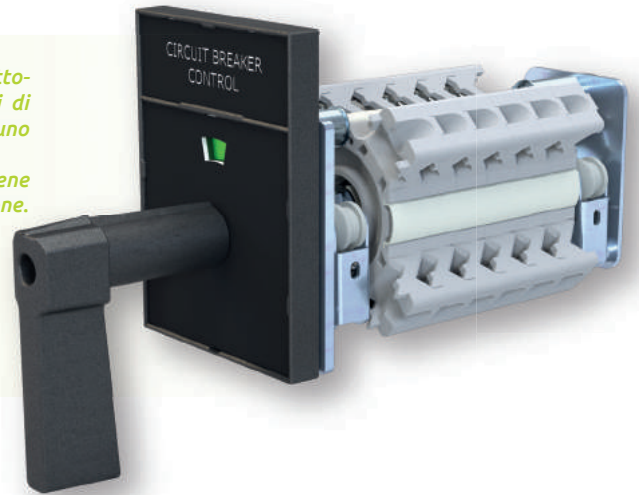

Dimensions

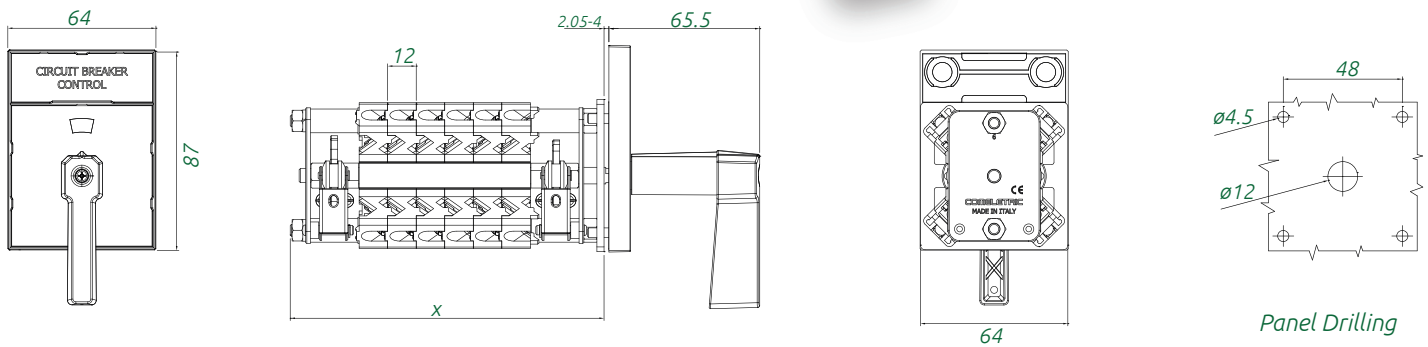

| N° of packets | 2 | 3 | 4 | 5 | 6 | 7 | 8 | 9 | 10 | 11 | 12 |
|---------------|-----|-----|-----|-----|-----|-----|-----|-----|-----|-----|-----|
| Length (mm) | 110 | 122 | 134 | 146 | 158 | 170 | 182 | 194 | 206 | 218 | 230 |

BR001 Frontplates BR001 Mostrine

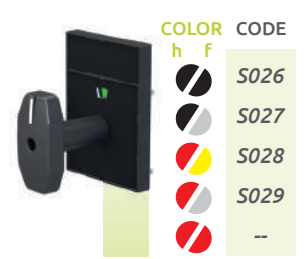
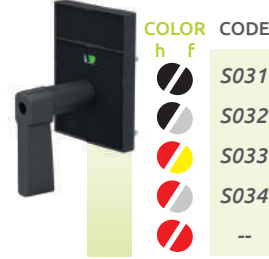
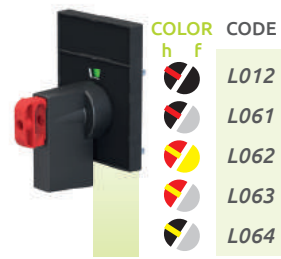
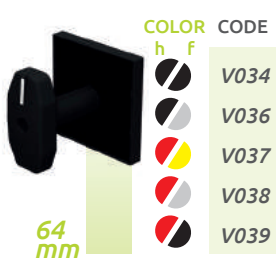
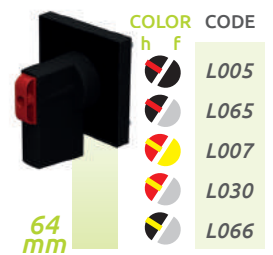
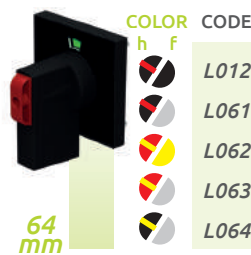
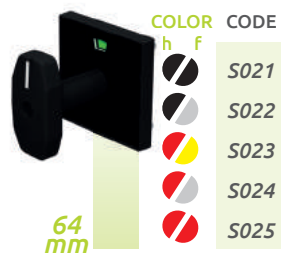

h=handle; f=frontplate
h=manopola; f=mostrina
Frontplate dimension on page 37/38
Dimensioni frontali a pag. 37/38

Switches with Dragging contacts Function and Configuration

N.A. = Normal After

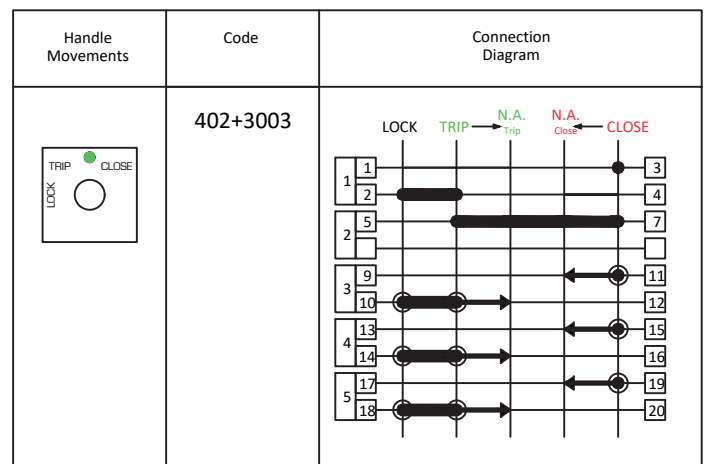
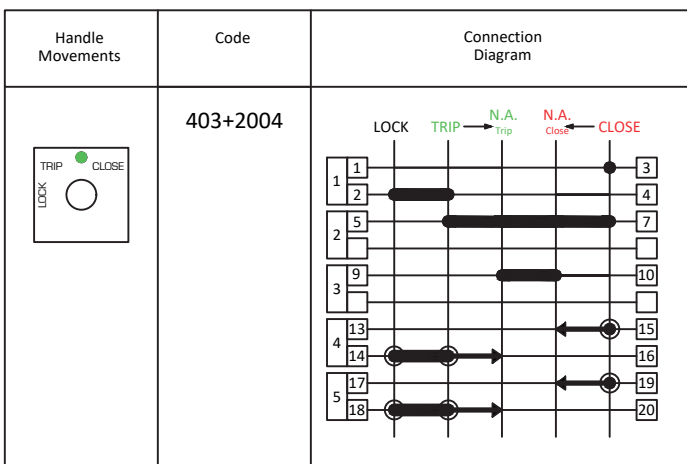
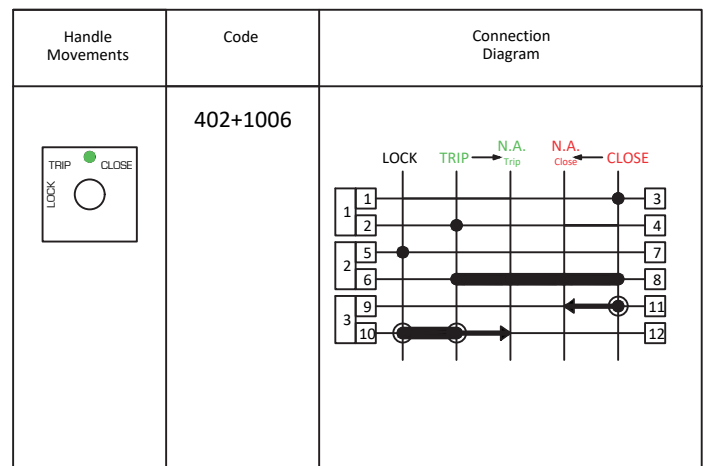
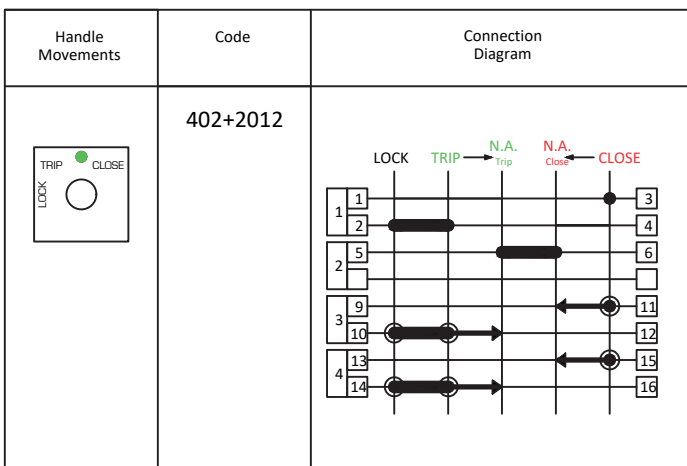
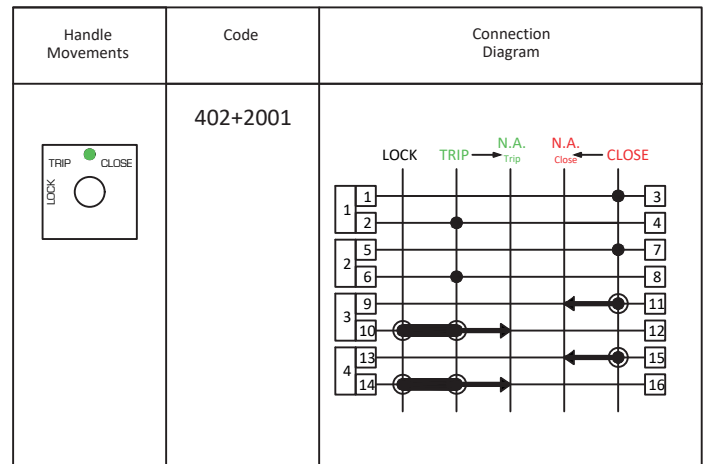
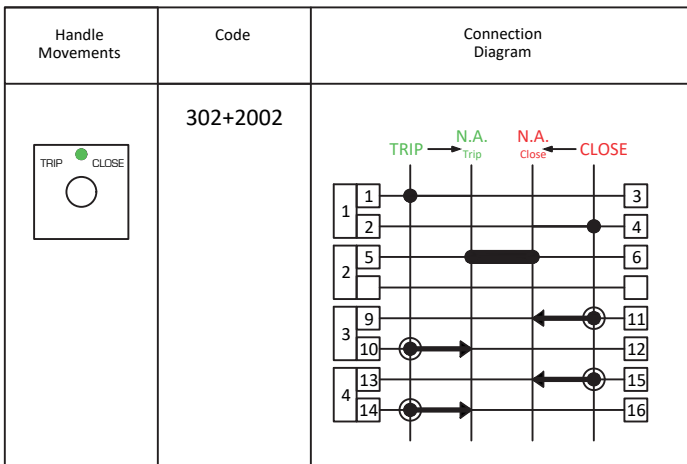
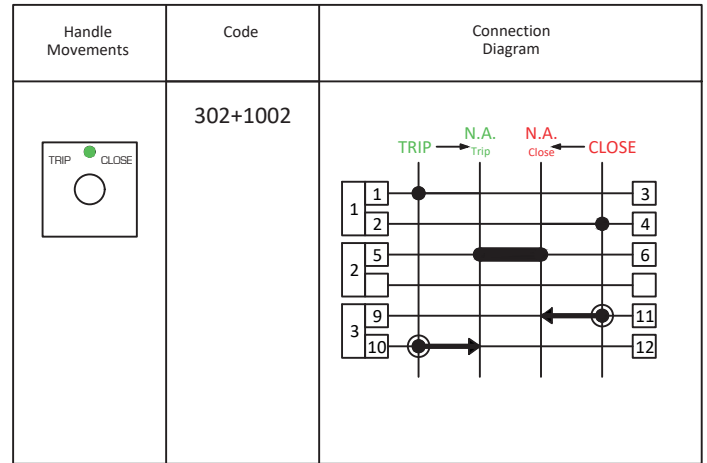
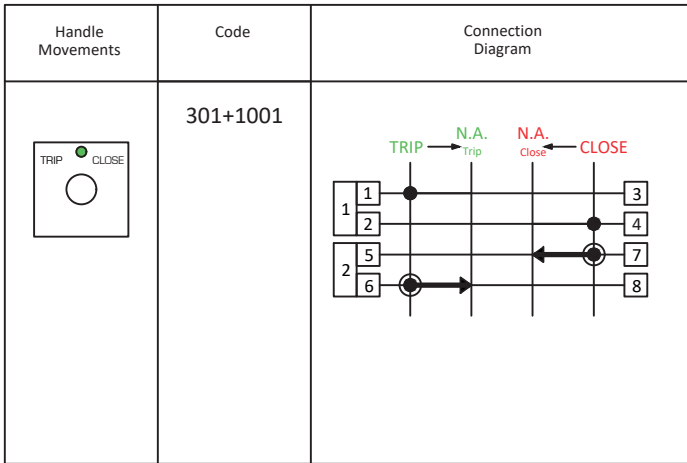

Wing Handle 48x48
Manopola Wing 48x48

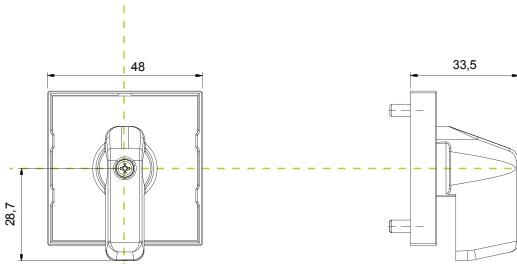

Wing Handle 64x64
Manopola Wing 64x64

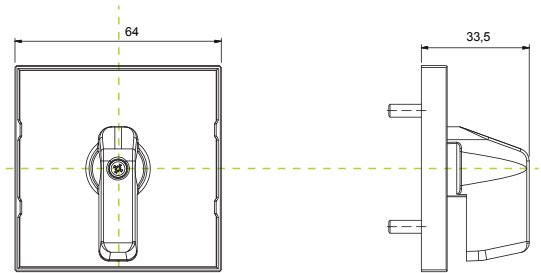

Pistol Grip Handle 48x48
Manopola Pistola 48x48

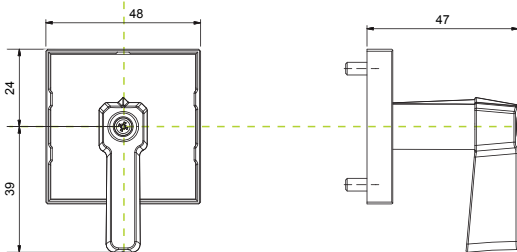

Big Pistol Grip Handle 64x64 (Trip Indicator)
Manopola Pistola Grande 64x64

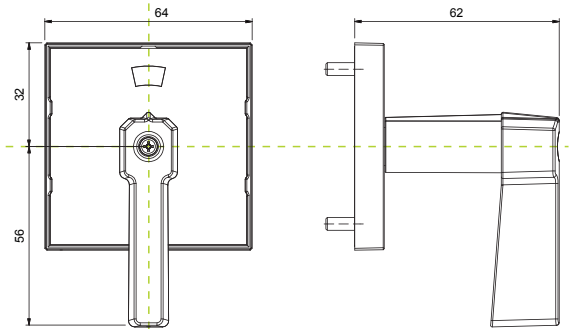

Key Operated 48x48
Operatore a Chiave 48x48

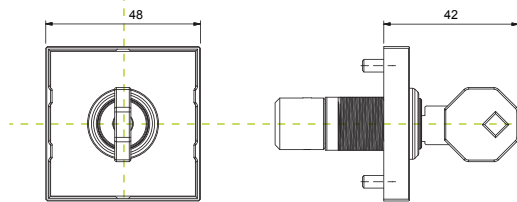

Padlockable 48x48
Manopola Lucchettabile 48x48

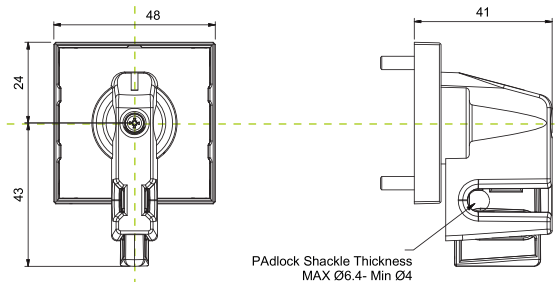

Small Padlockable 48x48
Lucchettabile Piccola 48x48

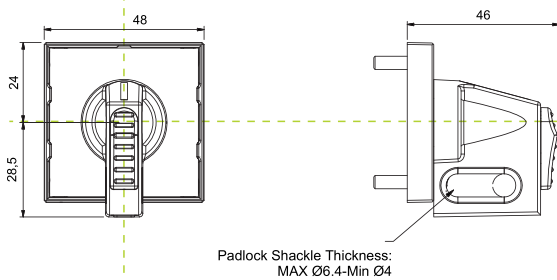

Big Oval Handle 64x64
Manopola Ovale Grande 64x64

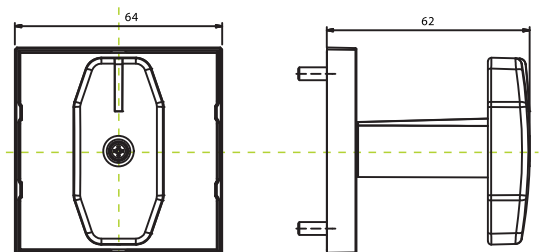

Big Pistol Grip Handle 48x48
Manopola a Pistola Grande 48x48

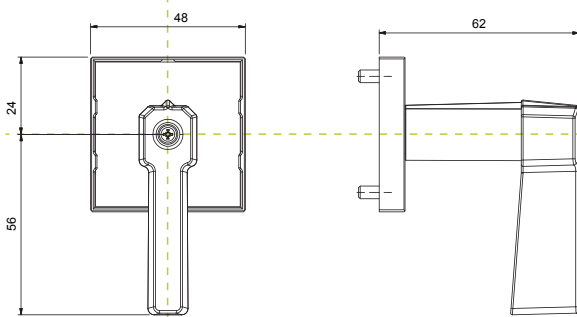

Big Padlockable Handle 64x64
Manopola Lucchettabile Grande 64x64

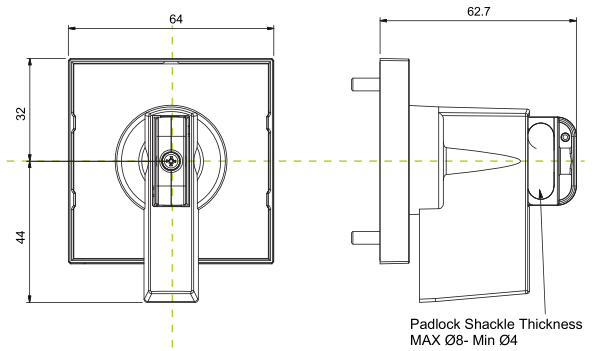

Key Operated 64x64
Operatore a Chiave 64x64

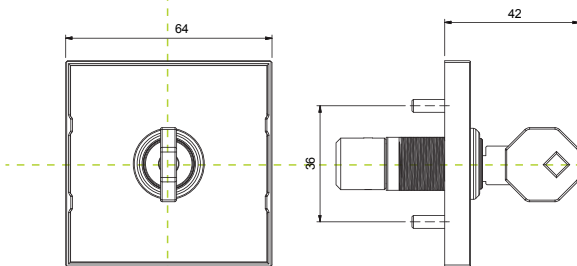

Small Oval Handle 48x48
Manopola Ovale Piccola 48x48

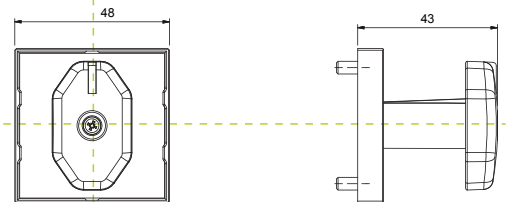

Small Pistol Grip Handle 64x64
Manopola a Pistola Piccola 64x64

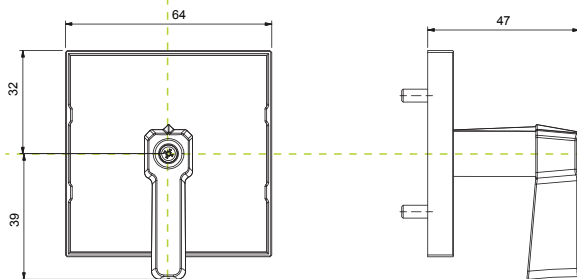

Big Padlockable Handle 64x64 (Trip Indicator)
Manopola Lucchettabile Grande 64x64

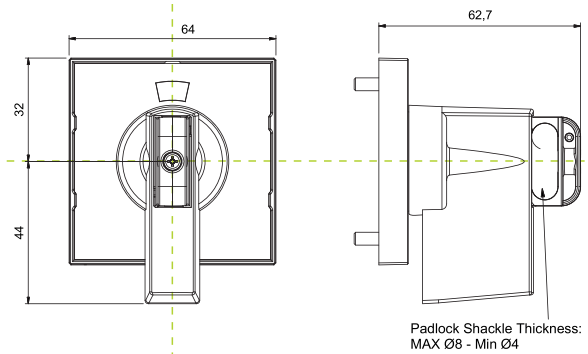

Big Oval Handle 48x48
Manopola Ovale Grande 48x48

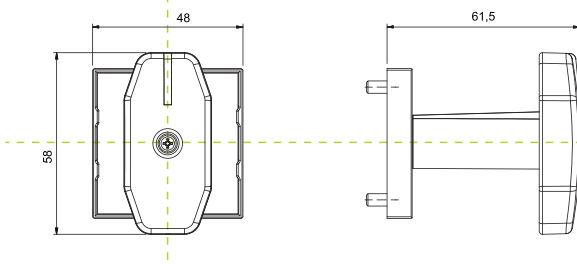

DR110 Discrepancy Switches Models:

Discrepancy switch.

New fitting system facilitated by the 5 holes.

Escutcheon plates available in different colours.

Manipolatore comando conferma.

Il nuovo sistema di fissaggio al pannello a 5 fori agevola l'operazione di fissaggio. Targhette disponibili in varie colorazioni.

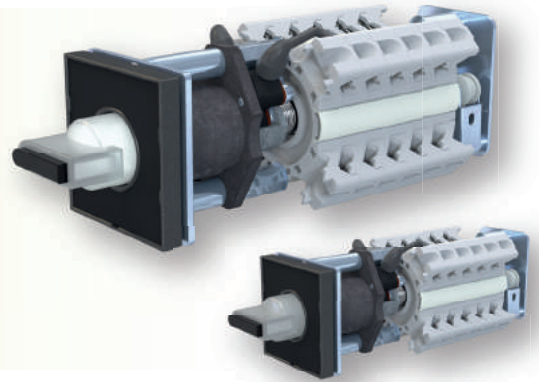

Dimensions

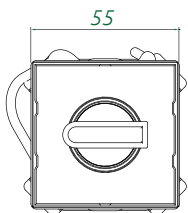

Square Frontplate

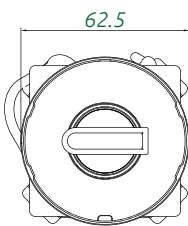

Round Frontplate

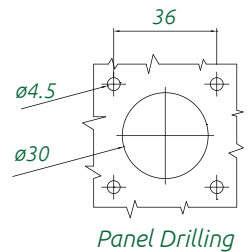
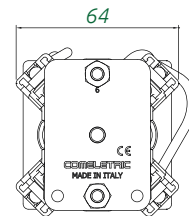
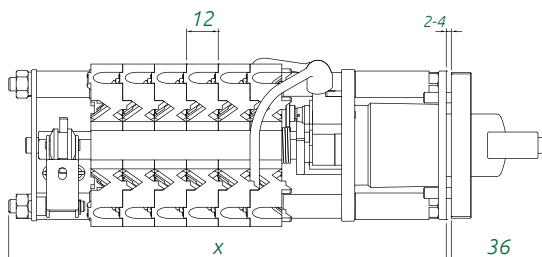

Panel Drilling

| N° of packets | 1 | 2 | 3 | 4 | 5 | 6 | 7 | 8 | 9 | 10 | 11 | 12 |
|---------------|-----|-----|-----|-----|-----|-----|-----|-----|-----|-----|-----|-----|
| Length (mm) | 129 | 141 | 153 | 165 | 177 | 189 | 201 | 213 | 223 | 237 | 249 | 261 |

DR110 Frontplates DR110 Mostrine

COLOR
h s f

CODE

- Q010
- Q020
- Q108
- Q116
- Q124
- Q132
- Q140
- Q148

55 mm

COLOR
h s f

CODE

- T010
- T020
- T108
- T116
- T124
- T132
- T140
- T148

Ø62 mm

COLOR
h s f

CODE

- Q044
- Q052
- Q060
- Q068
- Q076
- Q084
- Q092
- Q100

55 mm

COLOR
h s f

CODE

- T044
- T052
- T060
- T068
- T076
- T084
- T092
- T100

Ø62 mm

COLOR
h f

CODE

-
-
-
-
-

COLOR
h f

CODE

-
-
-
-
-

COLOR
h f

CODE

-
-
-
-
-

h=handle; f=frontplate
s=strip; s=striscia
h=manopola; f=mostrina

DR115 Discrepancy Switches Models:

Discrepancy switch.

New fitting system facilitated by the 5 holes.

Escutcheon plates available in different colours.

Frontplate size

mm 48x48 or

Ø mm 48

Manipolatore comando conferma.

Il nuovo sistema di fissaggio al

pannello a 5 fori agevola

l'operazione di fissaggio. Targhette

disponibili in varie colorazioni.

Misure mostrine

48x48 mm oppure

Ø 48 mm

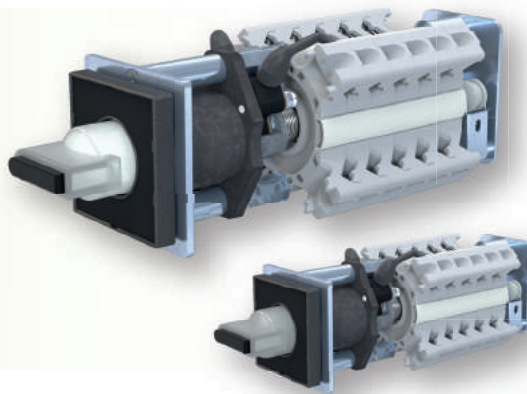

Dimensions

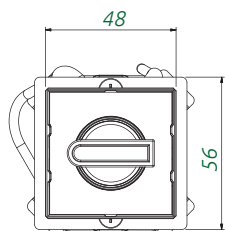

Square Frontplate

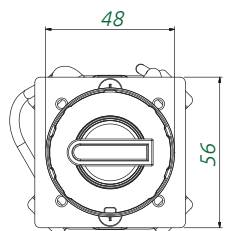

Round Frontplate

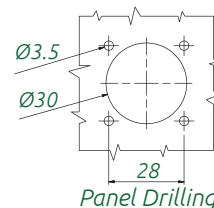
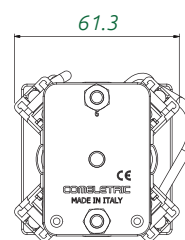
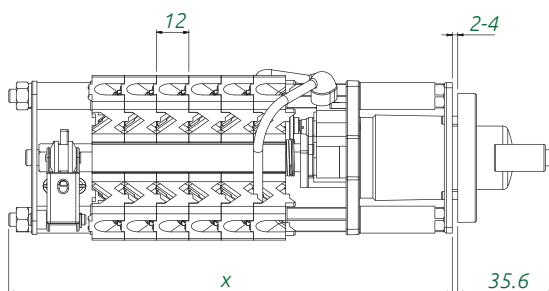

| N° of packets | 1 | 2 | 3 | 4 | 5 | 6 | 7 | 8 | 9 | 10 | 11 | 12 |
|---------------|-----|-----|-----|-----|-----|-----|-----|-----|-----|-----|-----|-----|
| Length (mm) | 129 | 141 | 153 | 165 | 177 | 189 | 201 | 213 | 223 | 237 | 249 | 261 |

DR115 Frontplates DR115 Mostrine

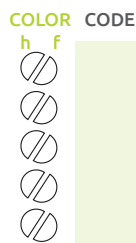
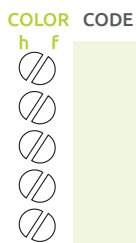
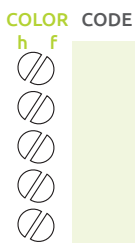
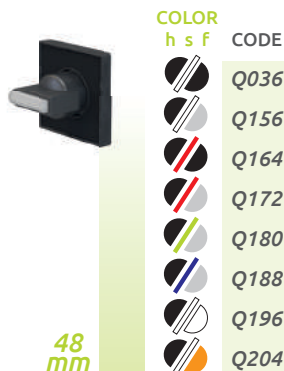
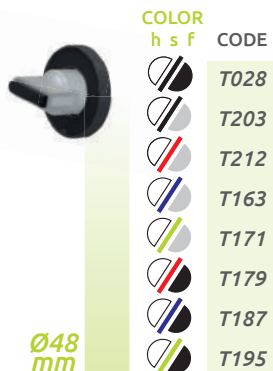
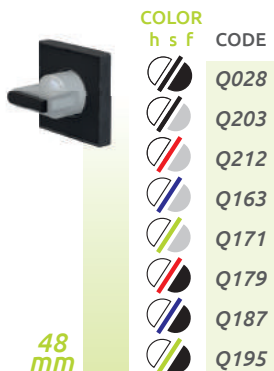

h=handle; f=frontplate
s=strip; s=striscia
h=manopola; f=mostrina

Discrepancy Switch Function and Configuration

| Function | Handle Movements | Decks | Code | Connection Diagram |
|----------|------------------|-------|------|--------------------|
|----------|------------------|-------|------|--------------------|

Indication the position of the CB or DS

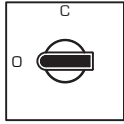
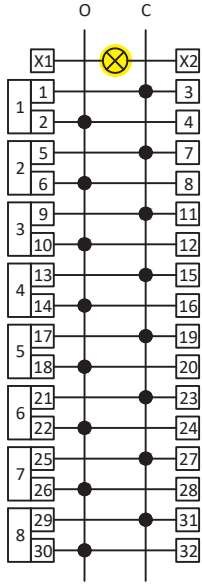
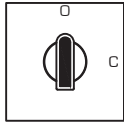
| | | | | |
|--|---|--------------------------------------|--|--|
| 1 pole 2 pole 3 pole 4 pole 5 pole 6 pole 7 pole 8 pole |  | 1 2 3 4 5 6 7 8 | A01001 A02001 A03001 A04001 A05001 A06001 A07001 A08001 |  |
| 1 pole 2 pole 3 pole 4 pole 5 pole 6 pole 7 pole 8 pole |  | 1 2 3 4 5 6 7 8 | A01003 A02003 A03003 A04003 A05003 A06003 A07003 A08003 | |

Indication the position of the CB or DS

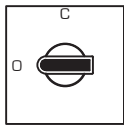
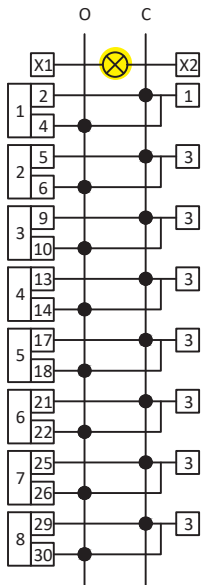
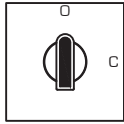
| | | | | |
|--|---|--------------------------------------|--|---|
| 1 pole 2 pole 3 pole 4 pole 5 pole 6 pole 7 pole 8 pole |  | 1 2 3 4 5 6 7 8 | B01001 B02001 B03001 B04001 B05001 B06001 B07001 B08001 |  |
| 1 pole 2 pole 3 pole 4 pole 5 pole 6 pole 7 pole 8 pole |  | 1 2 3 4 5 6 7 8 | B01003 B02003 B03003 B04003 B05003 B06003 B07003 B08003 | |

Discrepancy Switch Function and Configuration

| Function | Handle Movements | Decks | Code | Connection Diagram |
|----------|------------------|-------|------|--------------------|
|----------|------------------|-------|------|--------------------|

Control and indication of CB or DS

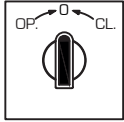
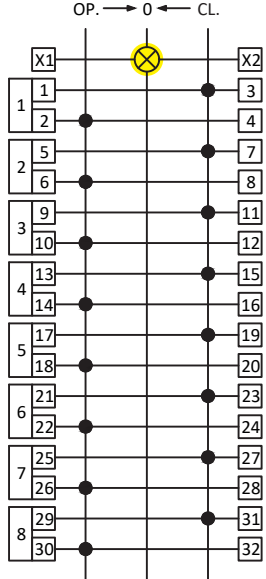
| | | | | |
|--|---|--------------------------------------|--|--|
| 1 pole 2 pole 3 pole 4 pole 5 pole 6 pole 7 pole 8 pole |  | 1 2 3 4 5 6 7 8 | C01001 C02001 C03001 C04001 C05001 C06001 C07001 C08001 |  |
|--|---|--------------------------------------|--|--|

Control and indication of CB or DS

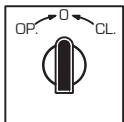
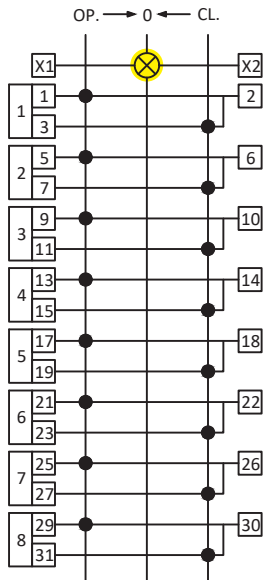
| | | | | |
|--|---|--------------------------------------|--|---|
| 1 pole 2 pole 3 pole 4 pole 5 pole 6 pole 7 pole 8 pole |  | 1 2 3 4 5 6 7 8 | C01003 C02003 C03003 C04003 C05003 C06003 C07003 C08003 |  |
|--|---|--------------------------------------|--|---|

Discrepancy Switch Function and Configuration

Principio di operazione Tipo : D ed E

I manipolatori con l'azionamento tipo D ed E sono tipicamente chiamati Manipolatori di comando e segnalazione di discordanza.

Questi Manipolatori Hanno 2pos. con spostamento di 90° e 2 extra impulsi di 45° per il comando di Apertura e di chiusura.

La manopola viene ruotata di 90° per comandare il relativo Interruttore /Sezionatore.

Questa tuttavia e' solamente una fase di preselezione del comando , il comando viene confermato tramite la pressione della manopola e la relativa rotazione , una volta rilasciata la manopola essa ritorna automaticamente nella relativa posizione.

Principle of operation Type : D and E

The switches with the movements type D and E are basically called control discrepancy switches.

The control discrepancy switch has two fixed positions with a movement of 90° and two extra impulses of 45° on the positions of open and close.

The knob is first rotated by 90° to command the relative Disconnecter Switch/Circuit Breaker.

This is however, a "pre-selection" phase of the desired command , the operation is confirmed by pressing and rotating the knob by 45°, which, once released, will return automatically into position.

| Handle Movements | Code | Connection Diagram | Handle Movements | Code | Connection Diagram |
|------------------|----------|--------------------|------------------|----------|--------------------|
| | D02001 | | | D02006 | |
| | D02008 | | | D02009 | |
| | D03001 | | | D03002 | |
| | D03008 | | | D03015 | |
| | D0300621 | | | D0300612 | |
| | D0301821 | | | D0301812 | |

Discrepancy Switch Function and Configuration

| Handle Movements | Code | Connection Diagram | Handle Movements | Code | Connection Diagram |
|------------------|--------|--------------------|------------------|--------|--------------------|
| | D04001 | | | D04002 | |
| | D04008 | | | D04015 | |
| | E04001 | | | D05001 | |
| | XXXXX | | | D05008 | |
| | D05002 | | | D06001 | |
| | D05015 | | | D06008 | |
| | D06002 | | | E06001 | |
| | D06015 | | | XXXXXX | |

Discrepancy Switch Function and Configuration

La mostrina si intende parte integrante del commutatore in quanto necessaria per il fissaggio al pannello dello stesso, se non specificata nessuna incisione essa verrà fornita Neutra, codice 00000.

The Escutcheon plate is strictly necessary for fitting the switch to the panel, if none engraving is specified, the frontplate will be supplied Blank, code 00000. The engraving listed below, are only a little part of those available, require the code of the needed one if not present.

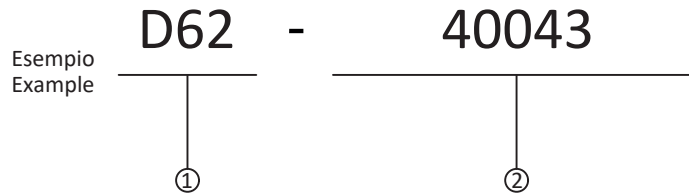

① Dimensions and shape of the Escutcheon Plate for Discrepancy Switches.

48= 48x48mm Square / Quadra

D48= 48mm Round / Tonda

55= 55x55mm Square / Quadra

D62= 62.5mm Round / Tonda

②

2 Positions

| | | | | | | | | | |
|--|--|--|--|--|--|--|--|--|--|
| | | | | | | | | | |
| | | | | | | | | | |

3 Positions

| | | | | | | | | | |
|--|--|--|--|--|--|--|--|--|--|
| | | | | | | | | | |
|--|--|--|--|--|--|--|--|--|--|

4 Positions

| | | | | | | | | | |
|--|--|--|--|--|--|--|--|--|--|
| | | | | | | | | | |
| | | | | | | | | | |
| | | | | | | | | | |

Gilded Contacts
Contatti Dorati

Description
Descrizione



To Improve the reliability and the performances, even in the most aggressive environments, contacts can be supplied with special surface treatments, such as gold with thickness certificate.

Per migliorare l'affidabilità e le prestazioni anche negli ambienti più aggressivi, è possibile fornire i contatti con speciali trattamenti superficiali, con spessori Certificati (es. oro).

Legend Label
Mostrina Addizionale Titolo

Description
Descrizione

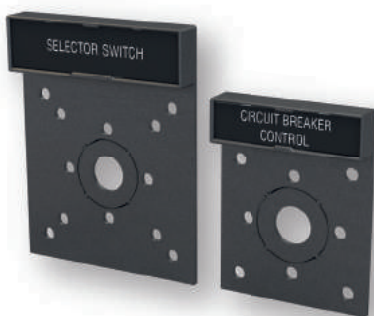

It shows the function of the switch. Available for frontplates sized mm.48x48 and mm.64x64. It does not require any extra drilling on the panel.

Indica la funzione specifica del singolo commutatore disponibile per mostrina mm.48x48 e per mostrina mm.64x64. Non necessita nessuna foratura pannello supplementare per il fissaggio.

Led Indicator
Indicatori a Led

Description
Descrizione



On demand it can be supplied with 1 or 2 LED positioned on the plate, suitable for a light indication.

Su richiesta possono essere forniti 1 o 2 indicatori LED applicati sulla mostrina da utilizzare come indicazione luminosa.

IP55 Protection
Guarnizioni IP55

Description
Descrizione

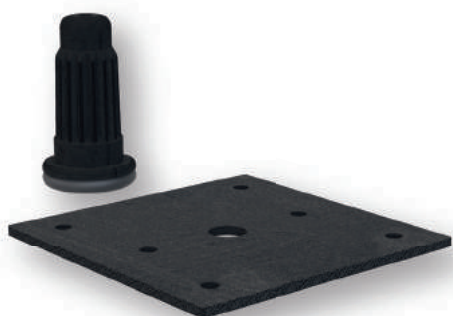

To ensure IP55 degree protection in the front of the switch, a gum plate is provided to be fitted below the frontplate Holder (not available for R104/R107).

Per assicurare il grado di protezione IP55 sul fronte del commutatore, viene fornita una guarnizione in gomma posta sotto il portamostrina (non disponibile per R104/R107).

**STANDARD UTILIZATION CATEGORIES
CATEGORIE DI UTILIZZO NORMALIZZATE**

| Kind of current Tipo di corrente | Category Categoria | Typical applications Applicazioni tipiche |
|---|-----------------------|--|
| Alternative current Corrente alternata | AC14 | Control of small electromagnetic load with rated power = 72VA Comando di piccoli carichi elettromagnetici con potenza = 72VA |
| | AC15 | Control of electromagnetic load with rated power > 72VA Comando di carichi elettromagnetici con potenza > 72VA |
| | AC22 | Switching of mixed resistive and inductive loads , including moderate overload Manovra di carichi misti , resistivi e induttivi con sovraccarichi di modesta entità |
| | AC23 | Switching of motor loads or other highly inductive loads Manovra di motori o altri carichi altamente induttivi. |
| Direct current Corrente continua | DC13 | Control of electromagnets Comando di elettromagneti |
| | DC14 | Control of electromagnetic loads having economy resistor in circuit Comando di carichi elettromagnetici aventi resistori economizzatori nel circuito |
| | DC21 | Switching of resistive loads including moderate overloads Manovra di carichi resistivi con sovraccarichi di moderata entità |
| | DC23 | Switching of highly inductive loads (e.g. Series Motor) Manovra di carichi altamente induttivi (es. Motori in serie) |

| NORMAL CONDITIONS CONDIZIONI NORMALI | | | | |
|---|------------------|-----------------------|------|------------------------|
| Utilization category Categoria utilizzazione | Make Chiusura | Break Interruzione | U/Ue | cos Φ |
| | I/le | I/le | | |
| AC14 | 6 | 1 | 1 | 0.3 |
| AC15 | 10 | 1 | 1 | 0.3 |
| AC22 | 1 | 1 | 1 | 0.8 |
| AC23 | 1 | 1 | 1 | 0.65 |
| | | | | T _{0.95} [ms] |
| DC13 | 1 | 1 | 1 | 6xP |
| DC14 | 10 | 1 | 1 | 15 |
| | | | | L/R ms |
| DC21 | 1 | 1 | 1 | 1 |
| DC23 | 1 | 1 | 1 | 7.5 |

| ABNORMAL CONDITIONS CONDIZIONI ANOMALE | | | |
|---|-----------------------|------|------------------------|
| Make Chiusura | Break Interruzione | U/Ue | cos Φ |
| | | | |
| 6 | 6 | 1.1 | 0.7 |
| 10 | 10 | 1.1 | 0.3 |
| 3 | 3 | 1.05 | 0.65 |
| 10 | 8 | 1.05 | 0.45 |
| | | | T _{0.95} [ms] |
| 1.1 | 1.1 | 1.1 | 6xP |
| 10 | 10 | 1.1 | 15 |
| | | | L/R ms |
| 1.5 | 1.5 | 1.05 | 1 |
| 4 | 4 | 1.05 | 15 |

- I / I_e : Current to be made or broken and Rated operational current ratio;
rapporto tra la corrente che l'apparecchiatura è in grado di stabilire o interrompere e la corrente d'impiego;
- U / U_e : Voltage before make and Rated operational voltage ratio;
rapporto tra la tensione prima della chiusura e la tensione d'impiego;
- T_{0.95}: Time to reach 95% of the steady-state current;
Tempo per raggiungere il 95% della corrente di regime;
- P=U_e x I_e: steady-state power consumption in W;
potenza assorbita a regime in W;

The value "6xP" result from empirical relationship which is found to represent most d.c. magnetic loads to an upper limit of P =50W, i.e. 6 x P=300 ms. Load having power -consumption greater than 50 W are assumed to consist of smaller loads in parallel. Therefore,300 ms is to be an upper limits irrespective of the power. **[REFERENCE STANDARD IEC 947-5-1 tab. 5].**

La relazione matematica "6xP" è valida per tutti carichi induttivi rappresentativi fino ad un massimo di P pari a 50W cioè 6xP = 300ms. Si assume che i carichi aventi una potenza assorbita superiore a 50W siano costituiti da piccoli carichi in collegati in parallelo di conseguenza 300ms è il valore massimo a prescindere dalla potenza assorbita. **[RIFERIMENTO NORMA CEI EN 60947-5-1 tab. 5]**

**RATED ELECTRICAL CHARACTERISTICS
CARATTERISTICHE ELETTRICHE NOMINALI**

| | | |
|--|--|------|
| According to standards Conformità alle norme | IEC 60947-3 - IEC 60947-5-1 - IEC 60947-1 - CEI EN 60947-3 - CEI EN 60947-5-1 - CEI EN 60947-1 - VDE 0660-100 - VDE 0660-107 - VDE 0660200 - 2006/95/EC (Low Voltage Directive) - 2004/108/EC (EMC Directive) - 20011/65/EU (ROHS Directive) | |
| Conventional free air thermal current Corrente convenzionale termica in aria | (I _{th}) | 25A |
| Rated insulation voltage Tensione di isolamento nominale | (U _i) | 690V |
| Rated impulse withstand voltage Tensione di tenuta ad impulso nominale | (U _{imp}) | 4Kv |
| Dielectric test voltage corresponding to the rated insulation Voltage Tensione di prova corrispondente alla tensione di isolamento nominale | 2500 V/60s (50Hz) | |
| Frequency Frequenza di impiego | 50/60Hz | |

**RELEVANT INFORMATIONS ABOUT THE ASSOCIATED SHORT CIRCUIT PROTECTIVE DEVICE
DATI RELATIVI AL DISPOSITIVO DI PROTEZIONE CONTRO IL CORTO CIRCUITO ASSOCIABILE**

| | |
|---|----------------------|
| Rated conditional short-circuit current (Max Peak current) Massima Corrente di picco ammissibile | 1550A |
| Rated Maximum Joule integral Integrale di Joule massimo | 38 kA ² s |
| Rated Short.time current Corrente nominale di breve durata (1s) (I _{cw}) | 300 A |
| Contact Resistance Resistenza di contatto | 2.5 mΩ |

**MAKING AND BREAKING CAPACITIES
POTERI DI CHIUSURA ED INTERRUZIONE**

| Categoria di utilizzazione Utilization Category | (U _e) | (I _e) |
|--|-------------------|-------------------|
| AC14 | 400 V | 16 A |
| AC15 | 400 V | 10 A |
| A 22A (3 poli - 3 phase) | 415 V | 25 A |
| AC 23A (3 poli - 3 phase) | 415 V | 20 A |
| DC13 | 220 V | 6 A |
| DC14 | 110 V 250 V | 6 A 2.5 A |
| DC21A | 220 V | 16 A |
| DC23A | 220 V | 6 A |

**RESISTANCE TO SHOCK AND VIBRATION (IEC 61373 - CEI EN 61373 Railway applications, Rolling stock equipment)
RESISTENZA VIBRAZIONI E URTI (IEC 61373 - CEI EN 61373 Applicazioni ferroviarie, materiale rotabile).
(Excluding models DR110-DR115) - (Esclusi i modelli DR110-DR115)**

| | |
|---|--|
| Vibration resistance Resistenza alla vibrazione | Vibration Range: 5 to 150Hz, Acceleration: 5,72m/s ² , Time: 5h (in 3 directions) Range di frequenza da 5 a 15Hz, Accelerazione: 5,72m/s ² , Tempo: 5h (in 3 direzioni) |
| Shock resistance Resistenza agli urti | Acceleration: 50m/s ² (in 6 directions) , Time: 30ms Accelerazione: 50m/s ² (in 6 direzioni) , Tempo: 30ms |



Recommended tightening torque to avoid thread stripping
Don't exceed torque more than indicated.

Coppia di serraggio consigliata per evitare di rovinare il filetto della vite
Non superare la coppia più di quanto indicato.

| | |
|---|--|
| Conneting screw Vite di contatto terminale | M 3.5 |
| Tightening torque Coppia serraggio viti | (Nm) 1.2 |
| Permissible wire gage Sezione del conduttore | |
| Single - core or stranded wire Cavo rigido o intrecciato | (mm ²) 1.5 - 6 AWG15 - AWG9 |
| Flexible wire Cavo flessibile | (mm ²) 1.5 - 6 AWG15 - AWG9 |

**ENVIRONMENTAL DATA (IEC 60947-1 - CEI EN 60947-1)
DATI AMBIENTALI**

| | |
|---|-------------|
| Temperature range Temperatura ambientale | |
| Operating temperature Esercizio | -25°C +60°C |
| Storage temperature Stoccaggio | -40°C +80°C |

R167 Push Button Interlock Switch
R167 Interblocco a Pulsante

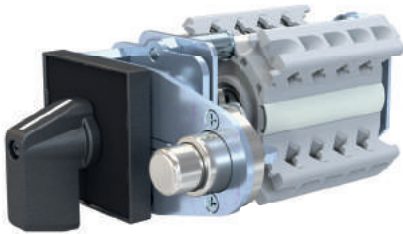

The switch can be handle only by pressing the push button (2 hands operation).

Il commutatore può essere manovrato solo premendo il pulsante di blocco (operazione a 2 mani).

SR106 Solenoid lock switch
SR106 con interblocco elettromeccanico

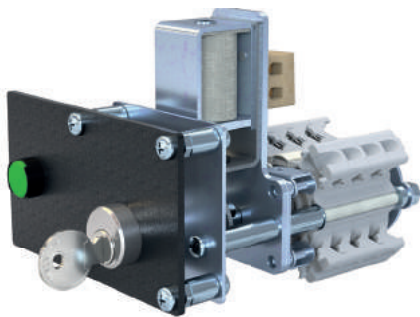

It is used as interlocking device for disconnect, circuit breaker, earth switches or to control the access to dangerous areas such as capacitor banks, etc.. The switch can be activated manually through a push button integrated in the front plate that controls the coil. At the end of this operation it is possible to remove the key.

REFERE TO INTERLOCKING DEVICE CATALOGUE.

L'apparecchio viene utilizzato come interblocco elettromagnetico per sezionatori, interruttori, sezionatori di terra o per regolamentare l'accesso a zone pericolose come banchi di condensatori, ecc. Il commutatore può essere azionato tramite comando manuale di un pulsante integrato nella mostrina che eccita la bobina, a fine operazione diventa possibile l'estrazione della chiave.
FARE RIFERIMENTO AL CATALOGO INTERBLOCCHI.

SR105 Solenoid lock switch
SR105 con interblocco elettromeccanico

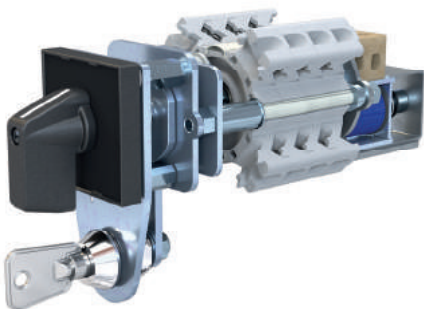

This is a special switch with a double block both mechanical and electrical, through the coil energized on the rear of it.

Questo commutatore sfrutta un doppio blocco meccanico ed elettrico, grazie all'eccitazione della bobina posta sul retro.

R101 Unidirectional Switch
R101 Rotazione unidirezionale

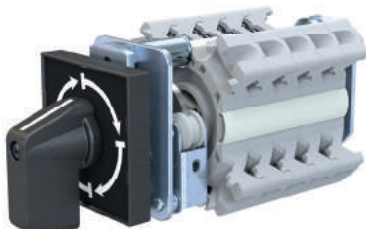

Available for switches with 4 positions at 90° or 8 positions at 45° It can be handled only clockwise or counterclockwise.

Disponibile per commutatori a 4 posizioni a 90° o 8 posizioni a 45°. Abilita la rotazione solamente in senso orario o antiorario.

C-R20 06/18

Via Ernesto Rizzi 13/H
20077 Melegnano (MI) Italia
T +39 02.98119791
info@comeletric.it
P iva 00868300153

COMELETRIC.IT

