

PIR3 with socket GZM3 interface relays

R3N (AC) + GZM3



R3N (DC) + GZM3



- Interface relay **PIR3 with socket GZM3** consists of: electromagnetic relay **R3N**, grey plug-in socket **GZM3**, signalling / protecting module type **M...**, retainer / retractor clip **GZT4-0040** (plastic), white description plate **GZT4-0035**
- 35 mm rail mount acc. to EN 60715 or on panel mounting with two M3 screws • May be linked with interconnection strip type **ZGGZ4**
- Recognitions, certifications, directives: recognitions R3N, RoHS,



Contact data

Number and type of contacts		3 CO
Contact material		AgNi
Rated / max. switching voltage	AC	250 V / 300 V
Min. switching voltage		5 V
Rated load (capacity)	AC1	10 A / 250 V AC
	AC15	3 A / 120 V 1,5 A / 240 V (B300)
	DC1	10 A / 24 V DC (see Fig. 3)
	DC13	0,22 A / 120 V 0,1 A / 250 V (R300)
Motor load	acc. to UL 508	1/2 HP 240 V AC, 4,9 FLA, single-phase motor ①
	AC3 acc. to IEC 60947-4-1	0,37 kW 240 V AC, single-phase motor
Min. switching current		5 mA
Max. inrush current		20 A
Rated current		10 A
Max. breaking capacity	AC1	2 500 VA
Min. breaking capacity		0,3 W
Contact resistance		≤ 100 mΩ
Max. operating frequency	• at rated load AC1 • no load	1 200 cycles/hour 18 000 cycles/hour

Coil data

Rated voltage	50/60 Hz AC	12, 24 , 48, 120, 230 V
	DC	12, 24 , 48, 110 V
Must release voltage		AC: ≥ 0,2 U _n DC: ≥ 0,1 U _n
Operating range of supply voltage		see Tables 1,2
Rated power consumption	AC	50 Hz: 1,6 VA 60 Hz: 1,3 VA
	DC	0,9 W

Insulation according to EN 60664-1

Insulation rated voltage		300 V AC
Rated surge voltage		4 000 V 1,2 / 50 μs
Overvoltage category		III
Insulation pollution degree		2
Dielectric strength	• between coil and contacts • contact clearance • pole - pole	2 500 V AC type of insulation: basic 1 500 V AC type of clearance: micro-disconnection 2 500 V AC type of insulation: basic
Contact - coil distance	• clearance • creepage	≥ 2,5 mm ≥ 4 mm

General data

Operating / release time (typical values)		AC: 10 ms / 8 ms DC: 13 ms / 3 ms
Electrical life	• resistive AC1 • cosφ	> 10 ⁵ 10 A, 250 V AC see Fig. 2
Mechanical life (cycles)		> 2 x 10 ⁷
Dimensions (L x W x H)		75 x 27 x 82 mm
Weight		105 g
Ambient temperature	• storage (non-condensation and/or icing)	-40...+85 °C
	• operating	AC: -40...+55 °C DC: -40...+70 °C
Cover protection category		IP 20 EN 60529
Environmental protection		R3N: RTI GZM3: RT0 EN 61810-7
Shock resistance	(NO/NC)	10 g / 5 g
Vibration resistance		5 g 10...150 Hz

The data in bold type relate to the standard versions of the relays.

① For single phase motors for 110-120 V AC do not use motors with higher FLA than given for 240 V AC.

PIR3 with socket GZM3 interface relays

Dimensions

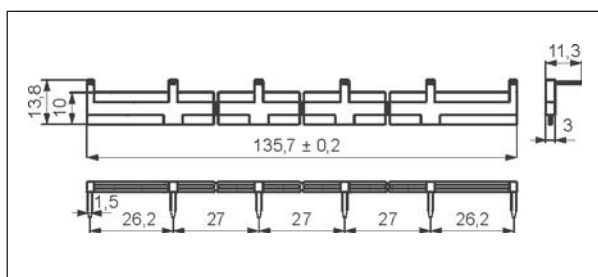
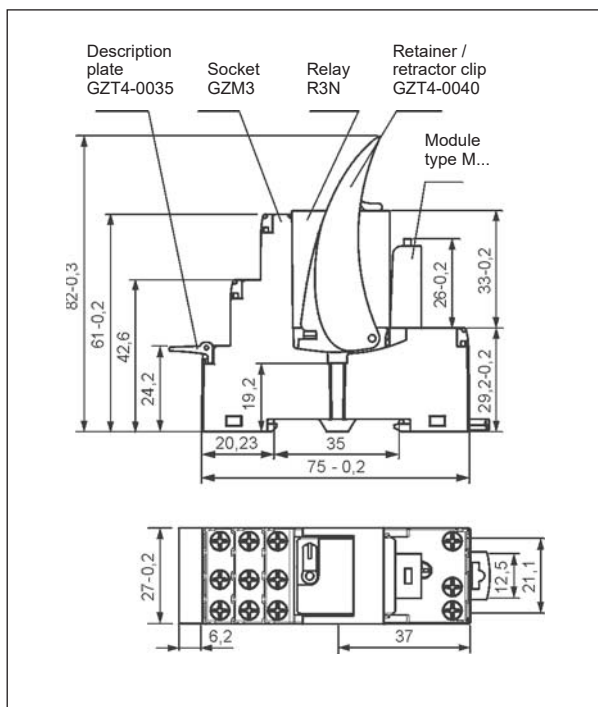

Interconnection strip type **ZGGZ4**

Mounting

Relays **PIR3 with socket GZM3** are designed for direct mounting on 35 mm rail mount acc. to EN 60715 or on panel mounting with two M3 screws. **Connections:** max. cross section of the cables (stranded): 2 x 2,5 mm² (2 x 14 AWG), stripping length: 6,5 mm, max. tightening moment for the terminal: 0,7 Nm.

Plug-in sockets **GZM3** may be linked with interconnection strip type **ZGGZ4**. Strip **ZGGZ4** bridges common input signals, maximum permissible current is 10 A / 250 V AC, possibility of connection of 6 sockets. Colours of strips: **ZGGZ4-1** grey, **ZGGZ4-2** black (see page 5).



Interconnection strip ZGGZ4:
bridging of common input signals.



ZGGZ4

Interface relays PIR2 (PIR3, PIR4)

set: relay R2N (R3N, R4N)
+ socket GZM2 (GZM3, GZM4)



PIR3 with socket GZM3 interface relays

Electrical life at AC resistive load.
Switching frequency: 1 200 cycles/hour

Fig. 1

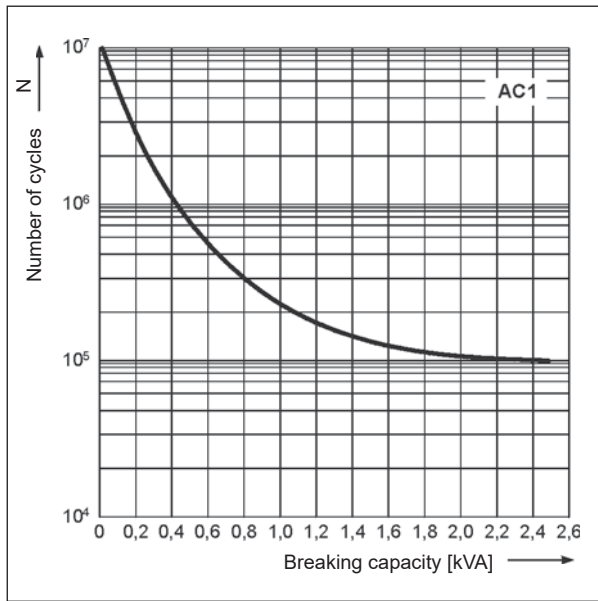

Electrical life reduction factor at AC inductive load

Fig. 2

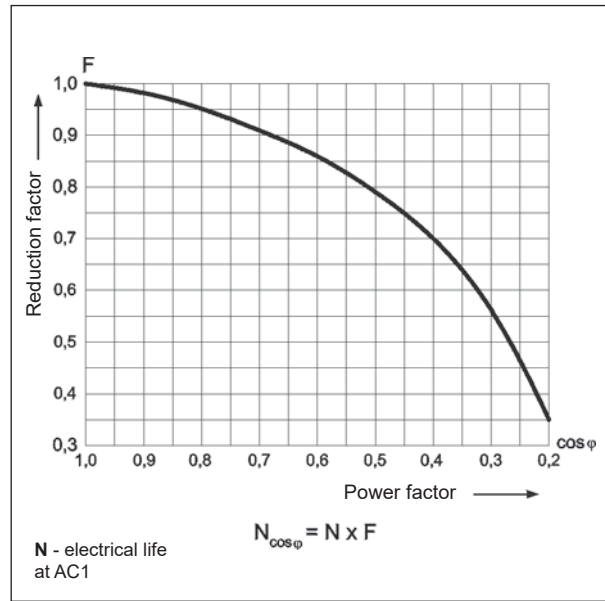

Max. DC breaking capacity
A - resistive load DC1
B - inductive load L/R = 40 ms

Fig. 3

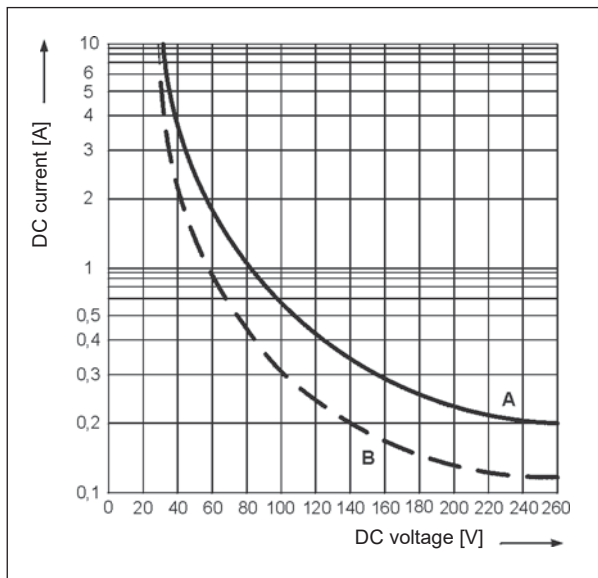

Connection diagrams
(screw terminals side view)

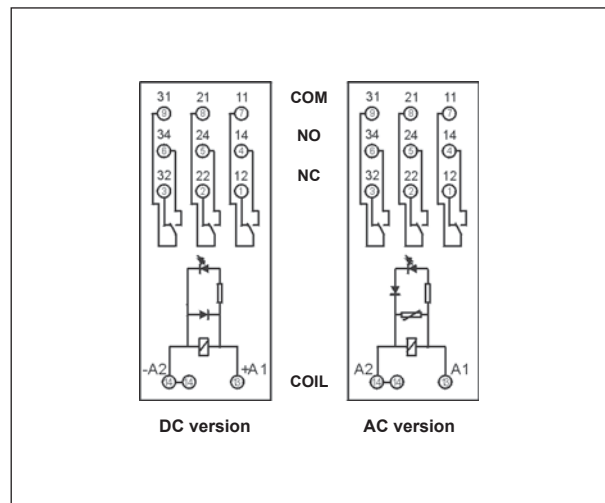

PIR3 with socket GZM3 interface relays

Coil data - DC voltage version

Table 1

Coil code	Rated voltage V DC	Coil resistance at 20 °C Ω	Acceptable resistance	Coil operating range V DC	
				min. (at 20 °C)	max. (at 70 °C)
012DC	12	160	± 10%	9,6	13,2
024DC	24	640	± 10%	19,2	26,4
048DC	48	2 600	± 10%	38,4	52,8
110DC	110	13 600	± 10%	88,0	121,0

The data in bold type relate to the standard versions of the relays.

Coil data - AC 50/60 Hz voltage version

Table 2

Coil code	Rated voltage V AC	Coil resistance at 20 °C Ω	Acceptable resistance	Coil operating range V AC	
				min. (at 20 °C)	max. (at 55 °C)
012AC	12	39,5	± 10%	9,6	13,2
024AC	24	158	± 10%	19,2	26,4
048AC	48	640	± 10%	38,4	52,8
120AC	120	3 770	± 10%	96,0	132,0
230AC	230	16 100	± 10%	184,0	253,0

The data in bold type relate to the standard versions of the relays.

Ordering codes

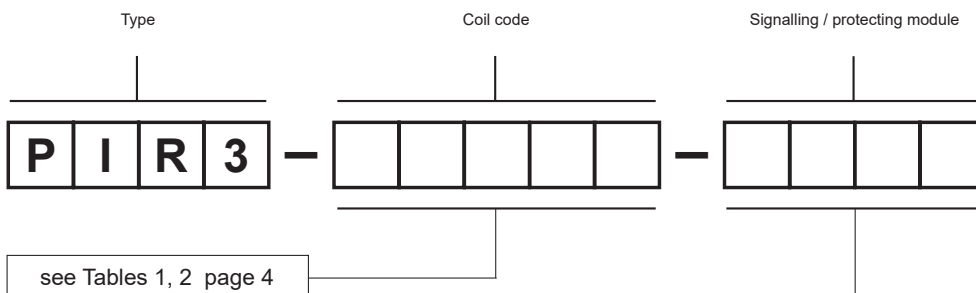

Signalling / protecting module

- 00LD - M41G - module LD (LED green + diode D, polarization N: +A1/-A2), 6/24 V DC
- 00LD - M42G - module LD (LED green + diode D, polarization N: +A1/-A2), 24/60 V DC
- 00LD - M43G - module LD (LED green + diode D, polarization N: +A1/-A2), 110/230 V DC
- 00LV - M91G - module LV (LED green + varistor), 6/24 V AC/DC
- 00LV - M92G - module LV (LED green + varistor), 24/60 V AC/DC
- 00LV - M93G - module LV (LED green + varistor), 110/240 V AC/DC

Examples of ordering codes:

PIR3-012DC-00LD

interface relay **PIR3** consists of: relay **R3N** (three changeover contacts, contact material AgNi, coil voltage 12 V DC), socket **GZM3** (grey, screw terminals), signalling / protecting module **M41G** (version LD), retainer / retractor clip **GZT4-0040** (plastic), description plate **GZT4-0035** (white)

PIR3-230AC-00LV

interface relay **PIR3** consists of: relay **R3N** (three changeover contacts, contact material AgNi, coil voltage 230 V AC 50/60 Hz), socket **GZM3** (grey, screw terminals), signalling / protecting module **M93G** (version LV), retainer / retractor clip **GZT4-0040** (plastic), description plate **GZT4-0035** (white)

PRECAUTIONS:

1. Ensure that the parameters of the product described in its specification provide a safety margin for the appropriate operation of the device or system and never use the product in circumstances which exceed the parameters of the product. 2. Never touch any live parts of the device. 3. Ensure that the product has been connected correctly. An incorrect connection may cause malfunction, excessive heating or risk of fire. 4. In case of any risk of any serious material loss or death or injuries of humans or animals, the devices or systems shall be designed so to equip them with double safety system to guarantee their reliable operation.

Interconnection strips ZGGZ4



PIR2-...-00L.
(R2N + GZM2)

ZGGZ4

■ ZGGZ4 for:

Plug-in sockets	Relays for plug-in sockets	Interface relays ^①
GZM2	R2N	PIR2-...-00L. (R2N + GZM2)
GZT2		
GZM3	R3N	PIR3-...-00L. (R3N + GZM3)
GZT3		
GZM4	R4N	PIR4-...-00L. (R4N + GZM4)
GZT4		

^① Interface relay **PIR2 (PIR3, PIR4)** is offered as a **set**: electromagnetic relay **R2N (R3N, R4N)** + plug-in socket **GZM2 (GZM3, GZM4)** + signalling / protecting module type **M...** + retainer / retractor clip **GZT4-0040** + description plate **GZT4-0035**.

■ Interconnection strip ZGGZ4

- designed for the co-operation with plug-in sockets of miniature industrial relays and with interface relays PIR2, PIR3 and PIR4, which are equipped with screw terminals; sockets and relays are mounted on 35 mm rail mount acc. to EN 60715,
- bridges common input signals (coil terminals A1 or A2) or output signals - see photo at the top,
- maximum permissible current is 10 A / 250 V AC,
- possibility of connection of 6 sockets or relays,
- colours of strips: **ZGGZ4-1** grey, **ZGGZ4-2** black.

